

# **JAYDEE** ENTERPRISES INC.

3465 LOST NATION ROAD, UNIT 15, WILLOUGHBY, OH 44094  
TOLL FREE 800-989-0162 ~ ~ 440-946-9367 ~ ~ FAX 440-946-6148  
E-MAIL: SALES@JDV-BELTS.COM ~ ~ VISIT OUR WEBSITE: WWW.JDV-BELTS.COM



## **REPLACEMENT PARTS AND ACCESSORIES FOR OUTDOOR POWER EQUIPMENT**



**A COMPREHENSIVE INTERCHANGE -  
PRICE LIST AND FULL CATALOG**

### **Residential/Commercial Mowers**



### **Chippers - Shredders**



### **Tillers - Tractors - Edger's**



### **Snow Throwers - ATV's**

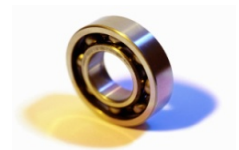

### **Go Karts - Mini Bikes**

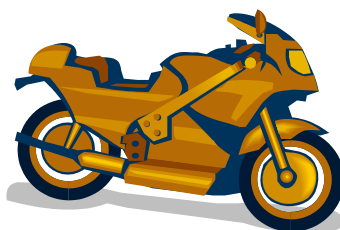

**QUALITY PARTS AT ECONOMICAL PRICES!!**

# INDEX



<u>PRODUCTS</u>	<u>PAGE NUMBERS</u>
Bearings	1 - 28
Bearing Kits	29 - 31
Bushing and Spacers	32 - 43
Replacement Blades	44 - 117
Edger Blades	118 - 126
Air Filters	127 - 194
Fuel Filters	195 - 210
Oil and Transmission Filters	211 - 215
Oil Accessories	216
Go Kart - ATV- Mini Bike Parts	217 - 222
Drive Pulleys	223 - 233
Idlers Pulleys	234 - 256
Universal Pulleys	257 - 263
Hydrostatic Pumps and Motors	264 - 270
Snow Thrower Parts	271 - 274
Snow Thrower Belts	275 - 277
Spindles	278 - 293
Tires and Tubes	294 - 307
Tire Chains	308

## TERMS AND CONDITIONS OF SALE

1. F.O.B. is Willoughby, OH USA.
2. We accept Visa, MasterCard, and Discover and will ship C.O.D. Open account terms are based on credit references and banking information, subject to JayDee Enterprises approval and acceptance. Negotiated terms are Net 30 days.
3. Quantities may be shipped +/- 5%.
4. Shortage or overcharge claims must be made within 10 days after goods are received.
5. ***Return goods will not be accepted without prior permission.*** Freight is to be prepaid and handling charges may be levied pending inspection of the returned goods.
6. Material defective through workmanship or faulty materials will be replaced. Labor and consequential damages cannot be honored.
7. \$20.00 minimum order on domestic orders using terms.
8. A restocking **charge of 20%** may be applied pending inspections and authorization of materials returned.
9. All prices are subject to change without notice.
10. We will **not** accept the return of any product with a purchase date over (1) year.

***Note: Possession of this catalog and/or price list does not necessarily entitle the holder to receive these prices.***

## Allis Chalmers



	Bearing No.	ID	OD	Height	Oregon	Rotary	Stens	Price
	<b>B1SB484</b> 536986 - Ball bearing.							
	Z9504-RST	3/4"	1-25/32"	19/32"	45-402	484	230-160	\$3.60
	<b>B1SB442</b> 1652231 - Ball bearing.							
	6204-RS	25/32"	1-27/32"	9/16"	45-403	442	230-029	\$3.00

## Ariens





	Bearing No.	ID	OD	Height	Oregon	Rotary	Stens	Price
	<b>B1MT61</b> 05408000 - Ball bearing. Fits Fairway, LM21, ST4, ST5, ST524, ST624, ST7, ST724, ST8, and ST832 models							
	1621-2RS	1/2"	1-3/8"	7/16"	--	8869	230-276	\$3.80
	<b>B1SB481</b> 05408900, 05415100, 05416200 - Ball bearing. Double sealed. Packaged in lots of 10. Includes clip. Precision high-speed bearing.							
	499502H-NR	5/8"	1-3/8"	7/16"	45-202	481	215-202	\$6.00
	<b>B1SB1265</b> 05403900, 05435100 - Ball Bearing. Fits 24" and 32" snow thrower drive train attachment.							
	99502H-RST	5/8"	1-3/8"	7/16"	45-202	1265	230-019	\$4.00
	<b>B1SB483</b> 05418800 - Ball bearing. Fits 93700 series snow throwers.							
	6203-2RS	5/8"	1-9/16"	15/32"	45-203	483	230-011	\$2.50
	<b>B1AC61</b> 05418800 - Ball bearing. Fits 93700 series snow throwers.							
	6203-ZZ	21/32"	1-9/16"	15/32"	45-624	7917	230-060	\$2.30
	<b>B1RS46</b> 05418800 - Ball Bearing. Fits 93700 series snow throwers.							
	6203 RS/C3	21/32"	1-9/16"	15/32"	45-257	8507	230-060	\$2.50
	<b>B1SB484</b> 05407300, 05412000 - Ball Bearing. Fits Emperor 6-10HP, Fairway 4-10HP, and 48" snow throwers							
	Z9504-RST	3/4"	1-25/32"	19/32"	45-402	484	230-160	\$3.60
	<b>B1SB328</b> 05408900, 05416200 - Ball Bearing. Fits Emperor, LM21, LT832, RM1032, RM1132, RM1230, RM1232, RM828, RM830, SRM626, YT1032, YT1132, YT1138, YT1238, YT1438, and YT832. Package quantity: 5.							
	--	3/4"	1-3/8"	1/2"	45-234	328	230-128	\$4.20
	<b>B1SB487</b> 05406300 - Ball Bearing. Sealed high speed bearing for snow throwers.							
	SC0493LU	3/4"	1-3/4"	1/2"	45-035	487	230-045	\$17.00

Bearings



**Ariens**

	Bearing No.	ID	OD	Height	Oregon	Rotary	Stens	Price
	<b>B1SB813</b> <b>05404400, 05404500</b> - Roller Bearing. Fits FT524, RT214, RT424, RT5020, ST424, ST624, ST724, ST732, ST1032, ST1124, ST1152, YT1138, and YT1238 mowers, tillers and snow throwers. Includes race.							
	LM11949/10	3/4"	1.781"	.61"	45-206	813	230-929	\$4.90
	<b>B1SB442</b> <b>05412300</b> - Ball Bearing.							
	6204-RS	25/32"	1-27/32"	9/16"	45-403	442	230-029	\$3.00
	<b>B1SB814</b> <b>05407000, 05406900</b> - Roller Bearing. Fits tillers, snow throwers, and PM34 and Zoom mowers. Includes race.							
	L44643/10	1"	1.98"	.56"	45-002	814	215-285	\$5.40

**AYP**

	Bearing No.	ID	OD	Height	Oregon	Rotary	Stens	Price
	<b>B1SB483</b> <b>110485X</b> - Ball Bearing. Fits our B1RS25 spindle.							
	6203-2RS	5/8"	1-9/16"	15/32"	45-203	483	230-011	\$2.50
	<b>B1AC61</b> <b>110485, 110485X</b> - Ball bearing. Fits our B1AY25, B1AY30, B1RS25 and B1RS30 spindles.							
	6203-ZZ	21/32"	1-9/16"	15/32"	45-624	7917	230-060	\$2.30
	<b>B1RS46</b> <b>110485, 110485X</b> - Ball Bearing. Fits our B1AY25, B1AY30, B1RS25, and B1RS30 spindles.							
	6203 RS/C3	21/32"	1-9/16"	15/32"	45-257	8507	230-060	\$2.50
	<b>B1SB813</b> <b>1553H, 1554H</b> - Roller Bearing. Includes race.							
	LM11949/10	3/4"	1.781"	.61"	45-206	813	230-929	\$4.90
	<b>B1SB442</b> <b>129895</b> - Ball Bearing. Fits model 917.270722. Bottom bearing on our B1RS21 spindle shaft.							
	6204-RS	25/32"	1-27/32"	9/16"	45-403	442	230-029	\$3.00

**Bad Boy**







	Bearing No.	ID	OD	Height	Oregon	Rotary	Stens	Price
	<b>B1SB481</b> <b>022-7009-00</b> - Ball Bearing. Fits wheel assemblies on AOS, Lightning, Pup, and ZT. Packaged in lots of 10. Includes clip.							
	499502H-NR	5/8"	1-3/8"	7/16"	45-202	481	215-202	\$3.40
	<b>B1SB814</b> <b>010-7001-00, 011-7002-00</b> - Roller Bearing. Fits caster yokes on AOS, Lightning, Pup, and ZT. Includes race.							
	L44643/10	1"	1.98"	.56"	45-002	814	215-285	\$5.40



## Blue Bird

	Bearing No.	ID	OD	Height	Oregon	Rotary	Stens	Price
	<b>B1SB8863</b> <b>0315</b> - Ball Bearing. Fits models F20 and F20B, dethatchers, overseeders, and aerators. Includes locking collar and set screw.							
	SA204-012	3/4"	1-27/32"	27/32"	45-201	8863	225-680	\$7.80

## Bobcat

	Bearing No.	ID	OD	Height	Oregon	Rotary	Stens	Price
	<b>B1SB1265</b> <b>38046N</b> - Ball Bearing. Fits models with variable speed transmissions. Fits our B1C0100 gearbox.							
	99502H-RST	5/8"	1-3/8"	7/16"	45-202	1265	230-019	\$4.00
	<b>B1SB483</b> <b>48094A</b> - Ball Bearing. Fits idler pulleys on Cutterdeck BZT, FM48, FM61 and FM74.							
	6203-2RS	5/8"	1-9/16"	15/32"	45-203	483	230-011	\$2.50
	<b>B1CO49</b> <b>35006N, 35062B</b> - Ball bearing. Output shaft support bracket bearing for 32", 36", and 48" decks. Includes locking collar and set screws.							
	SB202-10	5/8"	1-9/16"	7/8"	48-211	8077	230-056	\$2.50
	<b>B1SB6534</b> <b>148042</b> - Ball Bearing. Flanged. Fits wheel assemblies on 5 speed units.							
	--	1"	2"	9/16"	45-031	6534	230-237	\$12.20
	<b>B1IH94</b> <b>38348-01</b> - Ball Bearing. Fits 36", 48", and 61" XM mowers. Includes collar.							
	CSA20516	1"	2-3/64"	27/32"	45-225	8488	225-217	\$10.20
	<b>B1CO17</b> <b>35008N</b> - Ball Bearing. Fits spindles on FM48, FM61, FM74, M36, M 48, R48, R54, T16, T186, and XM series mowers.							
	6305-2RS	1"	2-7/16"	21/32"	45-401	3217	230-086	\$5.70

## Bolens





	Bearing No.	ID	OD	Height	Oregon	Rotary	Stens	Price
	<b>B1SB813</b> <b>118-5275</b> - Roller Bearing. Includes race.							
	LM11949/10	3/4"	1.781"	0.61"	45-206	813	230-929	\$4.90

## Briggs &amp; Stratton



	Bearing No.	ID	OD	Height	Oregon	Rotary	Stens	Price
	<b>B1SB442</b> <b>99158</b> - Ball Bearing. Fits 083152-097452, 120202-12T292, 13H132-13H362. Gear reduction.							
	6204-2RS	25/32"	1-27/32"	9/16"	45-403	442	230-029	\$3.00

Bearings

**Bunton**

	Bearing No.	ID	OD	Height	Oregon	Rotary	Stens	Price
	<b>B1SB1265</b> <b>PL0678, PL4969</b> - Ball Bearing. Fits models with variable speed transmissions. Fits our B1CO100 gearbox.							
	99502H-RST	5/8"	1-3/8"	7/16"	45-202	1265	230-019	\$4.00
	<b>B1CO49</b> <b>PL0878</b> - Ball Bearing. Output shaft support bracket bearing for 32", 36", and 48" decks, variable speed units.							
	SB202-10	5/8"	1-9/16"	7/8"	48-211	8077	230-056	\$7.30
	<b>B1SB328</b> <b>PO209, PL0941</b> - Ball Bearing. Package quantity: 5.							
	--	3/4"	1-3/8"	1/2"	45-234	328	230-128	\$4.20
	<b>B1IH94</b> <b>PL7323</b> - Ball Bearing. Includes collar.							
	CSA20516	1"	2-3/64"	27/32"	45-225	8488	225-217	\$8.40
	<b>B1CO17</b> <b>PL0609, PL4609, PL6141</b> - Ball Bearing.							
	6305-2RS	1"	2-7/16"	21/32"	45-401	3217	230-086	\$5.70

**Case**

	Bearing No.	ID	OD	Height	Oregon	Rotary	Stens	Price
	<b>B1SB484</b> <b>C28971</b> - Ball Bearing							
	Z9504-RST	3/4"	1-25/32"	19/32"	45-402	484	230-160	\$3.60
	<b>B1SB328</b> <b>384881-R93, 384881-R94, C12110</b> - Ball Bearing. Package quantity: 5							
	--	3/4"	1-3/8"	1/2"	45-234	328	230-128	\$4.20





**Club Car**

	Bearing No.	ID	OD	Height	Oregon	Rotary	Stens	Price
	<b>B1SB813</b> <b>7274</b> - Roller Bearing. Fits front-wheel hub. Includes race.							
	LM11949 /10	3/4"	1.781"	.61"	45-206	813	230-929	\$4.90







**Country Clipper**

	Bearing No.	ID	OD	Height	Oregon	Rotary	Stens	Price
	<b>B1AC229</b> <b>C-28971</b> - Ball Bearing. Fits Spindles.							
	6205-2RS	31/32"	2-1/32"	19/32"	45-227	7162	230-102	\$3.80

## Cub Cadet







	Bearing No.	ID	OD	Height	Oregon	Rotary	Stens	Price	
	<b>B1SB484</b> 456003-R91, 470880-R91, IH470880-R91 - Ball bearing.	Z9504-RST	3/4"	1-25/32"	19/32"	45-402	484	230-160	\$3.60
	<b>B1SB328</b> IH-384891-R94 - Ball Bearing. Package quantity: 5.	--	3/4"	1-3/8"	1/2"	45-234	328	230-128	\$4.20
	<b>B1SB813</b> 473430 R91, 651814-R1, 651815-R91, 741-3029, IH-473430-R91 - Roller Bearing. Includes race.	LM11949/10	3/4"	1.781"	.61"	45-206	813	230-929	\$4.90
	<b>B1SB442</b> ST207, SU-9001310-0001 - Ball Bearing.	6204-2RS	25/32"	1-27/32"	9/16"	45-403	442	230-029	\$3.00
	<b>B1IH94</b> 455102-R21, 586609-R92, 60069C91, IH-455102-R21, IH-586609-R92, IH-60071-C91, IH60071-C92 - Ball Bearing. Fits 100, 102, 122, and 123 models. Includes collar.	CSA20516	1"	2-3/64"	27/32"	45-225	8488	225-217	\$8.40

## Cushman





	Bearing No.	ID	OD	Height	Oregon	Rotary	Stens	Price	
	<b>B1SB1265</b> 812899 - Ball Bearing. Fits Truckster models.	99502H-RST	5/8"	1-3/8"	7/16"	45-202	1265	230-019	\$4.00
	<b>B1SB483</b> 832498 - Ball Bearing.	6203-2RS	5/8"	1-9/16"	15/32"	45-203	483	230-011	\$2.50
	<b>B1AC61</b> 832498 - Ball Bearing.	6203-ZZ	21/32"	1-9/16"	15/32"	45-624	7917	230-060	\$2.30
	<b>B1RS46</b> 832498 - Ball Bearing	6203-2RS	21/32"	1-9/16"	15/32"	45-257	8507	230-060	\$2.50
	<b>B1SB813</b> 385174, 808089, 815403 - Roller Bearing. Fits Truckster models. Includes race.	LM11949/10	3/4"	1.781"	.61"	45-206	813	230-929	\$4.90
	<b>B1SB814</b> 814473, 814474 - Roller Bearing. Includes race.	L44643/10	1"	1.98"	.56"	45-002	814	215-285	\$5.40

Bearings



**Dixie Chopper**

	Bearing No.	ID	OD	Height	Oregon	Rotary	Stens	Price	
	<b>B1SB1265</b> <b>67205</b> - Ball Bearing. Fits wheel assemblies on Classic, Flatlander, Silver Eagle, and Xtreme.								
	99502H-RST	5/8"	1-3/8"	7/16"	45-202	1265	230-019	\$4.00	
	<b>B1CO7950</b> <b>10205</b> - Ball Bearing. Flanged. Fits wheel assemblies on models with 50" and 60" decks.								
	--	5/8"	1-3/8"	1/2"	45-258	7950	215-370	\$9.70	
	<b>B1SB814</b> <b>10206, 10207</b> - Roller Bearing. Fits caster yokes on Classic, Flatlander, Silver Eagle, and Xtreme models.								
	L44643/10	Includes race.		1"	1.98"	.56"	45-002	814	215-285
	<b>B1IH94</b> <b>30218</b> - Ball Bearing. Fits spindles on Classic, Flatlander, Silver Eagle and Xtreme models. Incles collar.								
	CSA20516	1"	2-3/64"	27/32"	45-225	8488	225-217	\$8.40	
	<b>B1DC22</b> <b>30218</b> - Ball Bearing. Fits spindles on Classic, Flatlander, Silver Eagle, and Xtreme models.								
	--	1"	2-7/16"	7/8"	--	9937	--	\$7.80	
	<b>B1DC23</b> <b>97171</b> - Roller Bearing. Fits caster yokes on Classic, Flatlander, Silver Eagle, and Xtreme models.								
	LM44649/10	Includes race.		1-1/8"	2"	5/8"	--	9951	--



**Dixon**

	Bearing No.	ID	OD	Height	Oregon	Rotary	Stens	Price
	<b>B1SB481</b> <b>5028, 539125206</b> - Ball Bearing. Precision high-speed bearing. Double sealed. Packaged in lots of 10.							
	499502H-NR	5/8"	1-3/8"	7/16"	45-202	481	215-202	\$3.40
	<b>B1DX100</b> <b>5429, 539 115982</b> - Ball Bearing.							
	62032RS	5/8"	1-9/16"		45-130	8437	--	\$2.50
	<b>B1SB484</b> <b>539 125515, 6011</b> - Ball Bearing							
	Z9504-RST	3/4"	1-25/32"	19/32"	45-402	484	230-160	\$3.60
	<b>B1SB6535</b> <b>539 125582, 6151</b> - Ball Bearing.							
	6203-2RS	3/4"	1-9/16"	15/32"	45-005	6535	230-052	\$2.50
	<b>B1IH94</b> <b>1701, 539 115279</b> - Ball Bearing. Fits 44" and 50" ZTR Ram blower. Includes collar.							
	CSA20516	1"	2-3/64"	27/32"	45-225	8488	225-217	\$8.40





## Dolmar

	Bearing No.	ID	OD	Height	Oregon	Rotary	Stens	Price
	<b>B1SB483</b> <b>960 102 176</b> - Ball Bearing. Fits PC-64XX, PC-73XX, and PC-81XX model cutoff saws.							
	6203-2RS	5/8"	1-9/16"	15/32"	45-203	483	230-011	\$2.50
	<b>B1AC61</b> <b>960 102 176</b> - Ball Bearing. Fits PC-64XX, PC-73XX, and PC-81XX model cutoff saws.							
	6203-ZZ	21/32"	1-9/16"	15/32"	45-624	7917	230-060	\$2.30
	<b>B1RS46</b> <b>960 102 176</b> - Ball Bearing. Fits PC-64XX, PC-73XX, and PC-81XX model cutoff saws.							
	6203-2RS	21/32"	1-9/16"	15/32"	45-257	8507	230-060	\$2.50

## Encore



	Bearing No.	ID	OD	Height	Oregon	Rotary	Stens	Price
	<b>B1SB6534</b> <b>363187</b> - Ball Bearing. Flanged. Fits wheel assemblies on 5 speed walk-behind units.							
	--	1"	2"	9/16"	45-031	6534	230-237	\$12.20
	<b>B1CO17</b> <b>363146, 363350</b> - Ball Bearing. Fits Fuzion Frontcut, Fuzion Midcut, Premier HydroPro, Premier Pro, and Prowler Midcut.							
	6305-2RS	1"	2-7/16"	21/32"	45-401	3217	230-086	\$5.70

## Exmark



	Bearing No.	ID	OD	Height	Oregon	Rotary	Stens	Price
	<b>B1SB8351</b> <b>1-513009, 1-631560</b> - Ball Bearing. Fits front caster wheels on Explorer and Lazer Z models.							
	--	1/2"	1-3/8"	1/2"	45-038	8351	230-241	\$12.30
	<b>B1SB1265</b> <b>1-303051</b> - Ball Bearing. Fits our B1CO100. Gearbox.							
	99502H-RST	5/8"	1-3/8"	7/16"	45-202	1265	230-019	\$4.00
	<b>B1CO49</b> <b>1-303067</b> - Ball Bearing. Output shaft support bracket bearing for 32", 36", and 48" decks, variable speed units.							
	SB202-10	5/8"	1-9/16"	7/8"	48-211	8077	230-056	\$7.30
	<b>B1SB813</b> <b>1-633585</b> - Roller Bearing. Fits our B1WL35, B1WL36, and B1FP109 wheel assemblies. Used in our B1EM150 bearing kit. Includes race.							
	LM11949/10	3/4"	1.781"	.61"	45-206	813	230-929	\$4.90
	<b>B1SB814</b> <b>1-543509</b> - Roller Bearing. Fits Lazer Z, Lazer Z AS, Lazer Z HP, Lazer Z XP, Lazer Z XS, Metro HP, Turf Ranger, Turf Tracer Hydro. Includes Race.							
	L44643/10	1"	1.98"	.56"	45-002	814	215-285	\$5.40

Bearings





Exmark

	Bearing No.	ID	OD	Height	Oregon	Rotary	Stens	Price
	<b>B1SB6534</b> 1-323329 - Ball Bearing. Flanged. Fits wheel assemblies on Metro models.							
	--	1"	2"	9/16"	45-031	6534	230-237	\$12.20
	<b>B1CO17</b> 1-303057, 1-303543, 1-363173 - Ball Bearing. Fits Lazer Z.							
	6305-2RS	1"	2-7/16"	21/32"	45-401	3217	230-086	\$5.70

EZ-GO

	Bearing No.	ID	OD	Height	Oregon	Rotary	Stens	Price
	<b>B1SB813</b> 1011393, 1170G1, 3523903, 50908-G1 - Roller Bearing. Fits front wheels on 74-03 Club Car DS Gas and Electric. Includes race.							
	LM11949/10	3/4"	1.781"	.61"	45-206	813	230-929	\$4.90
	<b>B1SB814</b> 11750G2, 50892G1, 51141-81 - Roller Bearing. Fits front wheels on carts with 1" spindle. Includes race.							
	L44643/10	1"	1.98"	.56"	45-002	814	215-285	\$5.40

Ferris





	Bearing No.	ID	OD	Height	Oregon	Rotary	Stens	Price
	<b>B1SB483</b> 5020827 - Ball Bearing. Fits Hydrowalk DD, IS3000Z, IS4000Z, IS4500Z, IS5100Z, and ProCut 30.							
	6203-2RS	5/8"	1-9/16"	15/32"	45-203	483	230-011	\$2.50
	<b>B1SB813</b> 5022631SX2 - Roller Bearing. Fits wheel assemblies on 1000Z, IS1000Z, IS1500Z, IS1500ZX, IS2000Z, IS3000Z, IS3100Z, IS4500Z, IS5000Z and IS5100Z. Includes race.							
	LM11949/10	3/4"	1.781"	.61"	45-206	813	230-929	\$4.90
	<b>B1SB814</b> 20884, 5020883, 5020884 - Roller Bearing. Fits wheels and caster yokes on IS1500ZX, IS2000Z, IS3100Z, IS4500Z, IS5000Z, and ProCut S. Includes race.							
	L44643/10	1"	1.98"	.56"	45-002	814	215-285	\$5.40
	<b>B1CO17</b> 1520828, 5020828 - Ball Bearing. Fits our B1CO73 spindle. Fits HydroWalk DD, HydroWalk SD, IS4000Z, IS5000Z, ProCut 30, and UltraBelt GD.							
	6305-2RS	1"	2-7/16"	21/32"	45-401	3217	230-086	\$5.70

Ford







	Bearing No.	ID	OD	Height	Oregon	Rotary	Stens	Price
	<b>B1SB813</b> 8A1216B - Roller Bearing. Includes race.							
	LM11949/10	3/4"	1.781"	.61"	45-206	813	230-929	\$4.90



## Gilson

	Bearing No.	ID	OD	Height	Oregon	Rotary	Stens	Price
	<b>B1AC61</b> 236544 - Ball Bearing							
	6203-ZZ	21/32"	1-9/16"	15/32"	45-624	7917	230-060	\$2.30
	<b>B1RS46</b> 236544 - Ball Bearing.							
	6203-2RS	21/32"	1-9/16"	15/32"	45-257	8507	230-060	\$2.50
	<b>B1SB813</b> 1044, 1140 - Roller Bearing. Fits Gilson tillers. Includes race.							
	LM11949/10	3/4"	1.781"	.61"	45-206	813	230-929	\$4.90
	<b>B1SB814</b> 1045, 1046 - Roller Bearing. Fits Gilson tillers. Includes race.							
	L44643/10	1"	1.98"	.56"	45-002	814	215-285	\$5.40







## Grasshopper

	Bearing No.	ID	OD	Height	Oregon	Rotary	Stens	Price
	<b>B1CO7950</b> 120050 - Ball Bearing. Flanged. Fits 6372, 9048, and 9061 models.							
	--	5/8"	1-3/8"	1/2"	45-258	7950	215-370	\$9.70
	<b>B1AC229</b> 110082, 833210 - Ball Bearing. Fits 9544, 9548, 9552, 9561, and 9572 models.							
	6205-2RS	31/32"	2-1/32"	19/32"	45-227	7162	230-102	\$3.80
	<b>B1SB814</b> 122552 - Roller Bearing. Includes race.							
	L44643/10	1"	1.98"	.56"	45-002	814	215-285	\$5.40
	<b>B1GH25</b> 110082 - Ball Bearing. Fits spindle assemblies.							
	6205-RST	1"	2"	19/32"	45-032	10303	--	\$6.30
	<b>B1IH94</b> 120081 - Ball Bearing. Fits 9048, 52" and 61" decks. Includes collar.							
	CSA20516	1"	2-3/64"	27/32"	45-225	8488	225-217	\$8.40
	<b>B1GH50</b> 122043, 122044 - Ball Bearing. Pillow block bearing for 700 and 900 series. Includes grease fitting.							
	UC205-16	1"	5-1/2"	2-3/4"	--	9160	230-437	\$9.20





Bearings



Gravely

	Bearing No.	ID	OD	Height	Oregon	Rotary	Stens	Price
	<b>B1SB481</b> <b>036778</b> - Ball Bearing. Precision high-speed bearing. Double sealed. Packaged in lots of 10. Includes clip.							
	499502H-NR	5/8"	1-3/8"	7/16"	45-202	481	215-202	\$3.40
	<b>B1SB328</b> <b>011193, 01122800, 036778, 05408900, 05415100, 05416200, 20067500, 2063770</b> - Ball Bearing. Fits Emperor, LM, LT, SRM, RM, and YT models. Package quantity: 5.							
	--	3/4"	1-3/8"	1/2"	45-234	328	230-128	\$4.20
	<b>B1SB6573</b> <b>011193, 037823</b> - Ball Bearing. Flanged.							
	PRF122214-2RS	3/4"	1-3/8"	1/2"	45-010	6573	--	\$8.30
	<b>B1SB813</b> <b>01844500, 01844600</b> - Roller Bearing. Fits 831026-001501 60" deck and 831038-000585 42" deck.							
	LM11949/10	3/4"	1.781"	.61"	45-206	813	230-929	\$4.90
	<b>B1SB814</b> <b>038199</b> - Roller Bearing. Includes race.							
	L44643/10	1"	1.98"	.56"	45-002	814	215-285	\$5.40
	<b>B1CO17</b> <b>012984</b> - Ball Bearing.							
	6305-2RS	1"	2-7/16"	21/32"	45-401	3217	230-086	\$5.70

Great Dane

	Bearing No.	ID	OD	Height	Oregon	Rotary	Stens	Price
	<b>B1SB814</b> <b>D28051, D28052</b> - Roller Bearing. Fits caster yokes on Chariot Jr., Chariot Sr., Super Surfer, and Super Surfer II. Includes race.							
	L44643/10	1"	1.98"	.56"	45-002	814	215-285	\$5.40
	<b>B1CO17</b> <b>200046, D18045</b> - Ball Bearing. Fits our B1GR5 spindle. Fits Chariot, Scamper, and Super Surfer.							
	6305-2RS	1"	2-7/16"	21/32"	45-401	3217	230-086	\$5.70

Honda

	Bearing No.	ID	OD	Height	Oregon	Rotary	Stens	Price
	<b>B1WB10</b> <b>96150-60020-10, 0876904</b> - Ball Bearing. Fits 21" commercial mowers. Sealed 2 sides.							
	6002-2RS	37/64"	1-1/4"	23/64"	45-004	8525	--	\$2.60
	<b>B1SB484</b> <b>91102-VA4-003</b> - Ball Bearing. Fits spindles.							
	Z9504-RST	3/4"	1-25/32"	19/32"	45-402	484	230-160	\$3.60

## Honda

	Bearing No.	ID	OD	Height	Oregon	Rotary	Stens	Price
	<b>B1SB442</b> <b>91102-VA4-013, 3175999</b> - Ball Bearing. Top crank bearing.							
	6204-2RS	25/32"	1-27/32"	9/16"	45-403	442	230-029	\$3.00

## Husqvarna

	Bearing No.	ID	OD	Height	Oregon	Rotary	Stens	Price
	<b>B1MT61</b> <b>606 00 01-84</b> - Ball Bearing. Fits models 824 snow throwers.							
	1621-2RS	1/2"	1-3/8"	7/16"	--	8869	230-276	\$3.80
	<b>B1CO7950</b> <b>606 00 01-22</b> - Ball Bearing. Flanged.							
	--	5/8"	1-3/8"	1/2"	45-258	7950	215-370	\$9.70
	<b>B1SB483</b> <b>532 11 04-85</b> - Ball Bearing.							
	6203-2RS	5/8"	1-9/16"	15/32"	45-203	483	230-011	\$2.50
	<b>B1AC61</b> <b>532 11 04-85</b> - Ball Bearing.							
	6203-ZZ	21/32"	1-9/16"	15/32"	45-624	7917	230-060	\$2.30
	<b>B1RS46</b> <b>532 11 04-85</b> - Ball Bearing.							
	6203-2RS	21/32"	1-9/16"	15/32"	45-257	8507	230-060	\$2.50
	<b>B1SB442</b> <b>532 12 98-95</b> - Ball Bearing. Fits our B1RS25 spindle.							
	6204-2RS	25/32"	1-27/32"	9/16"	45-403	442	230-029	\$3.00
	<b>B1SB814</b> <b>539 10 26-26</b> - Roller Bearing. Includes race.							
	L44643/10	1"	1.98"	.56"	45-002	814	215-285	\$5.40
	<b>B1IH94</b> <b>539 10 26-77, 539 1074-06</b> - Ball Bearing. Includes collar.							
	CSA20516	1"	2-3/64"	27/32"	45-225	8488	225-217	\$8.40

## Hustler







	Bearing No.	ID	OD	Height	Oregon	Rotary	Stens	Price
	<b>B1IH94</b> <b>077123, 784223</b> - Ball Bearing. Fits our B1HS14 spindle. Also fits caster yokes on 4500, 4600, ATZ, FasTrack, Hydro Walk-behind, Mini Z, Super Z, Trimstar, and Z models. Includes collar.							
	CSA20516	1"	2-3/64"	27/32"	45-225	8488	225-217	\$8.40

Bearings



Hustler

	Bearing No.	ID	OD	Height	Oregon	Rotary	Stens	Price
	<b>B1CO17</b> <b>783555</b> - Ball Bearing. Fits our B1HS100 spindle. Fits FasTrack Super Duty and Mini Z.							
	6305-2RS	1"	2-7/16"	21/32"	45-401	3217	230-086	\$5.70





Jacobsen

	Bearing No.	ID	OD	Height	Oregon	Rotary	Stens	Price
	<b>B1SB1265</b> <b>552234</b> - Ball Bearing. Fits Crew King. Fits our B1CO100 gearbox.							
	99502H-RST	5/8"	1-3/8"	7/16"	45-202	1265	230-019	\$4.00
	<b>B1CO49</b> <b>551849</b> - Ball Bearing. Output shaft support bracket bearing for 32", 36", and 48" decks, variable speed units.							
	SB202-10	5/8"	1-9/16"	7/8"	48-211	8077	230-056	\$7.30
	<b>B1SB813</b> <b>302010, 311960, 500534, 808089</b> - Roller Bearing. Fits Greensking II and IV, Trim King, Tri-King 1471, 1671, 1684D, LF100 and 3800. Includes race.							
	LM11949/10	3/4"	1.781"	.61"	45-206	813	230-929	\$4.90
	<b>B1AC229</b> <b>310427, 345050, 350759</b> - Ball Bearing. Fits Turfcut 50 and 60.							
	6205-2RS	31/32"	2-1/32"	19/32"	45-227	7162	230-102	\$3.80
	<b>B1SB6534</b> <b>182201</b> - Ball Bearing. Flanged. Fits wheel assemblies on mid-sized units.							
	--	1"	2"	9/16"	45-031	6534	230-237	\$12.20
	<b>B1CO17</b> <b>552184</b> - Ball Bearing. Fits Crew King.							
	6305-2RS	1"	2-7/16"	21/32"	45-401	3217	230-086	\$5.70

John Deere







	Bearing No.	ID	OD	Height	Oregon	Rotary	Stens	Price
	<b>B1MT61</b> <b>AM122108</b> - Ball Bearing. Fits 524D, 724D, 826D, 828D, and 1032D walk-behind snow throwers.							
	1621-2RS	1/2"	1-3/8"	7/16"	--	8869	230-276	\$3.80
	<b>B1SB1265</b> <b>AM122119</b> - Ball Bearing. Fits models with variable speed transmissions. Fits our B1CO100 gearbox.							
	99502H-RST	5/8"	1-3/8"	7/16"	45-202	1265	230-019	\$4.00
	<b>B1CO7950</b> <b>PT8894</b> - Ball Bearing. Flanged. Fits PC20003 32"-52" commercial walk-behind units.							
	--	5/8"	1-3/8"	1/2"	45-258	7950	215-370	\$9.70

## John Deere

	Bearing No.	ID	OD	Height	Oregon	Rotary	Stens	Price	
	<b>B1JD61</b> Cage Bearing. Roller cage bearing for our B1JD57 bearing kit.	--	5/8"	1-3/8"	2"	--	--	\$8.40	
	<b>B1JD62</b> Cage Bearing. Roller cage bearing for our B1JD57 bearing kit.	--	5/8"	1-3/8"	2-1/2"	--	--	\$8.60	
	<b>B1SB483</b> <b>JD8535</b> - Ball Bearing. Fits GT242, GT262, GT275, LX172, LX173, LX176, LX178, and LX188 models.	6203-2RS	5/8"	1-9/16"	15/32"	45-203	483	230-011	\$2.50
	<b>B1CO49</b> <b>PT8767</b> - Ball Bearing. Fits variable speed models.	SB202-10	5/8"	1-9/16"	7/8"	48-211	8077	230-056	\$7.30
	<b>B1AC61</b> <b>JD8535</b> - Ball Bearing. Fits GT242, GT262, GT275, LX172, LX173, LX176, LX178, and LX188 models.	6203-ZZ	21/32"	1-9/16"	15/32"	45-624	7917	230-060	\$2.30
	<b>B1RS46</b> <b>JD8535</b> - Ball Bearing. Fits GT242, GT262, GT275, LX172, LX173, LX176, LX178, and LX188 models.	6203-2RS	21/32"	1-9/16"	15/32"	45-257	8507	230-060	\$2.50
	<b>B1SB484</b> <b>JD9239, JD9296</b> - Ball Bearing. Fits model 3700 mower and models 520, 522, and 524 snow throwers.	Z9504-RST	3/4"	1-25/32"	19/32"	45-402	484	230-160	\$3.60
	<b>B1SB328</b> <b>AM118315, AM127304, AM35443</b> - Ball Bearing. Fits model 56, 57, 65, 66, 68, 100, 108, 111, 111H, 112L, 130, 160, 165, GX70, GX75, GX85, GX95, SRX75, SRX95, and SX85 mowers. Package quantity: 5.	--	3/4"	1-3/8"	1/2"	45-234	328	230-128	\$4.20
	<b>B1SB6573</b> <b>AM118315, AM35443</b> - Ball Bearing. Flanged.	PRF122214-2RS	3/4"	1-3/8"	1/2"	45-010	6573	--	\$8.30
	<b>B1SB6535</b> <b>AM122158</b> - Ball Bearing. Fits model 542D, 742D, 826D, 828D, 924DE, 1032D, 1128DE, 1128DDE, and 1332DDE walk-behind snow throwers.	6203-2RS	3/4"	1-9/16"	15/32"	45-005	6535	230-052	\$2.50
	<b>B1SB813</b> <b>AE24459, AM122120, JD8188</b> - Roller Bearing. Fits 2243, 2653, 3215, 3225, and 3365. Includes race.	LM11949/10	3/4"	1.781"	.61"	45-206	813	230-929	\$4.90

Bearings



**John Deere**

	Bearing No.	ID	OD	Height	Oregon	Rotary	Stens	Price
	<b>B1SB442</b> <b>JD10363, JD7677, JD9370</b> - Ball Bearing. Fits 140, 318, and 420 mowers.							
	6204-2RS	25/32"	1-27/32"	9/16"	45-403	442	230-029	\$3.00
	<b>B1AC229</b> <b>M63810, M88251</b> - Ball Bearing. Fits 160, 260, 261, and 272 rotary mowers. Fits 359 snow throwers. Fits 400 series 60" and 900 series 72" mid-mount mowers.							
	6205-2RS	31/32"	2-1/32"	19/32"	45-227	7162	230-102	\$3.80
	<b>B1SB814</b> <b>JD8253, JD8933</b> - Roller Bearing. Fits 46"-50" snow throwers; 303, 305, and 1500 model tillers. Includes race.							
	L44643/10	1"	1.98"	.56"	45-002	814	215-285	\$5.40
	<b>B1SB6534</b> <b>AM102605, AM33797</b> - Ball Bearing. Flanged. Fits wheel assemblies on 110, 112, 140, 200, 312, 314 316, 317, 318, 420, and 430 units.							
	--	1"	2"	9/16"	45-031	6534	230-237	\$12.20
	<b>B1IH94</b> <b>JD8597</b> - Ball Bearing. Fits 300-317 hydrostatic mowers and M653-M655 Z-tracks. Includes collar.							
	CSA20516	1"	2-3/64"	27/32"	45-225	8488	225-217	\$8.40
	<b>B1CO17</b> <b>JD9299, JD9467, M77534</b> - Ball Bearing. Fits PC2003 32"-52" commercial walk-behind units.							
	6305-2RS	1"	2-7/16"	21/32"	45-401	3217	230-086	\$5.70







**Kawasaki**

	Bearing No.	ID	OD	Height	Oregon	Rotary	Stens	Price
	<b>B1AC229</b> <b>92045-1163, 92045-1229</b> - Ball Bearing.							
	6205-2RS	31/32"	2-1/32"	19/32"	45-227	7162	230-102	\$3.80



**Kees**

	Bearing No.	ID	OD	Height	Oregon	Rotary	Stens	Price
	<b>B1SB1265</b> <b>363181</b> - Ball Bearing. Fits models with variable speed transmissions. Fits our B1CO100 gearbox.							
	99502H-RST	5/8"	1-3/8"	7/16"	45-202	1265	230-019	\$4.00
	<b>B1CO49</b> <b>363161</b> - Ball Bearing. Output shaft support bracket bearing for 32" and 48" decks, variable speed units							
	SB202-10	5/8"	1-9/16"	7/8"	48-211	8077	230-056	\$7.30
	<b>B1CO17</b> <b>363173, 919125</b> - Ball Bearing. Fits spindle assemblies.							
	6305-2RS	1"	2-7/16"	21/32"	45-401	3217	230-086	\$5.70



## Kubota

	Bearing No.	ID	OD	Height	Oregon	Rotary	Stens	Price
	<b>B1SB442</b> <b>08101-06204, PL501-12160</b> - Ball Bearing. Fits ZG23 Z-turn mowers							
	6204-2RS	25/32"	1-27/32"	9/16"	45-403	442	230-029	\$3.00
	<b>B1VPG5547</b> <b>66361-13320</b> - Thrust Bearing. Fits B2150 and B9200 with Single 216 engine type.							
	--	33.5 mm	70 mm	24 mm	--	--	--	\$60.00
	<b>B1VPG5546</b> <b>67311-13320</b> - Thrust Bearing. Fits B1550, B1750, B5200, B6200, and B7200 with Single 185 engine type; fits B20 and B8200 with Single 200 engine type.							
	--	33.5 mm	70 mm	24 mm	--	--	--	\$42.00
	<b>B1VPG5544</b> <b>37150-14820</b> - Thrust Bearing. Fits B1700, B2100, and B2400 models with Single 200 engine type.							
	--	40 mm	64 mm	16 mm	--	--	--	\$49.00
	<b>B1VPG5537</b> <b>38430-14820</b> - Thrust Bearing. Fits B2150 and B9200 with Dual 215/215 engine types							
	--	55 mm	84 mm	16 mm	--	--	--	\$26.00
	<b>B1VPG5540</b> <b>32530-14820</b> - Thrust Bearing. Fits L3750DT, L4550DT, and L4850DT with Dual 275/240 engine types.							
	--	60 mm	96 mm	22mm	--	--	--	\$67.00

## Lastec

	Bearing No.	ID	OD	Height	Oregon	Rotary	Stens	Price
	<b>B1SB813</b> <b>P-292</b> - Roller Bearing. Includes race.							
	LM11949/10	3/4"	1.781"	.61"	45-206	813	230-929	\$4.90
	<b>B1CO17</b> <b>P103</b> - Ball Bearing							
	6305-2RS	1"	2-7/16"	21/32"	45-401	3217	230-086	\$5.70



## Lawn Boy

	Bearing No.	ID	OD	Height	Oregon	Rotary	Stens	Price
	<b>B1SB483</b> <b>700479, 703275</b> - Ball Bearing.							
	6203-2RS	5/8"	1-9/16"	15/32"	45-203	483	230-011	\$2.50
	<b>B1AC61</b> <b>700479, 703275</b> - Ball Bearing.							
	6203-ZZ	21/32"	1-9/16"	15/32"	45-257	7917	230-060	\$2.30







Bearings

Lawn Boy



	Bearing No.	ID	OD	Height	Oregon	Rotary	Stens	Price	
	<b>B1RS46</b> 700479, 703275 - Ball Bearing.	6203-2RS	21/32"	1-9/16"	15/32"	45-257	8507	230-060	\$2.50
	<b>B1SB813</b> 254-78, 700417 - Roller Bearing. Includes race.	LM11949/10	3/4"	1.781"	.61"	45-206	813	230-929	\$4.90
	<b>B1SB814</b> 254-72, 254-94, 703210, 703809 - Roller Bearing. Includes race.	L44643/10	1"	1.98"	.56"	45-002	814	215-285	\$5.40

Lesco



	Bearing No.	ID	OD	Height	Oregon	Rotary	Stens	Price	
	<b>B1SB324</b> 050337 - Ball Bearing. Flanged. Package quantity: 5.	--	1/2"	1-1/8"	7/16"	45-112	324	215-012	\$1.40
	<b>B1SB481</b> 050357 Ball bearing. Precision high-speed bearing. Double sealed. Packaged in lots of 10. Includes clip	499502H-NR	5/8"	1-3/8"	7/16"	45-202	481	215-202	\$6.00
	<b>B1SB1265</b> 021870 Ball Bearing. Precision high-speed bearing. Double sealed. Packaged in lots of 10. Includes clip.	99502H-RST	5/8"	1-3/8"	7/16"	45-202	1265	230-019	\$7.00
	<b>B1SB326</b> 050312 - Ball Bearing. Flanged. Package quantity:5.	--	5/8"	1-3/8"	1/2"	45-258	326	215-038	\$1.80
	<b>B1CO49</b> 050012 - Ball Bearing. Fits variable speed models.	SB202-10	5/8"	1-9/16"	7/8"	48-211	8077	230-056	\$7.30
	<b>B1SB484</b> 050371 - Ball Bearing.	Z9504-RST	3/4"	1-25/32"	19/32"	45-402	484	230-160	\$3.60
	<b>B1SB327</b> 050327 - Ball Bearing. Flanged. Package quantity: 5.	--	3/4"	1-3/8"	1/2"	45-234	327	215-046	\$2.10
	<b>B1SB813</b> 010710 - Roller Bearing. Includes race.	LM11949/10	3/4"	1.781"	.61"	45-206	813	230-929	\$4.90





## Lesco

	Bearing No.	ID	OD	Height	Oregon	Rotary	Stens	Price	
	<b>B1SB442</b> <b>050384</b> - Ball Bearing.	6204-2RS	25/32"	1-27/32"	9/16"	45-403	442	230-029	\$3.00
	<b>B1CO17</b> <b>050397</b> - Ball Bearing.	6305-2RS	1"	2-7/16"	21/32"	45-401	3217	230-086	\$5.70



## Makita

	Bearing No.	ID	OD	Height	Oregon	Rotary	Stens	Price	
	<b>B1SB483</b> <b>960 102 176</b> - Ball Bearing. Fits DPC64XX, DPC73XX, and DPC81XX model cutoff saws.	6203-2RS	5/8"	1-9/16"	15/32"	45-203	483	230-011	\$2.50
	<b>B1AC61</b> <b>960 102 176</b> - Ball Bearing. Fits DPC64XX, DPC73XX, and DPC81XX model cutoff saws.	6203-ZZ	21/32"	1-9/16"	15/32"	45-624	7917	230-060	\$2.30
	<b>B1RS46</b> <b>960 102 176</b> - Ball Bearing. Fits DPC64XX, DPC73XX, and DPC81XX model cutoff saws.	6203-2RS	21/32"	1-9/16"	15/32"	45-257	8507	230-060	\$2.50

## Massey Ferguson

	Bearing No.	ID	OD	Height	Oregon	Rotary	Stens	Price	
	<b>B1SB813</b> <b>831054M1, 831055M1</b> - Roller Bearing. Includes race.	LM11949/10	3/4"	1.781"	.61"	45-206	813	230-929	\$4.90
	<b>B1SB442</b> <b>350396X1, N1568</b> - Ball Bearing.	6204-2RS	25/32"	1-27/32"	9/16"	45-403	442	230-029	\$3.00

## McLane

	Bearing No.	ID	OD	Height	Oregon	Rotary	Stens	Price	
	<b>B1SB1265</b> <b>2306</b> - Ball Bearing. Cutterhead bearing for 3-wheel and 4-wheel lawn edger and trimmers.	99502H-RST	5/8"	1-3/8"	7/16"	45-202	1265	230-019	\$4.00
	<b>B1CO7950</b> <b>2036</b> - Ball Bearing. Flanged cutterhead bearing for 3-wheel and 4-wheel lawn edger and trimmers.	--	5/8"	1-3/8"	1/2"	45-258	7950	215-370	\$9.70

Bearings





MTD

	Bearing No.	ID	OD	Height	Oregon	Rotary	Stens	Price	
	<b>B1SB324</b> 741-0262, 741-0484, 941-0484 - Ball Bearing. Flanged. Package quantity: 5.	--	1/2"	1-1/8"	7/16"	45-112	324	215-012	\$1.40
	<b>B1MT61</b> 741-0133 - Ball Bearing. Fits models 840, 850, 960 series.	1621-2RS	1/2"	1-3/8"	7/16"	--	8869	230-276	\$3.80
	<b>B1SB7241</b> 741-0404, 941-0404 - Needle Bearing. For variator. Fits variable speed pulley. Fits models 600 and 659 Also fits White, Master Cut and Yardman. Two per unit.	SCE99	9/16"	3/4"	9/16"	45-037	7241	225-449	\$10.80
	<b>B1SB1265</b> 741-0155, 941-0155 - Ball Bearing. Fits spindle assemblies on 020, 030, 406, 430, 700, 719, 730, 740, 756, and 766 series.	99502H-RST	5/8"	1-3/8"	7/16"	45-202	1265	230-019	\$4.00
	<b>B1CO7950</b> 741-0569, 941-0569 - Ball Bearing. Flanged.	--	5/8"	1-3/8"	1/2"	45-258	7950	215-370	\$9.70
	<b>B1SB483</b> 741-0524, 941-0524 - Ball Bearing.	6203-2RS	5/8"	1-9/16"	15/32"	45-203	483	230-011	\$2.50
	<b>B1AC61</b> 741-0124, 941-0124, 941-0600 - Ball Bearing. Fits variable speed pulleys.	6203-ZZ	21/32"	1-9/16"	15/32"	45-624	7917	230-060	\$2.30
	<b>B1RS46</b> 741-0124, 941-0124, 941-0600 - Ball Bearing. Fits variable speed pulleys.	6203-2RS	21/32"	1-9/16"	15/32"	45-257	8507	230-060	\$2.50
	<b>B1SB328</b> 741-0141, 941-0141 - Ball Bearing. Package quantity: 5.	--	3/4"	1-3/8"	1/2"	45-234	328	230-128	\$4.20
	<b>B1SB6573</b> 741-0141, 941-0141 - Ball Bearing. Flanged.	PRF122214-2RS	3/4"	1-3/8"	1/2"	45-010	6573	--	\$8.30
	<b>B1MT29</b> 941-0309 - Ball Bearing. Fits auger impellers on 22" and 40" snow throwers. Includes collars.	SA204-12	3/4"	1-55/64"	27/32"	--	10265	--	\$10.50





## MTD

	Bearing No.	ID	OD	Height	Oregon	Rotary	Stens	Price
	<b>B1SB442</b> 741-0919, 941-0919 - Ball Bearing.							
	6204-2RS	25/32"	1-27/32"	9/16"	45-403	442	230-029	\$3.00

## Murray

	Bearing No.	ID	OD	Height	Oregon	Rotary	Stens	Price
	<b>B1SB1265</b> Ball Bearing. Fits our B1SB2925 and B1MU52 quill assembly (bottom).							
	99502H-RST	5/8"	1-3/8"	7/16"	45-202	1265	230-019	\$4.00
	<b>B1SB483</b> 12325MA, 1255MA, 1501389MA, 43846MA, 49562MA, 782973MA - Ball Bearing. Fits our B1SB2925 spindle housing.							
	6203-2RS	5/8"	1-9/16"	15/32"	45-203	483	230-011	\$2.50
	<b>B1AC61</b> 12325MA, 1255MA, 1501389MA, 43846MA, 49562MA, 782973MA - Ball Bearing. Fits our B1SB2925 spindle housing.							
	6203-ZZ	21/32"	1-9/16"	15/32"	45-624	7917	230-060	\$2.30
	<b>B1RS46</b> 12325MA, 1255MA, 1501389MA, 43846MA, 49562MA, 782973MA - Ball Bearing. Fits our B1SB2925 spindle housing.							
	6203-2RS	21/32"	1-9/16"	15/32"	45-257	8507	230-060	\$2.50
	<b>B1SB442</b> 55541 - Ball Bearing.							
	6204-2RS	25/32"	1-27/32"	9/16"	45-403	442	230-029	\$3.00

## Noma

	Bearing No.	ID	OD	Height	Oregon	Rotary	Stens	Price
	<b>B1SB483</b> 49562 - Ball Bearing. Fits our B1SB1172 quill.							
	6203-2RS	5/8"	1-9/16"	15/32"	45-203	483	230-011	\$2.50
	<b>B1AC61</b> 49652 - Ball Bearing. Fits our B1SB1172 quill.							
	6203-ZZ	21/32"	1-9/16"	15/32"	45-624	7917	230-060	\$2.30
	<b>B1RS46</b> 49652 - Ball Bearing. Fits our B1SB1172 quill.							
	6203-2RS	21/32"	1-9/16"	15/32"	45-257	8507	230-060	\$2.50
	<b>B1SB484</b> 35384 - Ball Bearing.							
	Z9504-RST	3/4"	1-25/32"	19/32"	45-402	484	230-160	\$3.60

Bearings

**Noma**

	Bearing No.	ID	OD	Height	Oregon	Rotary	Stens	Price
	<b>B1SB6535</b> 12325 - Ball Bearing.							
	6203-2RS	3/4"	1-9/16"	15/32"	45-005	6535	230-052	\$2.50

**Scag**

	Bearing No.	ID	OD	Height	Oregon	Rotary	Stens	Price
	<b>B1SB1265</b> 48224 - Ball Bearing. Fits on Turf Tiger models.							
	99502H-RST	5/8"	1-3/8"	7/16"	45-202	1265	230-019	\$4.00

	<b>B1SB483</b> 48102 - Ball Bearing. Fits idler pulleys on STHM and Tiger Club.							
	6203-2RS	5/8"	1-9/16"	15/32"	45-203	483	230-011	\$2.50

	<b>B1SC79</b> 481846 - Roller Bearing. Fits our B1WL55 wheel assembly.							
	--	21/32"	1-1/4"	15/16"	--	9463	--	\$4.20

	<b>B1AC229</b> 483446 - Ball Bearing. Fits caster spacer on Freedom Z.							
	6205-2RS	31/32"	2-1/32"	19/32"	45-227	7162	230-102	\$3.80

	<b>B1SC30</b> 48101, 48101-02 - Ball Bearing. Fits our B1CO73 spindle assembly. Sealed once side.							
	6305-Z	63/64"	2-7/16"	21/32"	--	7178	--	\$17.00

	<b>B1SB814</b> 48005-04, 48005-05, 481895, 481896, 48668 - Roller Bearing. Fits new style spindles. Includes race.							
	L44643/10	1"	1.98"	.56"	45-002	814	215-285	\$5.40

	<b>B1SB6534</b> 481858, 48193-01 - Ball Bearing. Fits spindle assemblies.							
	--	1"	2"	9/16"	45-031	6534	230-237	\$12.20

	<b>B1CO17</b> 48101-01, 48101-02 - Ball Bearing. Fits spindle assemblies.							
	6305-2RS	1"	2-7/16"	21/32"	45-401	3217	230-086	\$5.70





**Simplicity**

	Bearing No.	ID	OD	Height	Oregon	Rotary	Stens	Price
	<b>B1SB1265</b> 1665521 - Ball Bearing. Fits spindle assemblies.							
	99502H-RST	5/8"	1-3/8"	7/16"	45-202	1265	230-019	\$4.00

## Simplicity

	Bearing No.	ID	OD	Height	Oregon	Rotary	Stens	Price	
	<b>B1SB483</b> <b>1666292, 1705897</b> - Ball Bearing. Fits Consumer Z spindle assemblies.	6203-2RS	5/8"	1-9/16"	15/32"	45-203	483	230-011	\$2.50
	<b>B1AC61</b> <b>1666292, 1705897</b> - Ball Bearing. Fits Consumer Z spindle assemblies.	6203-ZZ	21/32"	1-9/16"	15/32"	45-624	7917	230-060	\$2.30
	<b>B1RS46</b> <b>1666292, 1705897</b> - Ball Bearing. Fits Consumer Z spindle assemblies.	6203-2RS	21/32"	1-9/16"	15/32"	45-257	8507	230-060	\$2.50
	<b>B1SB484</b> <b>108202, 2108202</b> - Ball Bearing. Fits Consumer Z spindle assemblies.	Z9504-RST	3/4"	1-25/32"	19/32"	45-402	484	230-160	\$3.60
	<b>B1SB813</b> <b>154393, 154486, 2154393, 2154486</b> - Roller Bearing. Includes race.	LM11949/10	3/4"	1.781"	.61"	45-206	813	230-929	\$4.90
	<b>B1SB442</b> <b>118011, 2118011</b> - Ball Bearing. Fits spindle assemblies.	6204-2RS	25/32"	1-27/32"	9/16"	45-403	442	230-029	\$3.00
	<b>B1SB814</b> <b>170835, 2170835</b> - Roller Bearing. Includes Race.	L44643/10	1"	1.98"	.56"	45-002	814	215-285	\$5.40

## Snapper

	Bearing No.	ID	OD	Height	Oregon	Rotary	Stens	Price	
	<b>B1SB3229</b> <b>1-2304, 2-8014, 7012304, 7028014</b> - Ball Bearing. Hex shaft bearing for 21" self-propelled mowers.	--	3/8"	1"	5/16"	45-209	3229	230-106	\$6.20
	<b>B1SB3228</b> <b>1-8767, 46983, 7046983</b> - Ball Bearing. Fits wheel arm assemblies on all self-propelled models. Includes clip.	1622-ZZ	9/16"	1-3/8"	7/16"	45-208	3228	230-144	\$3.70
	<b>B1SB481</b> <b>1-0756, 7010756</b> - Ball Bearing. Precision high-speed bearing. Double sealed. Packaged in lots of 10. Includes clip.	499502H-NR	5/8"	1-3/8"	7/16"	45-202	481	215-202	\$3.40
	<b>B1SB1265</b> <b>1-4514, 7-7324, 7014514</b> - Ball Bearing. Fits models with variable speed transmission. Fits our B1CO100 gearbox.	99502H-RST	5/8"	1-3/8"	7/16"	45-202	1265	230-019	\$4.00





Bearings

Snapper



	Bearing No.	ID	OD	Height	Oregon	Rotary	Stens	Price
	<b>B1SB483</b> <b>1-3020, 7013020</b> - Ball Bearing.							
	6203-2RS	5/8"	1-9/16"	15/32"	45-203	483	230-011	\$2.50
	<b>B1CO49</b> <b>7-6504, 7076504</b> - Ball Bearing. Output shaft support bracket bearing for 32", 36", and 48" decks.							
	SB202-10	5/8"	1-9/16"	7/8"	48-211	8077	230-056	\$7.30
	<b>B1AC61</b> <b>1-3020, 7013020</b> - Ball Bearing.							
	6203-ZZ	21/32"	1-9/16"	15/32"	45-624	7917	230-060	\$2.30
	<b>B1RS46</b> <b>1-3020, 7013020</b> - Ball Bearing.							
	6203-2RS	21-32"	1-9/16"	15/32"	45-257	8507	230-060	\$2.50
	<b>B1SB484</b> <b>1-0696, 1-3313, 5-4073, 7013313</b> - Ball Bearing.							
	Z9504-RST	3/4"	1-25/32"	19/32"	45-402	484	230-160	\$3.60
	<b>B1SN27</b> <b>1-4625, 70146245</b> - Bearing Collar. Includes set screw. Fits 25", 26", 28", 30", and 33" cut rear engine riders.							
	--	3/4"	1-5/16"	17/32"	--	8726	--	\$4.70
	<b>B1SB327</b> <b>1-1807, 7011807</b> - Ball bearing. Flanged. Package quantity: 5.							
	--	3/4"	1-3/8"	1/2"	45-234	327	215-046	\$2.10
	<b>B1SB328</b> <b>1-0953, 1-2390, 1-5474, 2-6693, 7026693, 7028722</b> - Ball Bearing. Fits wheel assemblies on self-propelled units. Package quantity: 5.							
	--	3/4"	1-3/8"	1/2"	45-234	328	230-128	\$4.20
	<b>B1SB6573</b> <b>1-0953, 1-2390, 1-3680, 1-5474, 7015474, 7028722</b> - Ball Bearing. Flanged. Fits our B1SN00 drive disc assembly for self-propelled models.							
	PRF122214-2RS	3/4"	1-3/8"	1/2"	45-010	6573	--	\$8.30
	<b>B1SB6536</b> <b>1-4624, 7014624</b> - Ball Bearing. Fits rear axle. Small bearing, left-hand side for Snapper Extra Tough Rider.							
	--	3/4"	1-3/4"	1-7/16"	--	6536	--	\$18.90
	<b>B1SB813</b> <b>1-2931</b> - Roller Bearing. Includes race.							
	LM11949/10	3/4"	1.781"	.61"	45-206	813	230-929	\$4.90





## Snapper

	Bearing No.	ID	OD	Height	Oregon	Rotary	Stens	Price	
	<b>B1SB442</b> <b>1-8228, 7012828</b> - Ball Bearing. Fits spindle assemblies on 60370 and 80499 54" decks.	6204-2RS	25/32"	1-27/32"	9/16"	45-403	442	230-029	\$3.00
	<b>B1AC229</b> <b>1-9572, 4-6555, 7019572, 7046555, 7-9813</b> - Ball Bearing. Fits series ZTR series 4 and 5. Fits 42", 48", and 60" mid-mount ZTR series 2 and 4 models.	6205-2RS	31/32"	2-1/32"	19/32"	45-227	7162	230-102	\$3.80
	<b>B1SB6534</b> <b>1-9169, 7019169</b> - Ball Bearing. Flanged. Fits mid-size units.	--	1"	2"	9/16"	45-031	6534	230-237	\$12.20
	<b>B1CO17</b> <b>1-9125, 1-6510</b> - Ball Bearing. Fits Pro gear drive and hydro drive loop-handle series, Pro 8 gear-drive loop-handle series, and Pro gear-driven pistol-grip series.	6305-2RS	1"	2-7/16"	21/32"	45-401	3217	230-086	\$5.70
	<b>B1SB2703</b> <b>1-1125, 7011125</b> - Ball Bearing. Back to back bearing.	--	--	--	--	45-131	2703	--	\$3.50

## Tecumseh

	Bearing No.	ID	OD	Height	Oregon	Rotary	Stens	Price	
	<b>B1SB8656</b> <b>780086A</b> - Needle Bearing. Fits 700 series transmission input shaft for 800 and 900 series transaxles.	--	5/8"	13/16"	1/2"	--	8656	--	\$8.00
	<b>B1SB6535</b> <b>780-119</b> - Ball Bearing.	6203-2RS	3/4"	1-9/16"	15/32"	45-005	230-052	2.5	\$2.50











## Toro

	Bearing No.	ID	OD	Height	Oregon	Rotary	Stens	Price	
	<b>B1SB483</b> <b>112-0423, 38-7820</b> - Ball Bearing. Fits S-200, S-620, and CCR snow throwers.	6203-2RS	5/8"	1-9/16"	15/32"	45-203	483	230-011	\$2.50
	<b>B1SB7210</b> <b>10-9966</b> - Ball Bearing. Fits spindle assemblies on 42" and 48" decks. Sealed one side.	6203-2RS	21/32"	1-9/16"	15/32"	45-624	7210	--	\$2.50
	<b>B1AC61</b> <b>112-0423, 38-7820</b> - Ball Bearing. Fits shafts on S200 snow throwers.	6203-ZZ	21/32"	1-9/16"	15/32"	45-624	7917	230-060	\$2.30



Bearings

Toro

	Bearing No.	ID	OD	Height	Oregon	Rotary	Stens	Price	
	<b>B1RS46</b> <b>112-0423, 38-7820</b> - Ball Bearing. Fits shafts on S200 snow throwers.	6203-2RS	21/32"	1-9/16"	15/32"	45-257	8507	230-060	\$2.50
	<b>B1SB484</b> <b>106947, 109642, 25-1351, 31-0530</b> - Ball Bearing.	Z9504-RST	3/4"	1-25/32"	19/32"	45-402	484	230-160	\$3.60
	<b>B1SB327</b> <b>110513, 25-1210</b> - Ball Bearing. Flanged. Package quantity: 5.	--	3/4"	1-3/8"	1/2"	45-234	327	215-046	\$2.10
	<b>B1SB328</b> <b>110513, 25-1210</b> - Ball Bearing. Package quantity: 5.	--	3/4"	1-3/8"	1/2"	45-234	328	230-128	\$4.20
	<b>B1SB6573</b> <b>110513, 25-1210</b> - Ball Bearing. Flanged.	PRF122214-2RS	3/4"	1-3/8"	1/2"	45-010	6573	--	\$8.30
	<b>B1SB6535</b> <b>106084, 106085, 37-0200</b> - Ball Bearing. Fits spindle assemblies. Fits riding mulcher unit 57380 and 57385	6203-2RS	3/4"	1-9/16"	15/32"	45-005	6535	230-052	\$2.50
	<b>B1SB487</b> <b>257-207</b> - Ball Bearing. Sealed high-speed bearing.	SC0493LU	3/4"	1-3/4"	1/2"	45-035	487	230-045	\$17.00
	<b>B1SB813</b> <b>245-78, 254-79</b> - Roller Bearing. Fits Roughmaster, Greensmaster, Spartan, and Reelmaster. Includes LM11949/10	LM11949/10	3/4"	1.781"	.61"	45-206	813	230-929	\$4.90
	<b>B1SB442</b> <b>112-03777, 25-1297, 251-8</b> - Ball Bearing.	6204-RS	25/32"	1-27/32"	9/16"	45-403	442	230-029	\$3.00
	<b>B1AC229</b> <b>251-257</b> - Ball Bearing. Fits 1977 and older Groundsmasters.	6205-2RS	31/32"	2-1/32"	19/32"	45-227	7162	230-102	\$3.80
	<b>B1SB814</b> <b>254-72, 254-94</b> - Roller bearing. Fits Greensmaster 3, 300, 3000, and 3100; Reelmaster 223D and 5100D. Includes race.	L44643/10	1"	1.98"	.56"	45-002	814	215-285	\$5.40

## Toro

	Bearing No.	ID	OD	Height	Oregon	Rotary	Stens	Price
	<b>B1SB6534</b> 251-299 - Ball Bearing. Flanged. Fits mid-size units.							
	--	1"	2"	9/16"	45-031	6534	230-237	\$12.20

## Troy Bilt



	Bearing No.	ID	OD	Height	Oregon	Rotary	Stens	Price
	<b>B1SB481</b> 7010756, 1185169, 1185436, 1701132, 1820278, 941-0155, GW1185169, GW-1793 - Ball Bearing. Precision high-speed bearing. Double sealed. Packaged in lots of 10. Includes clip.							
	499502H-NR	5/8"	1-3/8"	7/16"	45-202	481	215-202	\$3.40
	<b>B1SB1265</b> 1185169, 941-0155 - Ball Bearing.							
	99502H-RST	5/8"	1-3/8"	7/16"	45-202	1265	230-019	\$4.00
	<b>B1SB483</b> 112502, 1185064, 941-0124 - Ball Bearing.							
	6203-2RS	5/8"	1-9/16"	15/32"	45-203	483	230-011	\$2.50
	<b>B1AC61</b> 1120502, 1185064, 941-0124 - Ball Bearing. Fits S-200, S-620, and CCR snow throwers.							
	6203-ZZ	21/32"	1-9/16"	15/32"	45-624	7917	230-060	\$2.30
	<b>B1RS46</b> 1120502, 1185064, 941-0124 - Ball Bearing. Fits S-200, S-620, and CCR snow throwers.							
	6203-2RS	21/32"	1-9/16"	15/32"	45-257	8507	230-060	\$2.50
	<b>B1SB484</b> 1185574, 1185574P, 1185828 - Ball Bearing.							
	Z9504-RST	3/4"	1-25/32"	19/32"	45-402	484	230-160	\$3.60
	<b>B1SB813</b> 1185275, 1714, 941-0107 - Roller Bearing. Includes race.							
	LM11949/10	3/4"	1.781"	.61"	45-206	813	230-929	\$4.90
	<b>B1SB442</b> 1182151, 1728255 - Ball Bearing							
	6204-2RS	25/32"	1-27/32"	9/16"	45-403	442	230-029	\$3.00

## Walker



	Bearing No.	ID	OD	Height	Oregon	Rotary	Stens	Price
	<b>B1SB1265</b> 5037-1 - Ball Bearing. Fits wheel assemblies on MB and MC models.							
	99502H-RST	5/8"	1-3/8"	7/16"	45-202	1265	230-019	\$4.00

Bearings





Walker

	Bearing No.	ID	OD	Height	Oregon	Rotary	Stens	Price
	<b>B1CO7950</b> 5037-1 - Ball Bearing. Flanged. Fits wheel assemblies on MB and MC models.							
	--	5/8"	1-3/8"	1/2"	45-258	7950	215-370	\$9.70
	<b>B1SB484</b> 5265 - Ball Bearing. Fits idler pulley on MC and MT models.							
	Z9504-RST	3/4"	1-25/32"	19/32"	45-402	484	230-160	\$3.60
	<b>B1IH94</b> 5270 - Ball Bearing. Fits caster yokes and wheel assemblies on MB, MBS, MC, MD, and MT models. Includes collar.							
	CSA20516	1"	2-3/64"	27/32"	45-225	8488	225-217	\$8.40

Wheel Horse

	Bearing No.	ID	OD	Height	Oregon	Rotary	Stens	Price
	<b>B1WH19</b> 103119 - Ball Bearing. Fits spindle assemblies. Shaft OD: 0.75", L: 4.5"							
	--	3/4"	1-1/2"	2"	--	3309	230-078	\$31.00
	<b>B1AC229</b> 11-3514 - Ball Bearing. Fits 50" and 60" cut ZTR 500 series mowers. Sealed one side.							
	6205-2RS	31/32"	2-1/32"	19/32"	45-227	7162	230-102	\$3.80



Woods

	Bearing No.	ID	OD	Height	Oregon	Rotary	Stens	Price
	<b>B1MT61</b> 05408000 - Ball Bearing.							
	1621-2RS	1/2"	1-3/8"	7/16"	--	8869	230-276	\$3.80
	<b>B1CO7950</b> 70043 - Ball Bearing. Flanged.							
	--	5/8"	1-3/8"	1/2"	45-258	7950	215-370	\$9.70
	<b>B1SB484</b> 05412000, 16106 - Ball Bearing.							
	Z9504-RST	3/4"	1-25/32"	19/32"	45-402	484	230-160	\$3.60
	<b>B1SB814</b> 003585 - Roller Bearing. Includes race.							
	L44643/10	1"	1.98"	.56"	45-002	814	215-285	\$5.40
	<b>B1IH94</b> 60006, 70006 - Ball Bearing. Includes collar.							
	CSA20516	1"	2-3/64"	27/32"	45-225	8488	225-217	\$8.40



## Woods

	Bearing No.	ID	OD	Height	Oregon	Rotary	Stens	Price
	<b>B1GH50</b> <b>70345</b> - Ball Bearing. Pillow block bearing for 6180, 6182, 6200, 6215, 6250 and other models. Includes grease fitting.							
	UC205-16	1"	5-1/2"	2-3/4"	--	9160	230-437	\$12.00





## Wright

	Bearing No.	ID	OD	Height	Oregon	Rotary	Stens	Price
	<b>B1SB814</b> <b>77460002, 77460003</b> - Roller Bearing. Fits caster yokes on Sentar, Stander, and Z. Includes race.							
	L44643/10	1"	1.98"	.56"	45-002	814	215-285	\$5.40
	<b>B1CO17</b> <b>17146017, 71460017</b> - Ball Bearing. Fits spindle assemblies on Sentar, Sport, Stander, and Z.							
	6305-2RS	1"	2-7/16"	21/32"	45-401	3217	230-086	\$5.70

## Yazoo





	Bearing No.	ID	OD	Height	Oregon	Rotary	Stens	Price
	<b>B1SB1265</b> <b>204-020</b> - Ball Bearing. Fits YR60 and YR76							
	99502H-RST	5/8"	1-3/8"	7/16"	45-202	1265	230-019	\$4.00
	<b>B1SB483</b> <b>204-019</b> - Ball Bearing.							
	6203-2RS	5/8"	1-9/16"	15/32"	45-203	483	230-011	\$2.50
	<b>B1SB484</b> <b>204-060</b> - Ball Bearing.							
	Z9504-RST	3/4"	1-25/32"	19/32"	45-402	484	230-160	\$3.60

## Universal



	Bearing No.	ID	OD	Height	Oregon	Rotary	Stens	Price
	<b>B1AC63</b> Ball Bearing. For Go-Karts with free-spinning bore for live axles.							
	UC206-20K	1-1/4"	2-31/64"	1-1/2"	--	--	--	\$18.50
	<b>B1SB9892</b> Ball Bearing. Flanged. Fits many universal wheels.							
	--	3/8"	1-1/8"	.375"	--	9892	--	\$1.50
	<b>B1SB1266</b> Ball Bearing.							
	6200-2RS	10 mm	30 mm	9 mm	45-620	1266	--	\$3.50
	<b>B1SB325</b> Ball Bearing. Flanged. Fits many universal wheels. Package quantity: 5.							
	--	1/2"	1-3/8"	7/16"	45-012	325	215-020	\$0.90

Bearings

Universal

	Bearing No.	ID	OD	Height	Oregon	Rotary	Stens	Price
	<b>B1SB1264</b> Ball Bearing.							
	1622-2RS	9/16"	1-3/8"	7/16"	45-162	1264	--	\$3.80
	<b>B1SB7312</b> Ball Bearing. Fits Echo, Red Max, Green Machine, Shindaiwa, Kawasaki chain saws, trimmers and blowers. Open both sides.							
	6202 Open	37/64"	1-3/8"	7/16"	45-162	7312	--	\$2.80
	<b>B1SB2945</b> Ball Bearing.							
	1623-2RS	5/8"	1-3/8"	7/16"	45-202	--	--	\$3.80
	<b>B1AC64</b> Ball Bearing. For Go-Kart rear axles. Includes collar.							
	SA205-16	1"	2-3/64"	27/32"	--	--	--	\$8.50

**Bobcat**

	ID	OD	Width	Oregon	Rotary	Stens	Price
	<b>B1SB5812</b>	<b>38273, 38274</b> - Open cage roller bearing with flanged bushings for our B1CO84 and B1SB8098 wheel assemblies					
	5/8"	1-3/8"	3-15/16"	45-121	5812	230-665	\$8.20
	<b>B1SB5848</b>	<b>38042N, 38069N</b> - Contains open cage roller bearing with flanged bushings. Fits our B1C055 Deck wheel for 32", 36" and 48" mid-size mowers.					
	5/8"	1-13/32"	2-7/32"	45-196	5848	--	\$6.50

**Dixie Chopper**

	ID	OD	Width	Oregon	Rotary	Stens	Price
	<b>B1DC49</b>	<b>10205, 67204, 67205</b> - Fits our B13005 wheel assembly. Includes our B1CO7950 bearings, B1SB1265 bearings and B1DC72 spanner bushing. Fits Dixie wheel assemblies 10202 and 97166.					
	5/8"	1-3/8"	4"	--	9719	--	\$29.30



**Dixon**

	ID	OD	Width	Oregon	Rotary	Stens	Price
	<b>B1SB8433</b>	<b>5391168021, 8178, 8179</b> - Roller cage bearing with retainer bushings. Fits 42" and 50" cut Dixon ZTR with single arm caster wheel (Dixon #8178)					
	1"	1-3/8"	3-3/16"	--	8433	--	\$8.30

**Encore**

	ID	OD	Width	Oregon	Rotary	Stens	Price
	<b>B1SB8408</b>	<b>363012</b> - Includes roller cage bearing and two retainer bushings.					
	49/64"	1-1/4"	4-15/32"	45-060	8408	230-669	\$16.70

**Exmark**



	ID	OD	Width	Oregon	Rotary	Stens	Price
	<b>B1EM150</b>	<b>1-633580, 1-633581, 1-633585, 103-0063</b> - Fits Lazer Z units. Kit includes (2) B1SB813 bearings, (2) B1EM27 seals, and (2) B1EM25 spacers. Used in our B1WL35, B1WK36, B1WL37, B1FP105 and B1FP109 wheel assemblies.					
	3/4"	1-25/32"	--	--	9944	230-705	\$18.80
	<b>B1SB8408</b>	<b>1-513809, 1-513810</b> - Includes roller cage bearing and two retainer bushings.					
	49/64"	1-1/4"	4-15/32"	45-060	8408	230-669	\$14.60

Bearing Kits

**Gravelly**

	ID	OD	Width	Oregon	Rotary	Stens	Price
	<b>B1SB8439</b> <b>20637700</b> - Fits our B1CO106, B1CO8550, and B1CO8579 front caster wheel assemblies Fits Gravelly 45205.						
	1/2"	1-3/8"	3-21/64"	--	8439	--	\$16.70

**John Deere**

	<b>B1JD57</b> Fits our B1WL55, B1WL58, B1FP106, B1FP123. Contains (2) B1JD63 bushings, (1) B1JD62 cage bearing, and (1) B1JD61 cage bearing.						
	--	--	--	--	--	--	\$12.90
	<b>B1JD7952</b> <b>TCA12476, TCA12493</b> - Fits our B1FP102 and B1FP112 Flatproof wheel assemblies. Contains (2) B1JD7950 bushings and (1) B1JD7951 cage bearing.						
	3/4"	1-3/8"	--	--	--	--	\$9.30



**Scag**

	<b>B1SB5812</b> <b>48006-06, 48006-07, 481769, 481770</b> - Fits our B1CO8580 wheel assembly.						
	5/8"	1-3/8"	3-15/16"	45-121	5812	230-665	\$8.20

**Snapper**



	<b>B1SB5812</b> <b>22394, 22395, 7022394, 7022395</b> - Contains (1) open cage roller bearing and (2) flanged bushings.						
	5/8"	1-3/8"	3-15/16"	45-121	5812	230-665	\$8.20

**Toro**

	<b>B1TO8440</b> <b>62-5570, 62-5580</b> - Fits our B1CO8684 and B1CO8866 caster wheel assemblies. Also fits Toro mid-sized mower 36", 37", 44", 52" and 62" cut deck, models 30136, 30137, 30144, 30152, 30162. Kit contains cage roller bearing and retainer bushings only.						
	3/4"	1-1/4"	2-15/16"	--	8440	--	\$8.20
	<b>B1TO8441</b> <b>62-5570, 62-5580</b> - Fits our B1CO8684 and B1CO8866 caster wheel assemblies. Also fits Toro mid-sized mower 36", 37", 44", 52" and 62" cut deck, models 30136, 30137, 30144, 30152, 30162. Kit contains our B1TO8440 bearing kit and spanner bushing.						
	1/2"	1-3/8"	3-11/32"	--	8441	--	\$12.50



**Velke**

	ID	OD	Width	Oregon	Rotary	Stens	Price	
	<b>B1SB9276</b> <b>VKXGBRGKIT</b> - Fits Velke 2 wheel sulkis. Kit contains a roller cage bearing, retainer bushings, and spanner bushing. Fits B1FP115.	1"	1-3/4"	2-1/4"	--	9276	--	\$23.40
	<b>B1SB8668</b> <b>VKBRKIT</b> - Fits Velke 2 wheel sulkies. Kit contains a roller cage bearing and retainer bushings. Does not include spanner.	25/32"	1-11/32"	3/8"	--	8668	--	\$8.30
	<b>B1SB8670</b> <b>VKBRGKIT</b> - Fits Velke 2 wheel sulkies. Kit contains a roller cage bearing and retainer bushings includes spanner.	25/32"	1-11/32"	3/8"	--	8670	--	\$10.90

**Walker**











	ID	OD	Width	Oregon	Rotary	Stens	Price	
	<b>B1CO8319</b> <b>5714-3, 5714-4, 5714-7</b> - Fits front wheel on 36", 42", 48", 54" ZTR machines. Kit contains a roller cage bearing, retainer bushings and a spanner bushing. Fits our B1CO7982 wheel assembly.	3/8"	1-3/8"	3-9/16"	--	8319	--	\$16.70

**Wright**

	ID	OD	Width	Oregon	Rotary	Stens	Price	
	<b>B1EM150</b> <b>98460019</b> - Fits Sentar, Sport, Stander, and Z models. Kit contains (2) B1SB813 bearings, (2) B1EM27 seals, and (2) B1EM25 spacers. Used in our B1WL35, B1WL36, B1WL37 B1FP105 and B1FP109 wheel assemblies.	3/4"	1-25/32"	--	--	9944	230-705	\$18.40



Bushings and Spacers

	ID	OD	Height	Flange ID	Material	Oregon	Rotary	Stens	Price
<b>Ariens</b>									
	<b>B1SB3222</b> <b>01137000</b> Flanged Bushing. Graphite impregnated.								
	3/4"	1"	1-15/16"	1-1/8"	--	45-094	3222	--	\$4.20
	<b>B1SB2935</b> <b>05502800</b> Flanged Bushing. Grafoil type wheel bushing. Fits 12970-12995 with spec. #000001 Fairway.								
	3/4"	1-1/8"	3/4"	1-1/4"	--	45-084	2935	225-078	\$1.60
	<b>B1SB8796</b> <b>05503000</b> Bushing. Axle bushing for snow thrower models 824, 910, and 924.								
	7/8"	1"	5/8"	1-1/4"	--	45-013	8796	225-862	\$1.90
	<b>B1SB8446</b> <b>05503500</b> Flanged Bushing. Auger side bushing for all snow thrower models 1960 to present. Oil impregnated								
	1"	1-1/8"	5/8"	--	Bronze	45-006	8446	225-839	\$2.90
	<b>B1AC226</b> <b>05503900</b> Flanged Bushing. Fits 832 and 1032 snow thrower attachment scoops.								
	3/4"	1"	5/8"	--	--	45-007	8445	225-854	\$3.10
	<b>B1SB3305</b> <b>05505800</b> Flanged Bushing. Graphite impregnated.								
	3/4"	1-3/8"	3/4"	1-9/16"	--	45-098	3305	215-565	\$3.80
	<b>B1SB8783</b> <b>05521300, 05521600</b> Bushing. Hex-shaped bushing for newer snow thrower models ST-524 and ST-724. Oil Impregnated.								
	3/4"	7/8"	21/32"	1-3/16"	Iron	--	8783	225-763	\$2.00
<b>AYP</b>									
	<b>B1RS10</b> <b>102792X, 120382X, 120754X, 123848X, 126847X</b> Bushing. Drag link bushing for front engine riders. Packaged in quantities of four.								
	3/8"	17/32"	15/32"	11/16"	--	45-128	7279	--	\$1.40
	<b>B1RS29</b> <b>121922X</b> Bushing. Front axle bushing for models 3363 (1999 and older), 3364 (1991), 9120A29 (1992), CC1236A, CT1036A, CT1236A/B (1991).								
	3/4"	53/64"	25/32"	1-1/8"	Plastic	--	9745	225-600	\$2.30
	<b>B1EP150</b> <b>174284</b> Bushing. Roller cam assembly for 42" deck.								
	.250"	.575"	.375"	--	--	--	9747	--	\$5.50
	<b>B1SB2935</b> <b>3736R</b> Flanged Bushing. Grafoil type wheel bushing.								
	3/4"	1-1/8"	3/4"	1-1/4"	--	45-084	2935	225-078	\$1.60







	ID	OD	Height	Flange ID	Material	Oregon	Rotary	Stens	Price
<b>AYP</b>									
	<b>B1SB339</b> <b>625J</b> Flanged Bushing. Graphite impregnated wheel bushing. Fits models BS1960AR, L1900BR, L1910AR, L1930BT, L1950BR, L1960AR and L1970AR, 1999 and older.								
	3/4"	1-3/8"	5/8"	1-1/2"	--	45-079	339	215-145	\$2.60
	<b>B1SB2936</b> <b>64906</b> Bushing. Graphite impregnated wheel bushing. Flat on one side.								
	5/8"	1-1/8"	3/4"	1-1/4"	--	45-087	2936	225-086	\$2.10
	<b>B1SB7258</b> <b>9040H</b> Flanged Bushing. Wheel bushing for models 6A1A1E, 6C1A7E, 6H1A9D, AK12542C and AK125HR38A.								
	3/4"	1-3/8"	1"	--	Plastic	45-043	7258	225-029	\$1.70
<b>Bobcat</b>									
	<b>B1CO26</b> <b>48053-2A</b> Flanged Bushing. Support arm bushing.								
	1"	1-1/4"	3/4"	1-5/8"	--	48-320	5707	225-714	\$4.20
	<b>B1CO8240</b> <b>48053-2A</b> Flanged Bushing. Caster bushing for 8" wheel support. Fits mid-size hydro and belt-driven mowers.								
	1"	1-1/4"	1"	1-3/4"	--	48-320	8240	225-714	\$2.20
<b>Bunton</b>									
	<b>B1CO26</b> <b>PJH1060</b> Flanged Bushing. Support arm bushing.								
	1"	1-1/4"	3/4"	1-5/8"	--	48-320	5707	225-714	\$4.20
	<b>B1CO8240</b> <b>PJH1060</b> Flanged Bushing. Caster bushing for 8" wheel support. Fits mid-size hydro and belt-driven mowers.								
	1"	1-1/4"	1"	1-3/4"	--	48-320	8240	225-714	\$2.20
	<b>B1CO32</b> <b>PL0928</b> Bushing. Caster bushing. Fits support arm.								
	7/8"	1-1/8"	1-1/4"	--	--	45-029	5703	--	\$4.00
	<b>B1SB8412</b> <b>Z35010</b> Spacer. Wheel spacer for 36", 48", 52", and 61" cut mid-size front-cut riders. Order in multiples of 10.								
	3/4"	1-1/4"	3/32"	--	--	--	8412	--	\$0.60
<b>Dixie Chopper</b>									
	<b>B1DC73</b> <b>10203</b> Bushing. Spanner bushing. Fits our B13005 wheel assembly.								
	5/8"	7/8"	1"	--	--	--	9606	--	\$3.20

Bushings and Spacers











	ID	OD	Height	Flange ID	Material	Oregon	Rotary	Stens	Price
<b>Dixie Chopper</b>									
	<b>B1DC29</b> 30219 Spacer. Spindle bearing spacer.								
	1"	1-1/4"	2-3/4"	--	--	--	10081	--	\$8.00
	<b>B1DC72</b> 67204 Spacer. Inner wheel spacer. Fits our B13005 wheel assembly.								
	5/8"	7/8"	2"	--	--	--	9709	--	\$3.00
<b>Encore</b>									
	<b>B1CO34</b> 363007 Flanged Bushing. Caster yoke support arm bushing. Fits Premier HydroPro, Premier Pro and Prowler Midcut.								
	7/8"	1-1/8"	1"	1-1/2"	--	45-127	5713	225-722	\$3.30
<b>Exmark</b>									
	<b>B1EM20</b> Spacer. Wheel spacer for 13 x 650 x 6 caster wheels on Lazer Z.								
	1/2"	3/4"	7-1/2"	--	--	--	9992	--	\$7.60
	<b>B1CO32</b> 1-303041 Bushing. Caster Bushing. Fits support arm.								
	7/8"	1-1/8"	1-1/4"	--	--	45-029	5703	--	\$4.00
	<b>B1CO34</b> 1-303044, 1-303514 Flanged Bushing. Caster yoke support arm bushing.								
	7/8"	1-1/8"	1"	1-1/2"	--	45-127	5713	225-722	\$3.30
	<b>B1SB8409</b> 1-513547 Bushing. Spanner bushing used with our B1SB8408 bearing kit.								
	1/2"	3/4"	4-5/8"	--	--	48-011	8409	--	\$4.50
	<b>B1EM26</b> 1-543511 Seal. Front caster yoke bearing seal.								
	1-1/4"	2"	1/4"	--	--	--	10014	--	\$3.30
	<b>B1EM22</b> 1-603602 Bushing. Deck wheel bushing for our B1SB6917 deck wheel. For 52", 60" and 72" cut and Anti scalp rollers.								
	25/64"	5/8"	2-13/16"	--	--	48-007	8586	225-205	\$6.70
	<b>B1EM27</b> 1-633580, 103-0063 Seal. Front seal wheel bearing. Fits Lazer Z units. Used in our B1EM150 bearing kit.								
	1-1/8"	1-3/4"	7/16"	--	--	--	10013	285-787	\$2.90
	<b>B1EM25</b> 1-633581 Spacer. Wheel spacer. Fits Lazer Z. Fits our B1WL35, B1WL36, and B1FP109. Used in our B1EM150 bearing kit.								
	3/4"	1-1/8"	5/8"	--	--	--	10064	230-225	\$1.50

	ID	OD	Height	Flange ID	Material	Oregon	Rotary	Stens	Price
<b>Ferris</b>									
	<b>B1CO26</b> <b>1520822</b> Flanged Bushing. Support arm bushing.								
	1"	1-1/4"	3/4"	1-5/8"	--	48-320	5707	225-714	\$4.20
	<b>B1CO8240</b> <b>1520822</b> Flanged Bushing. Caster bushing. Fits mid-size hydro and belt-driven mowers.								
	1"	1-1/4"	1"	1-3/4"	--	48-320	8240	225-714	\$2.20
<b>Gilson</b>									
	<b>B1SB2935</b> <b>24829</b> Flanged Bushing. Grafoil type wheel bushing.								
	3/4"	1-1/8"	3/4"	1-1/4"	--	45-084	2935	225-078	\$1.60
<b>Gravelly</b>									
	<b>B1CO8485</b> <b>011387</b> Bushing. Wheel bushing. Fits 40" commercial center mount mower models. Use with our B1SB5915 wheel assembly.								
	1/2"	3/4"	2-5/8"	--	--	--	8485	--	\$6.50
	<b>B1SB8420</b> <b>011950</b> Bushing. Spanner bushing only. Used in our B1SB8439.								
	1/2"	3/4"	3-11/32"	--	--	--	8420	225-367	\$3.80
	<b>B1GR25</b> <b>018355</b> Bushing. Yoke bushing. Fits Models Promaster, Pro 40, Pro 50, Pro 100, and Pro 200. Minimum order of ten.								
	1"	1-3/8"	3/4"	1-3/4"	Nylon	--	8522	225-726	\$1.60
	<b>B1SB8738</b> <b>05521600</b> Bushing. Hex-shaped bushing for 815006-000101, 834034-000101, 836011-000101, 834035-000101, 987103 (GLT584H) and 987107 (GLT584H)								
	3/4"	7/8"	21/32"	1-3/16"	Iron	--	8783	225-763	\$2.00
	<b>B1SB8738</b> <b>092061</b> Bushing. Spanner bushing for caster wheels on Promaster 200 with 50" and 60" decks.								
	17/32"	3/4"	6-1/4"	--	--	--	8738	--	\$8.40
<b>Honda</b>									
	<b>B1SB8412</b> <b>4033106, 4034054, 4034062, 4034112</b> Spacer. Wheel spacer for HRC 7013 36" and 48" mid-size mowers.								
	3/4"	1-1/4"	3/32"	--	--	--	8412	--	\$0.60
<b>Husqvarna</b>									
	<b>B1RS10</b> <b>532 12 07-54</b> Bushing. Drag link bushing for front engine riders. Packaged in quantities of four.								
	3/8"	17/32"	15/32"	11/16"	--	45-128	7279	--	\$1.40



Bushings and Spacers

	ID	OD	Height	Flange ID	Material	Oregon	Rotary	Stens	Price
<b>Husqvarna</b>									
	<b>B1CO34</b> <b>539 10 12-32</b> Flanged Bushing. Caster yoke support arm bushing.								
	7/8"	1-1/8"	1"	1-1/2"	--	45-127	5713	225-722	\$3.20
<b>Jacobsen</b>									
	<b>B1SB8783</b> <b>53836</b> Bushing. Hex-shaped bushing for newer snow thrower models. Oil impregnated.								
	3/4"	7/8"	21/32"	1-3/16"	Iron	--	8783	225-763	\$2.00
<b>John Deere</b>									
	<b>B1JD63</b> Flanged Bushing. Oilite bushing for our B1JD57.								
	.650/.658"	1.407"	.625"	--	--	--	--	--	\$3.40
	<b>B1CO8240</b> <b>AM83541</b> Flanged Bushing. Caster bushing. Fits 160, 172, and 261 rotary mowers and 54"-72" mid-mount mowers.								
	1"	1-1/4"	1"	1-3/4"	--	48-320	8240	225-714	\$2.20
	<b>B1SB2935</b> <b>C16522, CH18688, E16522, M41522</b> Flanged Bushing. Grafoil type wheel bushing.								
	3/4"	1-1/8"	3/4"	1-1/4"	--	45-084	2935	225-078	\$1.60
	<b>B1SB8446</b> <b>M124417</b> Flanged Bushing. Fits 828D, 924DE, 1032D, 1128DDE, 1128DE, and 1332DDE walk-behind snow throwers. Oil impregnated.								
	1"	1-1/8"	5/8"	--	Bronze	45-006	8446	225-839	\$2.90
	<b>B1AC226</b> <b>M127082</b> Flanged Bushing. Fits 524D, 724D, and 826D walk-behind snow throwers.								
	3/4"	1"	5/8"	--	--	45-007	8445	225-854	\$3.10
	<b>B1SB8783</b> <b>M127093</b> Bushing. Hex-shaped bushing for newer snow thrower models. Oil impregnated.								
	3/4"	7/8"	21/32"	1-3/16"	Iron	--	8783	225-763	\$2.00
	<b>B1CO26</b> <b>M83541</b> Flanged Bushing. Support arm bushing.								
	1"	1-1/4"	3/4"	1-5/8"	--	48-320	5707	225-714	\$4.20
	<b>B1SB8707</b> <b>M84516</b> Bushing. Spanner bushing for our B1SB8551 11x4.00x5 caster wheel assembly.								
	1/2"	3/4"	5-9/16"	--	--	--	8707	--	\$8.20
	<b>B1SB8706</b> <b>M91080</b> Bushing. Spanner bushing for our B1CO8550 9x3.50x4 caster wheel assembly.								
	1/2"	3/4"	4-9/16"	--	--	--	8706	--	\$7.40













	ID	OD	Height	Flange ID	Material	Oregon	Rotary	Stens	Price
<b>Husqvarna</b>									
	<b>BIJD7950</b> <b>TCA12476</b> Flanged Bushing. Bushing for Flatproof tire B1FP102 and B1FP112.								
	3/4"	1-3/8"	0.625"	--	--	--	--	--	\$2.00
<b>K&amp;S</b>									
	<b>B1SB3216</b> <b>3999, T16276</b> Flanged Bushing. Fits Air Cap/K&S edgers.								
	1/2"	3/4"	3/4"	15/16"	Bronze	45-019	3216	225-276	\$1.90
	<b>B1SB8654</b> <b>T16276</b> Flanged Bushing. Edger shaft bushing.								
	1/2"	3/4"	1"	15/16"	--	--	8654	225-276	\$2.00
<b>Keese</b>									
	<b>B1CO34</b> <b>101232, 363194, 976514</b> Flanged Bushing. Caster yoke support arm bushing. Fits 10" support arm.								
	7/8"	1-1/8"	1"	1-1/2"	--	45-127	5713	225-722	\$3.20
<b>Lawn Boy</b>									
	<b>B1SB2935</b> <b>100166, 704497</b> Flanged Bushing. Grafoil type wheel bushing.								
	3/4"	1-1/8"	3/4"	1-1/4"	--	45-084	2935	225-078	\$1.60
	<b>B1SB6542</b> <b>681604</b> Sleeve and Bushing Assembly. Fits drive shaft on self-propelled mowers. Includes sleeve. Order in multiples of two.								
	1/2"	7/8"	29/32"	--	--	45-099	6542	--	\$5.60
<b>Lesco</b>									
	<b>B1CO26</b> <b>050295</b> Flanged Bushing. Support arm bushing.								
	1"	1-1/4"	3/4"	1-5/8"	--	48-320	5707	225-714	\$4.20
	<b>B1CO8240</b> <b>050295</b> Flanged Bushing. Caster bushing. Fits mid-size hydro and belt-driven mowers.								
	1"	1-1/4"	1"	1-3/4"	--	48-320	8240	225-714	\$2.20
	<b>B1CO34</b> <b>050339</b> Flanged Bushing. Caster yoke support arm bushing.								
	7/8"	1-1/8"	1"	1-1/2"	--	45-127	5713	225-722	\$3.20
<b>MTD</b>									
	<b>B1SB382</b> <b>741-0108, 941-0108</b> Flanged Bushing. Bronze bushing.								
	1/2"	3/4"	19/32"	1"	Bronze	45-085	382	--	\$1.80

Bushings and Spacers

	ID	OD	Height	Flange ID	Material	Oregon	Rotary	Stens	Price
<b>MTD</b>									
	<b>B1SB3200</b> <b>741-0199, 941-0199</b> Bushing. Wheel bushing. Fits 311-100A, 311-430A, 311-600A models and 450, 550, and 580 snow throwers.								
	3/4"	1-1/4"	3/4"	1-3/8"	Nylon	45-082	3200	225-235	\$2.00
	<b>B1MT11</b> <b>741-0225, 941-0225</b> Flanged Bushing. Hex kingpin bushing. Fits 38" and 42" cut front engine riders. Package quantity: 5.								
	5/8"	7/8"	5/8"	--	Plastic	45-100	7836	225-532	\$2.00
	<b>B1SB3211</b> <b>741-0293, 748-0143, 941-0293</b> Flanged Bushing. Fits 440, 450, 550, 552, 586, and 588 (1987-1988) series snow throwers and 300, 400, and 500 series lawn tractors.								
	3/4"	1"	3/4"	1-1/4"	Nylon	45-092	3211	225-114	\$2.80
	<b>B1MT18</b> <b>741-0313, 741-0487, 741-0487A, 741-0487C, 941-0487A</b> Flanged Bushing. Fits rider models 530-568 and 600-658. Package quantity: 10.								
	5/8"	13/16"	1-1/8"	--	Nylon	45-095	7720	225-750	\$1.90
	<b>B1MT46</b> <b>741-0340, 941-0340</b> Bushing. Bearing sleeve. Fits 600 series. Also fits 1985-197 MTD rider models 135-137 with single speed tansaxle only.								
	3/4"	1"	1"	--	--	--	9572	--	\$3.00
	<b>B1SB293</b> <b>748-0110, 948-0110</b> Flanged Bushing. Fits tillers.								
	5/8"	7/8"	5/8"	1-1/8"	Bronze	--	293	--	\$2.50
	<b>B1SB3222</b> <b>748-0169, 948-0169</b> Flanged Bushing. Graphite impregnated.								
	3/4"	1"	1-15/16"	1-1/8"	--	45-094	3222	--	\$4.20
	<b>B1SB3201</b> <b>748-0184</b> Flanged Bushing. Fits 440, 450, 550, 552, 586, 588, 840, 841, and 850 snow throwers and 375, 380, 405, and 410 tillers.								
	5/8"	3/4"	3/4"	1-1/8"	Bronze	45-089	3201	225-110	\$2.00
	<b>B1SB3202</b> <b>748-0227, 948-0227</b> Flanged Bushing. Six-sided lower wheel drive bearing for model 406 tiller. Fits tiller models 020 and 030 lower chain case. Also fits 603 edger.								
	5/8"	7/8"	1-11/16"	1-1/8"	Bronze	45-088	3202	225-128	\$3.00
	<b>B1SB3209</b> <b>748-0855</b> Flanged Bushing. Fits tillers.								
	5/8"	3/4"	1"	1-1/4"	--	45-091	3209	--	\$3.10
	<b>B1SB3213</b> <b>748-0867, 948-0867</b> Flanged Bushing. Fits all 700 series transmissions, 3 and 5 speed output shaft. Also fits 800 and 900 series transaxles. Oil impregnated.								
	5/8"	3/4"	3/4"	1"	Bronze	45-093	3213	--	\$3.20











	ID	OD	Height	Flange ID	Material	Oregon	Rotary	Stens	Price
<b>Murray</b>									
	<b>B1MU50</b> Spacer. Spacer used in our B1SB2925 spindle housing and B1MU54 housing repair kit. Package quantity: 5.								
	5/8"	7/8"	1-11/16"	--	--	--	2892	--	\$1.40
	<b>B1MU67</b> <b>23213, 23213Z, 24533</b> Spacer. Shaft spacer for center pulley on 42" decks.								
	5/8"	7/8"	11/16"	--	--	--	8308	--	\$3.00
	<b>B1SB7258</b> <b>24367, 481334, 491334MA, 91334</b> - Flanged Bushing. Wheel bushing. Used on 36", 38" and 40" front engine riders.								
	3/4"	1-3/8"	1"	--	Plastic	45-043	7258	225-029	\$1.70
	<b>B1SB2936</b> <b>24615</b> Flanged Bushing. Graphite impregnated wheel bushing. Flat on one side.								
	5/8"	1-1/8"	3/4"	1-1/4"	--	45-087	2936	225-086	\$2.10
	<b>B1SB2935</b> <b>403010, 403010MA</b> Flanged Bushing. Grafoil type wheel bushing.								
	3/4"	1-1/8"	3/4"	1-1/4"	--	45-084	2935	225-078	\$1.60
	<b>B1SB7716</b> <b>93064</b> Flanged Bushing. Front wheel bushing for 46371X92A and 18 HP lawn tractors.								
	7/8"	1-3/8"	29/32"	--	Plastic	45-023	7716	215-305	\$2.60
<b>Noma</b>									
	<b>B1SB339</b> <b>39979</b> Flanged Bushing. Graphite impregnated wheel bushing. Fits 3189-0300 and 5290-2100, 32" decks.								
	3/4"	1-3/8"	5/8"	1-1/2"	--	45-079	339	215-145	\$2.60
	<b>B1SB2935</b> <b>39980</b> Flanged Bushing. Grafoil type wheel bushing.								
	3/4"	1-1/8"	3/4"	1-1/4"	--	45-084	2935	225-078	\$1.60
	<b>B1SB3305</b> <b>40195</b> Flanged Bushing. Graphite impregnated.								
	3/4"	1-3/8"	3/4"	1-9/16"	--	45-098	3305	215-565	\$3.80
	<b>B1AM45</b> <b>52407</b> Flanged Bushing. Used on 39" cut, 12 HP front engine rider models 3912-081 and 3912-082.								
	3/4"	1"	3/4"	1-3/8"	--	--	8306	--	\$1.90
	<b>B1SB8783</b> <b>53836</b> Bushing. Hex-shaped bushing for newer snow thrower models. Oil impregnated.								
	3/4"	7/8"	21/32"	1-3/16"	Iron	--	8783	225-763	\$2.00

## Bushings and Spacers



	ID	OD	Height	Flange ID	Material	Oregon	Rotary	Stens	Price
<b>Noma</b>									
	<b>B1SB3303</b> 54902 Flanged Bushing. Graphite impregnated.								
	3/4"	1-3/8"	1/2"	1-9/16"	--	45-123	3303	--	\$2.80
<b>Scag</b>									
	<b>B1SB7262</b> 43022 Bushing. Wheel bushing. Used in our B1SB5812 bearing kit and B1CO8580 wheel assembly.								
	1/2"	5/8"	4-1/16"	--	--	45-188	7262	--	\$4.60
	<b>B1SC80</b> 43430 Bushing. Spanner bushing for Turf Tigers. Fits our B1WL55 wheel assembly.								
	1/2"	1"	6"	--	--	--	9613	--	\$5.60
	<b>B1EM25</b> 43584 Bushing. Caster wheel spacer for Sabre Tooth Tiger, Tiger Cub, Turf Tiger, and Wildcat.								
	3/4"	1-1/8"	5/8"	--	--	--	10064	230-225	\$1.50
	<b>B1CO34</b> 48100-01 Flanged Bushing. Caster yoke support arm bushing. Used on Scag 46082 support arm.								
	7/8"	1-1/8"	1"	1-1/2"	--	45-127	5713	225-722	\$3.20
<b>Simplicity</b>									
	<b>B1SB2935</b> 156316, 2156316 Flanged Bushing. Grafoil type wheel bushing. Fits 3100, 4200, 5200 and 6500 riders.								
	3/4"	1-1/8"	3/4"	1-1/4"	--	45-084	2935	225-078	\$1.60
<b>Snapper</b>									
	<b>B1SB2940</b> Bushings. Top steering bushing.								
	29/32"	31/32"	5/8"	1-1/4"	Nylon	--	2940	225-797	\$0.40
	<b>B1SB2939</b> 1-0694, 7010694 Bushing. Bottom steering bushing.								
	5/8"	11/16"	5/8"	1"	Nylon	45-101	2939	--	\$0.40
	<b>B1SB8493</b> 1-0935, 7010935 Spacer. Wheel spacer fits 25", 26", 28", 30", and 33" rear engine riders. Used in our B1SN8322 front end repair kit.								
	3/4"	1-1/8"	1/16"	--	--	--	8493	--	\$0.50
	<b>B1SB854</b> 1-0986, 7010986 Bushing. Kingpin bushing.								
	3/4"	13/16"	9/16"	1-1/4"	Nylon	45-081	854	--	\$0.40

	ID	OD	Height	Flange ID	Material	Oregon	Rotary	Stens	Price
<b>Snapper</b>									
	<b>B1SN61</b> <b>1-2296, 7012296</b> - Bushing. Rear axle bushing with grease fitting for 26"-33" rear-engine riders. Right side.								
	1-1/8"	1-5/8"	1-1/2"	1-3/4"	--	45-102	6864	--	\$2.80
	<b>B1SB2907</b> <b>1-2309, 7012309</b> Bushing. Wheel bushing for our B1SB2991, B1SB2992, and B1SB855.								
	7/16"	9/16"	1-5/8"	--	--	--	2907	--	\$0.90
	<b>B1SB853</b> <b>1-3321, 7013321</b> Bushing. Tie rod bushing.								
	3/8"	1/2"	3/8"	5/8"	Nylon	45-083	853	--	\$0.50
	<b>B1SB7262</b> <b>22151, 7022151</b> Bushing. Wheel bushing. Used in our bearing kit B1SB5812.								
	1/2"	5/8"	4-1/16"	--	--	45-188	7262	--	\$4.60
	<b>B1CO8240</b> <b>23556, 7023556</b> Flanged Bushing. Caster bushing. Fits mid-size hydro and belt-driven mowers.								
	1"	1-1/4"	1"	1-3/4"	--	48-320	8240	225-714	\$2.20
	<b>B1CO26</b> <b>2-3556, 7023556</b> Flanged Bushing. Support arm bushing.								
	1"	1-1/4"	3/4"	1-5/8"	--	48-320	5707	225-714	\$4.20
	<b>B1SN107</b> <b>5-0918, 7050918</b> Bushing. Rear axle bushing with grease fitting for 26"-33" rear-engine riders. Left side.								
	3/4"	1-5/8"	1-3/4"	1-3/4"	--	45-107	6863	225-987	\$8.90
	<b>B1CO34</b> <b>363194, 7-6514, 7076514</b> Flanged Bushing. Caster yoke support arm bushing. Fits variable speed walk-behind units.								
	7/8"	1-1/8"	1"	1-1/2"	--	45-127	5713	225-722	\$3.20
	<b>B1CO32</b> <b>7-6515, 7076515</b> Bushing. Caster bushing. Fits support arm.								
	7/8"	1-1/8"	1-1/4"	--	--	45-029	5703	--	\$4.00
<b>Toro</b>									
	<b>B1EM22</b> <b>103-5364</b> Bushing. Deck wheel bushing for our B1SB6917 deck wheel. For 52", 60" and 72" cut and Antiscalp rollers.								
	25/64"	5/8"	2-13/16"	--	--	48-007	8586	225-205	\$6.70
	<b>B1MT11</b> <b>112-0347</b> Flanged Bushing Hex kingpin bushing. Fits 38" and 42" cut front engine riders. Package quantities: 5.								
	5/8"	7/8"	5/8"	--	Plastic	45-100	7836	225-532	\$2.00

## Bushings and Spacers

	ID	OD	Height	Flange ID	Material	Oregon	Rotary	Stens	Price
<b>Toro</b>									
	<b>B1EM25</b> <b>1-633581</b> Spacer. Wheel spacer. Fits Lazer Z. Fits our B1WL35, B1WL36, and B1FP109.								
	3/4"	1-1/8"	5/8"	--	--	--	10064	230-225	\$1.50
	<b>B1TO8476</b> <b>28-9290</b> Flanged Bushing. Yoke bushing. Fits commercial mid-size mowers with 36", 37", 44", 52" and 62" cuts and deck models 30136, 30137, 30144, 30152, and 30162.								
	1-1/8"	1-3/8"	1"	--	--	--	8476	--	\$6.20
	<b>B1CO8434</b> <b>62-4340</b> Bushing. Spanner bushing. Fits Groundsmaster models 322-D, 325-D and 327-D with 72" decks. For Toro 62-4330, 85-3610, and 92-1655 front caster wheel assemblies.								
	1/2"	47/64"	4"	--	--	--	8434	--	\$6.60
	<b>B1SB339</b> <b>62-5580</b> Flanged Bushing. Graphite impregnated wheel bushing.								
	3/4"	1-3/8"	5/8"	1-1/2"	--	45-079	339	215-145	\$2.60
	<b>B1SB8420</b> <b>68-8980</b> Bushing. Spanner bushing only. Used in our B1SB8439 kit.								
	1/2"	3/4"	3-11/32"	--	--	--	8420	225-367	\$3.80
<b>Troy Built</b>									
	<b>B1SB3305</b> <b>1720327, 1750341, 1750341099</b> Flanged Bushing. Graphite impregnated. Fits 912001-912003 with spec. #000001, 26" Fairway.								
	3/4"	1-3/8"	3/4"	1-9/16"	--	45-098	3305	215-565	\$3.80
<b>Velke</b>									
	<b>B1SB8654</b> <b>VHITCHBUSH</b> Flanged Bushing. Fits Velke sulkies.								
	1/2"	3/4"	1"	15/16"	--	--	8654	225-276	\$2.00
	<b>B1CO8434</b> <b>VKSPNNER</b> Bushing. Spanner bushing only.								
	1/2"	47/64"	4"	--	--	--	8434	--	\$6.60
	<b>B1CO34</b> <b>VPIVOT</b> Flanged Bushing. Fits Velke sulkies.								
	7/8"	1-1/8"	1"	1-1/2"	--	45-127	5713	225-722	\$3.20
<b>Walker</b>									
	<b>B1CO8076</b> <b>5414-3</b> Spacer. Wheel spacer used in our B1CO8319 bearing kit. Fits our B1CO7982 wheel assembly.								
	3/8"	5/8"	3-1/2"	--	--	--	8076	--	\$7.50



	ID	OD	Height	Flange ID	Material	Oregon	Rotary	Stens	Price
<b>Walker</b>									
	<b>B1CO8211</b> 5683 Flanged Bushing. Caster bushing. Fits 36", 42", 48" 54" and 62" ZTR mowers.								
	1"	1-1/4"	1-1/4"	1-1/2"	--	--	8211	--	\$4.20
<b>Wright</b>									
	<b>B1CO34</b> 14990003 Flanged Bushing. Caster yoke support arm bushing. Fits Sport and Stander.								
	7/8"	1-1/8"	1"	1-1/2"	--	45-127	5713	225-722	\$3.20









Visit our secured website and place  
your order 24/7 at:  
[www.jdv-belts.com](http://www.jdv-belts.com)











**XHT and Predator quality begins with the steel**

**1**  
Our steel incorporates boron, carbon, manganese, and other materials that ensure that it is the perfect steel for lawn-mower blades. It is amazingly strong, yet still able to be sharpened in order to provide a perfect cut for your lawn. This steel is then loaded into our press where it is stamped to the exact specifications of the original blade. How do we ensure this? Turn to page 235 to find out.

























**Ariens**

JAYDEE P/N	LENGTH	CH-D	OH DIA	C TO C	WIDTH	THICK	APPLICATION	OREGON	ROTARY	STENS	PRICE
	<b>OEM#: 30278, 3027859, 3027851</b> - (3) blades for 48" cut. (2) B1AR1001 & (1) SB3326 for 60" cut.										
<b>B1SB3326</b>	16-5/8"	3/4"	--	--	2-1/2"	.180	High Lift	--	3326	305-603	\$13.80
	<b>OEM#: 31237, 3123759, 3123751</b> - (3) blades for 48" cut. Deck 831031 GT.										
<b>B1SB6060</b>	16-5/8"	3/4"	--	--	2-1/2"	.204	--	91-003	6060	305-771	\$16.30
	<b>OEM#: 35355, 13350, 35975, 3535551</b> - (2) blades for 38" cut. Deck series 93500										
<b>B1SB6061</b>	19-7/16"	3/4"	--	--	2-3/4"	.187	--	--	6061	320-200	\$16.40
	<b>OEM#: 36247, 3624759, 3624751</b> - (2) blades for 40" cut. Front engine rider model YT13, YT14, YT15										
<b>B1SB6254</b>	20-5/16"	3/4"	--	--	2-1/2"	.204	--	91-015	6254	305-589	\$19.00
	<b>OEM#: 1137, 11285, 1137059, 1137051</b> - (1) blade for 21" cut. Fits 911000 series Zone Start models										
<b>B1AR1020</b>	20-1/2"	13/32"	--	--	2-3/4"	.165	--	91-005	3322	305-730	\$15.60
	<b>OEM#: 30328</b> - (2) B1AR1001 and (1) B1SB3326 for 60" Cut. Fits Deck 831026										
<b>B1AR1001</b>	22-3/8"	3/4"	--	--	2-3/4"	.187	--	--	--	--	\$20.00
	<b>OEM#: 27493, 2749351</b> - (1) blade for 28" cut riding mower. Use B1SB911 airlifts										
<b>B1AR1005</b>	26-7/8"	7/16"	3/8"	4"	2-3/4"	.187	--	--	6445	--	\$21.00



JAYDEE P/N	LENGTH	CH-D	OH DIA	C TO C	WIDTH	THICK	APPLICATION	OREGON	ROTARY	STENS	PRICE
<b>Ariens</b>											
 <b>OEM#: 27285, 2728551</b> - (1) blade for 28" cut riding mower. Use B1SB911 airlifts											
<b>B1SB3323</b>	28"	3/4"	25/64"	11"	2-3/4"	.180	--	--	3323	--	\$22.00
 <b>OEM#: 27287, 25325, 3514, 2728759, 2728751</b> - (1) blade for 30" cut rear engine rider. Use B1SB911 airlifts											
<b>B1AR1025</b>	30"	3/4"	13/32"	11"	2-3/4"	.187	--	91-012	2137	305-839	\$23.00
<b>AYP</b>											
 <b>OEM#: 25321, 9480R, 9484H</b> - (3) blades for 42" cut. Fits Sears model 917.253250											
<b>B1EP1000</b>	14-5/8"	1-1/4"	15/32"	3"	2-1/2"	.187	--	95-010	1020	340-562	\$10.40
 <b>OEM#: 25118, 122218X</b> - (3) blades for 42" cut.											
<b>B1SB1019</b>	14-5/8"	5/8"	5/16"	1-3/8"	2-1/2"	.150	--	--	1019	340-604	\$12.60
 <b>OEM#: 25034, 25034R, 106635X, 122265X</b> - (3) blades for 44" cut.											
<b>B1EP1001</b>	15-3/8"	3/8"	--	--	2-1/4"	.187	--	95-014	2162	340-034	\$12.00
 <b>OEM#: 130652</b> - (3) blades for 44" cut. High performance											
<b>B1EP1015</b>	15-3/8"	5 point star	--	--	2-1/4"	.165	--	95-006	6205	340-145	\$12.00
 <b>OEM#: 130652, 130652MS</b> - (3) blades for 44" cut.											
<b>B1EP1021</b>	15-3/8"	5 point star	--	--	2-1/4"	.187	Heavy-Duty	95-049	6263	340-145	\$12.00
 <b>OEM#: 145708, 152443, 163819, 159705, 170698, 176084, 157033, 403107</b> (3) blades for 46" cut. Fits AYP, Sears, Husky, and Poulan											
<b>B1EP1027</b>	15-1/2"	5 point star	--	--	2-1/4"	.165	Mulching	95-045	6495	340-038	\$12.60
 <b>OEM#:157033, 152443, 403107</b> - (3) blades for 46" cut. Fits AYP, Sears, Husky, and Poulan.											
<b>B1EP1026</b>	15-1/2"	5 point star	--	--	2-1/4"	.187	Heavy-Duty	--	9170	--	\$11.80
 <b>OEM#: 145708, 152443, 163819</b> - (3) blades for 46" cut.											
<b>B1EP1031</b>	15-1/2"	5 point star	--	--	2-1/4"	.156	Mulching	95-045	9170	340-030	\$9.70
 <b>OEM#: 25322R</b> - (3) blades for 48" cut.											
<b>B1SB2690</b>	16-5/8"	1-1/4"	15/32"	3"	2-1/2"	.187	--	95-011	2690	340-570	\$14.00

Replacement Blades











JAYDEE P/N	LENGTH	CH-D	OH DIA	C TO C	WIDTH	THICK	APPLICATION	OREGON	ROTARY	STENS	PRICE
<b>AYP</b>											
 <b>OEM#: 173921</b> - (3) blades for 48" cut.											
<b>B1EP1040</b>	16-2/3"	5 point star	--	--	2-1/2"	.187	Mulching	95-068	10377	340-091	\$13.90
 <b>OEM#: 173920, 180054</b> - (3) blades for 48" cut.											
<b>B1EP1035</b>	16-3/4"	5 point star	--	--	2-1/2"	.197	High Lift	95-062	9907	340-222	\$14.00
 <b>OEM#: 173920, 180054</b> - (3) blades for 48" cut.											
<b>B1PD1074</b>	16-3/4"	5 point star	--	--	2-1/2"	.197	Mulching	96-615	--	--	\$14.00
 <b>OEM#: 121798X</b> - (3) blades for 50" cut. Fits front engine lawn tractor											
<b>B1EP1013</b>	17-3/8"	3/8"	--	--	2-1/4"	.187	--	--	6195	340-125	\$12.00
 <b>OEM#: 21789, 137380</b> - (3) blades for 50" cut. Front engine lawn tractor											
<b>B1EP1014</b>	17-3/8"	5 point star	--	--	2-1/4"	.165	--	95-018	6196	340-149	\$12.20
 <b>OEM#: 137380, 21798</b> - (3) blades for 50" cut.											
<b>B1EP1022</b>	17-3/8"	5 point star	--	--	2-1/4"	.187	Heavy-Duty	95-050	6264	--	\$12.40
 <b>OEM#:131321, 137415</b> - (2) blades for 36" cut.											
<b>B1EP1017</b>	18"	5 point star	--	--	2-1/4"	.187	Heavy-Duty	95-046	6219	340-166	\$12.00
 <b>OEM#: 140101</b> - (2) blades for 36" cut.											
<b>B1SB10841</b>	18"	5 point star	--	--	2-1/4"	.150	Mulching	--	10841	340-046	\$16.00
 <b>OEM#: 127841, 138496</b> - (2) blades for 36" cut.											
<b>B1EP1008</b>	18-1/8"	5 point star	--	--	2-1/4"	.156	--	95-036	6123	340-153	\$11.20
 <b>OEM#: 1726453-</b> (3) blades for 50" cut. Fits Sears Craftsman 26 HP ZTS 7500 mowers											
<b>B1SP2905</b>	18-9/64"	3/4"	13/32"	2-9/16"	2"	.197	--	91-706	10094	345-070	\$13.60
 <b>OEM#: 25645, 71285, 98111, 105210X</b> - (2) blades for 36" cut.											
<b>B1EP1002</b>	18-3/16"	3/8"	--	--	2-1/2"	.134	--	95-012	3358	340-588	\$9.00

JAYDEE P/N	LENGTH	CH-D	OH DIA	C TO C	WIDTH	THICK	APPLICATION	OREGON	ROTARY	STENS	PRICE
<b>AYP</b>											
 <b>OEM#: 120262X, 126338X</b> - (2) blades for 36" cut.											
<b>B1EP1007</b>	18-1/4"	3/8"	--	--	2-1/4"	.187	High Lift	95-034	6120	340-016	\$19.00
 <b>OEM#: 187254, 187256</b> - (3) blades for 54" cut. Fits Sears, Husqvarna and Poulan Pro											
<b>B1EP1050</b>	18-1/2"	5 point star	--	--	3"	.197	--	95-072	11180	340-226	\$14.00
 <b>OEM#: 131322, 138497</b> - (2) blades for 38" cut.											
<b>B1EP1016</b>	19"	5 point star	--	--	2-1/4"	.187	Heavy-Duty	95-047	6218	340-170	\$13.00
 <b>OEM#:131322, 138497</b> - (2) blades for 38" cut.											
<b>B1PD1072</b>	19-3/16"	5 point star	--	--	2-1/4"	.187	Mulching	95-601	--	--	\$19.80
 <b>OEM#:121263X, 123431X, 143978X</b> - (2) blades for 38" cut.											
<b>B1EP1006</b>	19-1/4"	3/8"	--	--	2-1/4"	.187	High Lift	95-031	6105	340-022	\$17.00
 <b>OEM: 104418XR, 104418 X</b> - Use with (2) B1EP1003 for bagging. Notched to fit as cross-blade. (2) blades for 38" cut.											
<b>B1SB6015</b>	19-5/16"	3/8"	--	--	2-1/4"	.150	--	--	6015	340-133	\$15.80
 <b>OEM#:127842, 138497</b> - (2) blades for 38" cut.											
<b>B1EP1009</b>	19-5/16"	5 point star	--	--	2-1/4"	.156	--	95-033	6124	340-162	\$11.00
 <b>OEM#:134148, 13977, 424692-</b> (2) blades for 38" cut. Fits front engine rider											
<b>B1EP1012</b>	19-5/16"	5 point star	--	--	2-1/4"	.134	Mulching	95-003	6190	340-079	\$11.00
 <b>OEM#:25036, 25036R, 106634X, 100669K</b> - (2) blades for 38" cut. Use with (2) B1SB6015 for bagging. Blades Cross											
<b>B1EP1003</b>	19-3/8"	3/8"	--	--	2-1/4"	.156	--	95-015	3392	340-042	\$11.00
 <b>OEM#:69229, 850972, 33203, 56400, 701211</b> - (1) blade for 20" cut walk-behind											
<b>B1EP1004</b>	20"	5/8"	3/8"	1-7/8"	2-1/2"	.156	--	95-024	6037	340-012	\$11.00
 <b>OEM#:129277, 131694, 133346, 134871, 145106, 75223</b> - (1) blade for 20" cut walk-behind											
<b>B1EP1018</b>	20"	5/8"	3/8"	1-7/8"	2-1/4"	.134	Mulching	95-051	6235	340-157	\$12.20











Replacement Blades











JAYDEE P/N	LENGTH	CH-D	OH DIA	C TO C	WIDTH	THICK	APPLICATION	OREGON	ROTARY	STENS	PRICE
<b>AYP</b>											
 <b>OEM#:204340218, 340218, 752233</b> (1) blade for 20" cut walk-behind. Sears model 917.380542											
<b>B1EP1025</b>	20"	5/8"	3/8"	1-7/8"	2"	.134	Mulching	95-044	--	340-218	\$11.70
 <b>OEM#:168720, 175450 - (2) blades for 42" rear discharge.</b> Left side blade. Right hand rotation											
<b>B1SB6484</b>	21"	5 point star	--	--	5-5/8"	.150	--	--	6484	--	\$24.00
 <b>OEM#:168721, 175451 - (2) blades for 42" rear discharge.</b> Right side blade. Left hand rotation											
<b>B1SB6485</b>	21"	6 point star	--	--	5-5/8"	.150	--	--	6485	--	\$25.00
 <b>OEM#:165833, 175064, 189028, 406712 - (1) blade for 21" cut walk behind</b>											
<b>B1EP1029</b>	21"	5/8"	3/8"	1-7/8"	2-1/4"	.134	Mulching	--	9810	340-248	\$11.50
 <b>OEM#:134149, 127843, 138498, 156105, 138971 - (2) blades for 42" cut.</b>											
<b>B1EP1020</b>	21"	5 point star	--	--	2-1/4"	.187	Heavy-duty	95-048	6262	340-440	\$11.20
 <b>OEM#:138498, 127843, 131323, 138971 - (2) blades for 42" cut.</b>											
<b>B1EP1010</b>	21"	5 point star	--	--	2-1/4"	.156	--	95-032	6125	340-178	\$12.30
 <b>OEM#:134149, 133288, 24676 - (2) blades for 42" cut.</b>											
<b>B1EP1011</b>	21"	5 point star	--	--	2-1/4"	.134	Mulching	95-005	6189	340-066	\$11.50
 <b>OEM#:133288, 134419, 139775, 24676- (2) blades for 42" cut. Heavy-duty.</b>											
<b>B1EP1023</b>	21"	5 point star	--	--	2-1/4"	.187	Mulching	95-019	--	340-054	\$14.90
 <b>OEM#:139775, 127843, 138498, 138971, 134149, 131323, 133128</b> (2) blades for 42" cut. Front engine rider											
<b>B1PD1073</b>	21-3/32"	5 point star	--	--	2-3/4"	.197	Mulching	96-900	6422	--	\$13.60
 <b>OEM#:127843, 131323, 133128, 134149, 138971, 138498, 139775</b> (2) blades for 42" cut											
<b>B1PD5073</b>	21-3/32"	5 point star	--	--	2-1/2"	.197	Mulching	96-900	6422	302-536	\$14.60
 <b>OEM#:48126, 88174 - (1) blade for 22" cut walk-behind.</b> (1) blade for BBC models.											
<b>B1SB6220</b>	21-11/16"	1"	1/2"	3-11/16"	2-1/2"	.187	--	--	6220	--	\$17.00



JAYDEE P/N	LENGTH	CH-D	OH DIA	C TO C	WIDTH	THICK	APPLICATION	OREGON	ROTARY	STENS	PRICE
<b>AYP</b>											
 <b>OEM#:33219, 69234, 69334, 850973</b> - (1) blade for 22" cut walk-behind.											
<b>B1EP1005</b>	21-5/8"	5/8"	3/8"	1-7/8"	2-1/2"	.156	--	95-023	6038	340--008	\$11.00
 <b>OEM#:103256X, 103524X</b> - (1) blade for 22" walk-behind											
<b>B1SB6106</b>	21-3/4"	3/8"	--	--	2-1/2"	.150	--	95-022	6106	340-620	\$13.00
 <b>OEM#:141114, 141443, 134768, 157101, 335256, 114886</b> (1) blade for 22" cut. Fits models HW706D, HW906D, HWRBSP22525A, WHT45A, HWT450A, HWT450B, J455SDE, J555RDEB											
<b>B1EP1019</b>	21-3/4"	5/8"	3/8"	1-7/8"	2-1/4"	.134	Mulching	95-021	6236	340-137	\$11.00
 <b>OEM#:850973, 33219, 141443, 141114, 157101, 69334, 752234, 134768</b> (1) blade for 22" cut walk-behind.											
<b>B1PD1014</b>	21-3/4"	5/8"	3/8"	1-7/8"	2-1/2"	.197	Mulching	95-602	6493	--	\$16.00
 <b>OEM#:752234, 204335256</b> - (1) blade for 22" cut walk-behind											
<b>B1EP1024</b>	21-3/4"	5/8"	3/8"	1-7/8"	2"	.134	Mulching	95-043	--	340-256	\$12.80
 <b>OEM#:176135</b> - (1) blade for 21" cut Craftsman mowers											
<b>B1EP1051</b>	21-7/64"	5/8"	3/8"	1-7/8"	2-3/4"	.156	--	--	--	--	\$12.00
 <b>OEM#:403107, 405380</b> - (2) blades for 46" cut.											
<b>B1HV1017</b>	22-7/8"	5 point star	--	--	2-3/4"	.156	--	95-070	12242	340-230	\$12.50
<b>Bad Boy</b>											
 <b>OEM#:038-4820-00</b> - (2) blades for 32" cut. (3) blades for 48" cut.											
<b>B1BC1201</b>	16-1/4"	5/8"	11/32"	1-5/8"	2-1/2"	.250	Notched	93-005	2172	310-045	\$12.20
 <b>OEM#:038-4820-00</b> - (2) blades for 32" cut. (3) blades for 48" cut.											
<b>B1PD5005</b>	16-1/4"	5/8"	--	--	2-1/2"	.250	Mulching	90-716	6296	--	\$22.80
 <b>OEM#:038-3000-00</b> - (2) blades for 36" cut. (3) blades for 52" cut.											
<b>B1BC1202</b>	18"	5/8"	--	--	2-1/2"	.250	Notched	93-006	2173	310-052	\$12.10
 <b>OEM#:038-3000-00</b> - (2) blades for 36" cut. (3) blades for 52" cut.											
<b>B1PD5008</b>	18"	5/8"	--	--	2-1/2"	.250	Mulching	90-718	6294	303-116	\$21.60

Replacement Blades

JAYDEE P/N	LENGTH	CH-D	OH DIA	C TO C	WIDTH	THICK	APPLICATION	OREGON	ROTARY	STENS	PRICE
<b>Bad Boy</b>											
		<b>OEM#:038-6050-00-</b> (3) blades for 60" cut.									
<b>B1GR2001</b>	20-1/2"	5/8"	--	--	2-1/2"	.250	High Lift	91-253	6180	315-792	\$16.70
<b>Bobcat</b>											
		<b>OEM#:32061A, 32061</b> - (2) blades for 32" cut. (3) blades for 48" cut.									
<b>B1BC1200</b>	16-1/4"	5/8"	1/4"	1-5/8"	2-1/2"	.187	Notched	93-002	1009	310-003	\$11.40
		<b>OEM#:32061A, 03239</b> - (2) blades for 32" cut. (3) blades for 48" cut. Heavy-duty									
<b>B1BC1201</b>	16-1/4"	5/8"	11/32"	1-5/8"	2-1/2"	.250	Notched	93-005	2172	310-045	\$13.00
		<b>OEM#:112111-01</b> - (2) blades for 32" cut. (3) blades for 48" cut. Fits XM series.									
<b>B1BC1204</b>	16-1/4"	5/8"	--	--	2-1/2"	.197	High Lift	93-009	3400	310-102	\$12.30
		<b>OEM#:32061A, WM132022, 32022HD, 03239, WMTA32061, 112111-01, 32061</b> - (2) blades for 32" cut. (3) blades for 48" cut.									
<b>B1PD5005</b>	16-1/4"	5/8"	--	--	2-1/2"	.250	Mulching	96-716	6296	302-616	\$21.90
		<b>OEM#:32022A, 32022HD</b> - (2) blades for 36" cut. (3) blades for 54" cut. Heavy-duty.									
<b>B1BC1202</b>	18"	5/8"	--	--	2-1/2"	.250	Notched	93-006	2173	310-052	\$12.70
		<b>OEM#:112111-02</b> - (2) blades for 36" cut. (3) blades for 54" cut. Fits XM series.									
<b>B1BC1205</b>	18"	5/8"	--	--	2-1/2"	.197	High Lift	93-010	3401	310-110	\$12.40
		<b>OEM#:112243-02</b> - (2) blades for 36" cut. (3) blades for 54" cut.									
<b>B1SB6183</b>	18"	5/8"	--	--	2-1/2"	.204	Low Lift	--	6183	--	\$12.50
		<b>OEM#:112111-02</b> - (2) blades for 36" cut. (3) blades for 52" cut.									
<b>B1PD5008</b>	18"	5/8"	--	--	2-1/2"	.250	Mulching	90-718	6294	302-618	\$21.90
		<b>OEM#:42180B, WM142180B</b> - (3) blades for 61" cut.									
<b>B1BC1203</b>	21"	5/8"	--	--	2-1/2"	.250	Notched	93-008	2174	310-078	\$14.70
		<b>OEM#:112111-03</b> - (3) blades for 61" cut. Fits XM series.									
<b>B1BC1206</b>	21"	5/8"	--	--	2-1/2"	.250	Notched	93-011	3402	310-086	\$14.60







JAYDEE P/N	LENGTH	CH-D	OH DIA	C TO C	WIDTH	THICK	APPLICATION	OREGON	ROTARY	STENS	PRICE
<b>Bobcat</b>											
 OEM#:112111-03 - (3) blades for 61" cut.											
B1EM1803	21"	5/8"	--	--	2-1/2"	.250	Low Lift	--	--	303-188	\$16.10
 OEM#:112243-03 - (3) blades for 61" cut. (7) blades for 10.5' cut.											
B1SB6272	21"	5/8"	--	--	2-1/2"	.240	--	93-013	6272	--	\$16.10
 OEM#:42180B, WM142180B, 112111-03 - (3) blades for 61" cut.											
B1PD5010	21"	5/8"	--	--	2-1/2"	.250	Mulching	96-702	6299	302-821	\$23.50
 OEM#:42180B, WM142180B, 112111-03 - (3) blades for 61" cut. Offset blade.											
B1PD5206	21"	5/8"	--	--	2-1/2"	.250	Mulching	96-702	--	--	\$20.30
 OEM#:42139B, 112111-04 - (3) blades for 74" cut. Heavy-duty.											
B1SB3329	25"	5/8"	--	--	2-1/2"	.250	Notched	93-007	3329	--	\$20.40
<b>Bolens</b>											
 OEM#:1727926, 1772144 -(3) blades for 42" cut. Fits models 18300, 30042R, 30042S.											
B1SB6066	15-5/16"	3/8"	3/8"	2-3/4"	2"	.187	--	91-097	6066	310-326	\$12.30
 OEM#:1738571, 1772145- (3) blades for 48" cut. Fits models 30048S, 30048E, 18336, 19211.											
B1SB6068	17"	3/8"	3/8"	2-3/4"	2"	.187	--	91-096	6068	310-300	\$12.80
<b>Bunton</b>											
 OEM#:174-7640- (2) blades for 36" cut. Fits models 30036S and 31036S.											
B1SP2900	18-1/2"	3/4"	13/32"	2-9/16"	2"	.187	--	91-713	6069	345-108	\$12.40
 OEM#:PL4055, P1255, PC2005, PC1255 - (2) blades for 32"cut. (3) blades for 48" cut. For flat front deck											
B1UN3212	16"	5/8"	--	--	2-1/2"	.197	Low Lift	--	3373	--	\$9.90
 OEM#:PL4205 - (3) blades for 48"cut. Gear drive and Hydro drive. Midsize V-deck.											
B1BU1301	16-1/2"	5/8"	--	--	2-1/2"	.197	High Lift	91-068	6116	310-177	\$11.70
 OEM#:A48110 - (3) blades for 48" cut. Gear drive and Hydro drive Midsize V-deck.											
B1PD5006	16-1/2"	5/8"	--	--	2-1/2"	.250	Mulching	96-735	6300	302-617	\$19.00











**Quality at every single step**

Quality does not happen accidentally. XHT and Predator blades reflect our disciplined and determined pursuit of perfection at every step in the process. This ensures that our blades will live up to the most demanding expectations: yours. Once the blades are stamped, machines check and humans verify the integrity of the blade. What happens next? Turn to page 251 to find out.











**2**













JAYDEE P/N	LENGTH	CH-D	OH DIA	C TO C	WIDTH	THICK	APPLICATION	OREGON	ROTARY	STENS	PRICE
<b>Bunton</b>											
 <b>OEM#:PL4206</b> - (2) blades for 36" cut. (3) blades for 52" cut.											
<b>B1BU1300</b>	18"	5/8"	--	--	2-1/2"	.197	High Lift	91-064	6014	355-061	\$12.90
 <b>OEM#:P2005</b> - (2) blades for 36" cut. (3) blades for 52" cut.											
<b>B1SB3374</b>	18"	5/8"	--	--	2-1/2"	.204	--	--	3374	--	\$15.20
 <b>OEM#:P2005, PL4206-</b> (2) blades for 36" cut. (3) blades for 52" cut.											
<b>B1PD5008</b>	18"	5/8"	--	--	2-1/2"	.250	Mulching	90-718	6294	303-116	\$20.60
 <b>OEM#:PC005, PL4207-</b> (3) blades for 61" cut.											
<b>B1SB6141</b>	21"	5/8"	--	--	2-1/2"	.203	--	91-069	6141	310-185	\$18.00
 <b>OEM#:79-117, PC005, PL4207-</b> (3) blades for 61" cut.											
<b>B1EM1803</b>	21"	5/8"	--	--	2-1/2"	.250	Low Lift	--	--	303-188	\$16.90
 <b>OEM#:PC005-</b> (3) blades for 61" cut.											
<b>B1PD5010</b>	21"	5/8"	--	--	2-1/2"	.250	Mulching	96-702	6299	302-821	\$25.10
<b>Case</b>											
 <b>OEM#:C12262, C24442-</b> (3) blades for 44" cut. Left hand cut.											
<b>B1SB3332</b>	15-9/16	1-1/4"	7/16"	2-5/8"	2-1/2"	.187	--	91-112	3332	310-763	\$12.20

JAYDEE P/N	LENGTH	CH-D	OH DIA	C TO C	WIDTH	THICK	APPLICATION	OREGON	ROTARY	STENS	PRICE
<b>Cub Cadet</b>											
		<b>OEM#:759-3848, 759-3844, 477-598-R3, 490-471-R1</b> (2) B1SB6075 and (1) B1SB6077 for 42" cut.									
<b>B1SB6075</b>	11"	3/4"	--	--	2-1/2"	.204	--	91-321	6075	325-787	\$15.00
		<b>OEM#:742-3010, 759-3818-</b> (1) B1CC1412 and (2) B1CC1402 for 46" cut. Center blade.									
<b>B1CC1412</b>	14-7/8"	3/4"	--	--	3"	.197	--	91-327	--	325-134	\$15.00
		<b>OEM#:59704-C1, 742-3002, 759-3812-</b> (3) blades for 44" cut.									
<b>B1CC1400</b>	15-1/8"	3/4"	--	--	2-1/2"	.197	--	91-414	6081	325-837	\$11.00
		<b>OEM#:759-3939-</b> (3) blades for 44" cut. Used on mowers from 2001 to present									
<b>B1SB10636</b>	16"	3/4"	5/16"	2-1/2"	2-1/2"	.204	--	91-073	10636	325-442	\$14.80
		<b>OEM#:489393-R1, 490475-R1, 7423036, 759-3847</b> (2) B1SB6074 and (1) B1SB6073 for 48" cut.									
<b>B1SB6074</b>	16-1/16"	3/4"	--	--	2-1/2"	.204	--	--	6074	--	\$15.70
		<b>OEM#:742-3011, 759-3819-</b> (2) B1CC1402 and (1) B1CC1412 for 46" cut. Outside blade									
<b>B1CC1402</b>	16-1/4"	3/4"	--	--	3"	.197	--	91-330	--	325-142	\$16.60
		<b>OEM#:759-3825, 742-3019, 742-3025-</b> (3) blades for 48" cut. Fits model GT2000 and Pro midsize walk-behinds									
<b>B1CC1401</b>	16-1/2"	3/4"	5/16"	2-1/2"	2-1/2"	.197	--	91-333	6240	325-841	\$13.90
		<b>OEM#:1005336-</b> (3) blades for 48" cut. Fits M48 Tank models									
<b>B1CC1406</b>	17"	3/4"	--	--	3"	.197	High Lift	--	10361	--	\$13.80
		<b>OEM#:59705-C1, 742-3003, 759-3813-</b> (3) blades for 50" cut.									
<b>B1CC1407</b>	17-1/4"	3/4"	--	--	2-1/2"	.197	--	91-415	6082	325-845	\$12.30
		<b>OEM#:489-392-R1, 759-3846-</b> (2) B1SB6074 and (1) B1SB6073 for 48" cut.									
<b>B1SB6073</b>	17-5/8"	3/4"	--	--	2-1/2"	.203	--	--	6073	--	\$17.40
		<b>OEM#:01010168-</b> (3) blades for 50" cut. Fits Tank Commercial and ZTR Z Force									
<b>B1CC1403</b>	17-7/8"	3/4"	--	--	2-1/2"	.197	High Lift	92-015	11250	325-179	\$12.50









Replacement Blades

JAYDEE P/N	LENGTH	CH-D	OH DIA	C TO C	WIDTH	THICK	APPLICATION	OREGON	ROTARY	STENS	PRICE
<b>Cub Cadet</b>											
 <b>OEM#:742-04068, 759-04047-</b> (3) blades for 50" cut.											
<b>B1CC1419</b>	17-7/8"	3/4"	--	--	2-1/2"	.156	--	98-087	11506	325-290	\$15.80
 <b>OEM#:742-04056, 742-04053A -</b> (3) blades for 50" cut.											
<b>B1CC1423</b>	17-7/8"	"H" pattern	--	--	3"	.156	High Lift	98-086	11480	335-859	\$13.90
 <b>OEM#:742-04056, 742-04053A-</b> (3) blades for 50" cut.											
<b>B1CC1428</b>	17.9	"H" Pattern	--	--	2-1/2"	.187	Heavy-Duty	--	11507	--	\$11.80
 <b>OEM#:742-3013, 759-3820-</b> (3) blades for 54" cut. Fits models GT and Pro midsize walk-behinds.											
<b>B1CC1410</b>	18-1/2"	3/4"	--	--	3"	.197	--	91-440	6239	325-849	\$14.90
 <b>OEM#:742-0677, 942-0677B-</b> (3) blades for 54" cut.											
<b>B1CC1427</b>	18-1/2"	"H" Pattern	5/16"	2-1/2"	3"	.156	--	98-072	11719	335-855	\$14.20
 <b>OEM#:1005337-</b> (3) blades for 54" cut. Fits M54 Tank models											
<b>B1CC1413</b>	19"	3/4"	--	--	3"	.197	High Lift	98-091	10362	--	\$15.20
 <b>OEM#:742-3009, 759-3817-</b> (2) blades for 38" cut.											
<b>B1CC1404</b>	19-3/8"	3/4"	--	--	3"	.197	--	91-416	6238	325-175	\$15.90
 <b>OEM#:742-3008, 759-3816-</b> (2) blades for 38" cut.											
<b>B1CC1408</b>	19-3/8"	3/4"	--	--	3"	.197	High Lift	91-328	6147	325-167	\$15.20
 <b>OEM#:1004719-</b> (3) blades for 60" cut. Fits Cub Cadet & MTD Pro ZTR's with stamped steel decks.											
<b>B1CC1421</b>	20-1/2"	3/4"	--	--	3"	.197	--	91-144	10383	--	\$17.20
 <b>OEM#:01005338, 02005019-</b> (3) blades for 60" cut. Fits Recon and Tank models.											
<b>B1CC1418</b>	21"	3/4"	--	--	3"	.197	High Lift	98-071	10363	350-098	\$16.60
 <b>OEM#:742-04081, 742-04101, 742-3033, 759-3830-</b> (2) blades for 42" cut.											
<b>B1CC1425</b>	21"	3/4"	5/16"	2-1/2"	2-3/4"	0.165	Mulching	91-058	11475	--	\$14.00



JAYDEE P/N	LENGTH	CH-D	OH DIA	C TO C	WIDTH	THICK	APPLICATION	OREGON	ROTARY	STENS	PRICE
<b>Cub Cadet</b>											
		<b>OEM#:742-3018, 759-3824-</b> (2) blades for 42" cut. Fits models GT 2000 and 1440									
<b>B1CC1405</b>	21-3/16"	3/4"	5/16"	2-1/2"	3"	.197	--	91-332	6237	325-856	\$13.90
		<b>OEM#:547191-R1, 759-3853-</b> (3) blades for 60" cut. Fits models Low Boy 3260 and C3 Danco.									
<b>B1SB6078</b>	21-1/4"	3/8"	17/32"	4-1/2"	2-1/2"	.204	--	91-318	6078	--	\$18.80
		<b>OEM#:742-04312, 942-04312-</b> (2) blades for 42" cut. Fits models LTX1040. 2-in-1 blade for either discharging or bagging.									
<b>B1CC1426</b>	21-1/4"	"H" Pattern	5/16"	2-1/2"	2-1/2"	.156	2-in-1	--	--	--	\$14.60
		<b>OEM#:759-3850, 759-3843, 477-597-R3, 490-473-R1-</b> (1) B1SB6077 and (2) B1SB6075 for 42" cut. For 1968 to 1973 models.									
<b>B1SB6077</b>	22-3/16"	3/4"	--	--	2-1/2"	.204	--	91-322	6077	325-795	\$22.00
<b>Dixie Chopper</b>											
		<b>OEM#:30227-42-</b> (3) blades for 42" cut.									
<b>B1SB6020</b>	14-1/2"	5/8"	--	--	2-1/2"	.203	--	91-501	6020	--	\$14.80
		<b>OEM#:30227-50H-</b> (3) blades for 50" cut. Fits ZTR models									
<b>B1DC1511</b>	17"	5/8"	--	--	2-1/2"	.250	High Lift	91-508	--	--	\$12.40
		<b>OEM#:30227-</b> (3) blades for 50" cut. Fits ZTR models									
<b>B1DC1505</b>	17"	5/8"	--	--	3"	.250	High Lift	91-147	6442	--	\$14.60
		<b>OEM#:30227H, 30227-50-</b> (3) blades for 50" cut.									
<b>B1DC1502</b>	17"	5/8"	--	--	2-1/2"	0.197	Notched	91-502	--	303-144	\$12.90
		<b>OEM#:30227-50-</b> (3) blades for 50" cut.									
<b>B1DC1500</b>	17"	5/8"	--	--	2-1/2"	.197	--	91-502	3372	350-199	\$11.00
		<b>OEM#:30227-50, 30227-50V, 30227-50H, A30227-50N, 30227-N, 30227-H -</b> (3) blades for 50" cut.									
<b>B1PD2007</b>	17"	5/8"	--	--	2-1/2"	.250	Mulching	96-723	6298	303-396	\$14.90

Replacement Blades

JAYDEE P/N	LENGTH	CH-D	OH DIA	C TO C	WIDTH	THICK	APPLICATION	OREGON	ROTARY	STENS	PRICE
<b>Dixie Chopper</b>											
 <b>OEM#:30277-60V-</b> (3) blades for 60" cut.											
<b>B1DC1501</b>	20-1/2"	5/8"	--	--	2-1/2"	.250	Notched	91-506	6083	303-152	\$16.00
 <b>OEM#:30227-60-</b> (3) blades for 60" cut.											
<b>B1DC1503</b>	20-1/2"	5/8"	--	--	2-1/2"	.197	--	91-503	6194	315-511	\$17.20
 <b>OEM#:30227-60, 30227-60V, 30227-60H, A30227-50N-</b> (3) blades for 60" cut.											
<b>B1PD5009</b>	20-1/2"	5/8"	--	--	2-1/2"	.250	Mulching	96-740	6303	302-620	\$22.00
 <b>OEM#:30227-60H-</b> (3) blades for 60" cut.											
<b>B1DC1506</b>	20-1/2"	5/8"	--	--	2-1/2"	.250	High Lift	91-509	6441	315-250	\$16.60
 <b>OEM#:30227-72H-</b> (3) blades for 72" cut. Fits models XXW 2500 and XXW 4000 series											
<b>B1DC1510</b>	24"	5/8"	--	--	2-1/2"	.250	--	91-507	6404	315-254	\$19.00
 <b>OEM#:30227-72N-</b> (3) blades for 72" cut.											
<b>B1DC1507</b>	24"	5/8"	--	--	3"	.250	--	91-515	6833	315-499	\$20.90
<b>Dixon</b>											
 <b>OEM#:6092-</b> (3) blades for 42" cut.											
<b>B1SB1100</b>	14-3/8"	11/16"	--	--	2"	.187	Low Lift	91-500	1100	--	\$13.60
 <b>OEM#:53912954, 6092, 6231, 6236-</b> (3) blades for 42" cut. For ZTR Mowers 428 & 429											
<b>B1DX1601</b>	14-1/2"	11/16"	--	--	2-1/2"	.187	Low Lift	91-166	6086	315-006	\$12.50











**How to properly measure your blade**











**This diagram illustrates the correct way to measure your lawnmower blade**

1. Measure blade length diagonally, cutting tip to cutting tip
2. Measure the diameter of the center hole
3. Measure the center to center distance of outside holes
4. Measure width at the widest part of the blade

**PRODUCT FACTS**

JAYDEE P/N	LENGTH	CH-D	OH DIA	C TO C	WIDTH	THICK	APPLICATION	OREGON	ROTARY	STENS	PRICE
<b>Dixon</b>											
 <b>OEM#:53912954, 6092, 6231, 6236-</b> (3) blades for 42" cut.											
<b>B1DX1602</b>	14-1/2"	11/16"	--	--	2-1/2"	.187	High Lift	91-167	6087	315-036	\$11.60
 <b>OEM#:9229, 9258-</b> (2) blades for 32" cut. (3) blades for 50" cut.											
<b>B1DC1500</b>	17"	5/8"	--	--	2-1/2"	.197	--	91-502	3372	350-199	\$10.90
 <b>OEM#:9265-</b> (3) blades for 50" cut. Fits ZTR models 502 & 503.											
<b>B1SB6088</b>	17"	5/8"	--	--	2-1/2"	.187	High Lift	91-165	6088	--	\$15.20
 <b>OEM#:9258, 9265-</b> (3) blades for 50" cut.											
<b>B1PD2007</b>	17"	5/8"	--	--	2-1/2"	.250	Mulching	96-723	6298	303-396	\$14.00
 <b>OEM#:9443, 9403-</b> (3) blades for 50" cut.											
<b>B1SB6782</b>	17"	11/16"	--	--	2-1/2"	.187	Low Lift	91-158	6782	350-014	\$14.90
 <b>OEM#:1351-</b> (2) blades for 36" cut. Fits ZTR model 361 with catcher.											
<b>B1SB6084</b>	18-7/16"	3/4"	13/32"	2-9/16"	2-3/4"	.187	--	91-169	6084	--	\$16.10
 <b>OEM#:1324, 1893-</b> (2) blades for 36" cut. Fits ZTR model 361 only.											
<b>B1SB6101</b>	18-1/2"	11/16"	--	--	2"	.187	--	--	6101	--	\$14.80
 <b>OEM#:9383-</b> (3) blades for 60" cut.											
<b>B1PD5009</b>	20-1/2"	5/8"	--	--	2-1/2"	.250	Mulching	96-740	6303	302-620	\$24.60
 <b>OEM#:9445-</b> (3) blades for 60" cut.											
<b>B1SB6784</b>	20-1/2"	11/16"	--	--	2-1/2"	.240	--	91-038	6784	315-022	\$18.80
<b>Encore</b>											
 <b>OEM#:253027-</b> Fits Power Thatcher 25T100. Fits our B1SB8524 shaft. 28 blades per set											
<b>B1SB6279</b>	4-1/4"	17/32"	--	--	1"	.117	--	40-701	6279	--	\$2.10
 <b>OEM#:483035, 483024-</b> (2) blades for 32" cut. (3) blades for 48" cut.											
<b>B1SC2800</b>	16-1/2"	5/8"	--	--	2-1/2"	.197	Notched	91-620	3403	340-109	\$12.00











Replacement Blades

JAYDEE P/N	LENGTH	CH-D	OH DIA	C TO C	WIDTH	THICK	APPLICATION	OREGON	ROTARY	STENS	PRICE
<b>Encore</b>											
 <b>OEM#:483035, 453024-</b> (2) blades for 32" cut. (3) blades for 48" cut.											
<b>B1PD5006</b>	16-1/2"	5/8"	--	--	2-1/2"	.250	Mulching	96-735	6300	302-617	\$21.20
 <b>OEM#:363291, 482306, 363046-</b> (2) blades for 36" cut. (3) blades for 52" cut.											
<b>B1SC2801</b>	18"	5/8"	--	--	2-1/2"	.197	Notched	91-622	3404	340-158	\$13.00
 <b>OEM#:363291-</b> (2) blades for 36" cut. (3) blades for 52" cut.											
<b>B1PD5008</b>	18"	5/8"	--	--	2-1/2"	.250	Mulching	91-718	6294	303-116	\$20.80
 <b>OEM#:823006-</b> (3) blades for 61" cut.											
<b>B1EM1803</b>	21"	5/8"	--	--	2-1/2"	.250	Low Lift	--	--	303-188	\$16.80
<b>Exmark</b>											
 <b>OEM#:1-503031-</b> Rake tooth. 4-1/4" x 1" x .120" material. 9/16" hole. Priced and sold individually.											
<b>B1SB6279</b>	4-1/4"	17/32"	--	--	1"	.117	--	--	6279	--	\$2.10
 <b>OEM#:1-653102, 103-2519-</b> (3) blades for 44" cut. Fits Lazer Z.											
<b>B1EM1816</b>	15-1/4"	5/8"	--	--	2-1/2"	.197	Mulching	91-373	6820	355-089	\$13.10
 <b>OEM#:103-6400-</b> (3) blades for 44" cut.											
<b>B1SB11269</b>	15-1/4"	15/16"	--	--	2-1/2"	.204	Notched	92-088	11269	--	\$16.90
 <b>OEM#:1-653101, 103-2529-</b> (3) blades for 44" cut. Fits Lazer HP.											
<b>B1EM1817</b>	15-5/16"	5/8"	--	--	2-1/2"	.197	High Lift	91-369	6821	355-085	\$12.50
 <b>OEM#:1-403059, 1-323515, 103-6583-</b> (2) blades for 32" cut. (3) blades for 48" cut. Heavy-duty.											
<b>B1BC1201</b>	16-1/4"	5/8"	11/32"	1-5/8"	2-1/2"	.250	Notched	91-183	2172	310-045	\$12.80











### Why is it important to balance mower blades?

An unbalanced blade can cause vibrations that can damage mower bearings and crankshafts, reduce power, cause excessive vibration, poor cut quality, and result in an uneven cut. Make sure to balance your blades every time you sharpen. See page 336 for our selection of blade balancers.











JAYDEE P/N	LENGTH	CH-D	OH DIA	C TO C	WIDTH	THICK	APPLICATION	OREGON	ROTARY	STENS	PRICE
<b>Exmark</b>											
 <b>OEM#:1-413438, 103-1577-</b> (2) blades for 32" cut. (3) blades for 48" cut. Fits Turf Tracer, HP Metro, and Viking Units.											
<b>B1EM1805</b>	16-1/4"	5/8"	--	--	2-1/2"	.197	--	--	9487	--	\$13.00
 <b>OEM#:1-100340, 1-323515, 1-403026, 103-2527, 103-6583</b> (2) blades for 32" cut. (3) blades for 48" cut.											
<b>B1BC1200</b>	16-1/4"	5/8"	1/4"	1-5/8"	2-1/2"	.187	Notched	93-002	1009	310-003	\$11.40
 <b>OEM#:1-403086, 1-403148, 103-2517, 103-6581-</b> (3) blades for 48" cut.											
<b>B1EM1815</b>	16-1/4"	5/8"	--	--	2-1/2"	.165	Mulching	91-194	6175	355-028	\$11.70
 <b>OEM#:1-403149, 103-2507, 103-6738-</b> (3) blades for 48" cut.											
<b>B1EM1820</b>	16-1/4"	5/8"	--	--	2-1/2"	.197	Low Lift	--	10718	--	\$14.50
 <b>OEM#:1-403148, 103-6581-</b> (3) blades for 48" cut. Heavy-duty.											
<b>B1SB9988</b>	16-1/4"	5/8"	--	--	2-1/2"	.204	Mulching	91-368	9988	355-028	\$13.30
 <b>OEM#:1-403059, 1-403026, 1-403086-</b> (2) blades for 32" cut. (3) blades for 48" cut.											
<b>B1PD5005</b>	16*-1/4"	5/8"	--	--	2-1/2"	.250	Mulching	96-716	6296	302-616	\$21.00
 <b>OEM#:103-6401-</b> (3) blades for 48" cut.											
<b>B1SB11231</b>	16-1/4"	15/16"	--	--	2-1/2"	.204	High Lift	92-029	11231	355-229	\$13.70
 <b>OEM#:103-6391-</b> (3) blades for 48" cut.											
<b>B1EM1890</b>	16-1/4"	15/16"	--	--	2-1/2"	.197	Mulching	92-026	11240	--	\$10.90
 <b>OEM#:103-8288, 103-8228-S-</b> (3) blades for 46" cut.											
<b>B1EM1881</b>	16-1/4"	15/16"	--	--	3"	.204	Mulching	--	11771	--	\$14.70
 <b>OEM#:103-6396-</b> (3) blades for 48" cut.											
<b>B1SB11279</b>	16-1/4"	15/16"	--	--	2-1/2"	.204	Mulching	96-321	11279	--	\$17.40
 <b>OEM#:103-8370, 109-9390-</b> (3) blades for 46" cut. Fits Triton decks											
<b>B1EM1870</b>	16-17/64"	15/16"	--	--	3"	.197	--	492-061	11770	--	\$15.00

Replacement Blades

JAYDEE P/N	LENGTH	CH-D	OH DIA	C TO C	WIDTH	THICK	APPLICATION	OREGON	ROTARY	STENS	PRICE
<b>Exmark</b>											
 <b>OEM#:103-8251, 109-6460-</b> (3) blades for 46" cut. Fits Triton decks.											
<b>B1EM1871</b>	16-17/64"	15/16"	--	--	3"	.197	High Lift	492-060	12002	--	\$14.30
 <b>OEM#:103-9600-</b> (3) blades for 50" cut. Fits Triton decks.											
<b>B1EM1872</b>	17-1/2"	15/16"	--	--	3"	.197	Medium Lift	492-063	11774	--	\$20.00
 <b>OEM#:103-9605, 109-6461-</b> (3) blades for 50" cut. Fits Triton Decks.											
<b>B1EM1873</b>	17-1/2"	15/16"	--	--	3"	.197	High Lift	492-062	12003	--	\$20.00
 <b>OEM#:1-633484, 103-2518, 103-6582-</b> (2) blades for 36" cut. (3) blades for 52" cut. Fits Viking and Metro.											
<b>B1EM1810</b>	17-29/32"	5/8"	--	--	2-1/2"	.197	Mulching	91-335	6291	355-079	\$12.00
 <b>OEM#:1-633484, 1-303495, 103-2518, 103-6582</b> (2) blades for 36" cut. (3) blades for a 52" cut.											
<b>B1SB6178</b>	17-15/16"	5/8"	--	--	2-1/2"	.160	Mulching	91-218	6178	--	\$13.70
 <b>OEM#:1-603844, 1-603637, 103-3229-</b> (2) blades for 36" cut. (3) blades for 52" cut.											
<b>B1SB6217</b>	18"	1/2"	--	--	2-1/2"	.204	Low Lift	91-170	6217	--	\$13.60
 <b>OEM#:1-603637, 1-603873-</b> (2) blades for 36" cut. (3) blades for 52" cut.											
<b>B1PD1021</b>	18"	1/2"	--	--	2-1/2"	.197	Mulching	96-326	6309	302-244	\$18.00
 <b>OEM#:103-2508-</b> (3) blades for 52" cut.											
<b>B1SB10719</b>	18"	5/8"	--	--	2-1/2"	.204	Low Lift	--	10719	--	\$14.10
 <b>OEM#:1-633482, 1-303146, 103-2528, 103-6584-</b> (2) blades for 36" cut. (3) blades for 52" cut.											
<b>B1EM1802</b>	18"	5/8"	--	--	2-1/2"	.197	Notched	91-312	--	355-044	\$12.70
 <b>OEM#:1-303527, 103-1578-</b> (2) blades for 36" cut. (3) blades for 52" cut. Fits Lazer Z models.											
<b>B1SB10071</b>	18"	5/8"	--	--	2-1/2"	.204	--	91-256	10071	355-061	\$17.90
 <b>OEM#:1-303283, 1-633482, 103-2528, 103-6584-</b> (2) blades for 36" cut. (3) blades for 52" cut											
<b>B1BC1202</b>	18"	5/8"	--	--	2-1/2"	.250	Notched	91-184	2173	310-052	\$12.70



JAYDEE P/N	LENGTH	CH-D	OH DIA	C TO C	WIDTH	THICK	APPLICATION	OREGON	ROTARY	STENS	PRICE
<b>Exmark</b>											
 <b>OEM#:1-303146, 1-303283, 1-303495, 103-6584-</b> (2) blades for 36" cut. (3) blades for 52" cut.											
<b>B1PD5008</b>	18"	5/8"	--	--	2-1/2"	.250	Mulching	90-718	6294	303-116	\$19.70
 <b>OEM#:103-6397-</b> (3) blades for 52" cut.											
<b>B1SB11267</b>	18"	15/16"	--	--	2-1/2"	.204	Mulching	96-322	11267	--	\$18.90
 <b>OEM#:103-6392-</b> (2) blades for 36" cut. (3) blades for 52" cut.											
<b>B1EM1891</b>	18"	15/16"	--	--	2-1/2"	.197	Mulching	92-027	11241	355-275	\$12.70
 <b>OEM#:103-6402-</b> (2) blades for 36" cut. (3) blades for 52" cut.											
<b>B1SB11495</b>	18"	15/16"	--	--	2-1/2"	.204	High Lift	92-030	11495	--	\$15.00
 <b>OEM#:103-9607-</b> (3) blades for 56" cut. Fits Triton decks.											
<b>B1EM1874</b>	19-31/64"	15/16"	--	--	3"	.197	Medium Lift	--	11778	--	\$21.00
 <b>OEM#:103-9606-</b> (3) blades for 56" cut. Fits Triton decks.											
<b>B1EM1875</b>	19-1/2"	15/16"	--	--	3"	.197	High Lift	492-064	12004	355-419	\$21.00
 <b>OEM#:1-633483, 103-2530-</b> (3) blades for 60" cut. Fits Lazer Z and Turf Ranger models.											
<b>B1DC1501</b>	20-1/2"	5/8"	--	--	2-1/2"	.250	Notched	91-624	6083	355-036	\$15.90
 <b>OEM#:1-613112, 103-0301-</b> (3) blades for 60" cut. Fits Lazer Z model.											
<b>B1EM1800</b>	20-1/2"	5/8"	--	--	2-1/2"	.197	Mulching	91-311	6290	355-105	\$13.80

**Blade display racks** (See our blade tools and accessories on pages 335-336)



**Shelf Blade Display Rack**

Holds 14 SKUs of mower blades. Comes with header cards for our most popular blades. Fits on gondola style displays.

**B1AC351** \$230.00











**A-Frame Blade Display Rack**

Holds 22 SKUs of mower blades plus 10 SKUs of edger blades.

**B1AC350** \$390.00



Replacement Blades







JAYDEE P/N	LENGTH	CH-D	OH DIA	C TO C	WIDTH	THICK	APPLICATION	OREGON	ROTARY	STENS	PRICE
<b>Exmark</b>											
 <b>OEM#:1-613111, 1-613112, 1-613250, 1-633483, 103-2530-</b> (3) blades for 60" cut.											
<b>B1PD5009</b>	20-1/2"	5/8"	--	--	2-1/2"	.250	Mulching	96-740	6303	302-620	\$24.00
 <b>OEM#:1-603283, 1-613072, 103-3233-</b> (3) blades for 60" cut. Fits models Explorer, Explorer II, Turf Ranger and Turf Tracer.											
<b>B1EM1801</b>	20-1/2"	1/2"	--	--	2-1/2"	.197	Notched	91-339	6250	--	\$12.50
 <b>OEM#:1-603283, 1-603661-</b> (3) blades for 60" cut. Fits Turf Tracer models.											
<b>B1SB6216</b>	20-1/2"	1/2"	--	--	2-1/2"	.204	Low Lift	91-188	6216	--	\$14.40
 <b>OEM#:1-603283, 1-613072, 103-3232, 103-3233-</b> (3) blades for 60" cut. Fits Explorer, Explorer II, Turf Ranger & Turf Tracer											
<b>B1SB6250</b>	20-1/2"	1/2"	--	--	2-1/2"	.203	High Lift	--	6250	355-233	\$14.60
 <b>OEM#:103-1580-</b> (3) blades for 60" cut.											
<b>B1EM1840</b>	20-1/2"	5/8"	--	--	2-1/2"	.250	--	92-022	--	--	\$15.00
 <b>OEM#:103-6398-</b> (3) blades for 60" cut.											
<b>B1SB11469</b>	20-1/2"	15/16"	--	--	2-1/2"	.204	Mulching	96-749	11469	--	\$21.00
 <b>OEM#:103-6393-</b> (3) blades for 60" cut.											
<b>B1EM1892</b>	20-1/2"	15/16"	--	--	3"	.197	Mulching	92-028	11242	355-295	\$14.00
 <b>OEM#:103-6403, 103-6403-S-</b> (3) blades for 60" cut. Fits Lazer AS, ASX, CT, XS, Z, Turf Ranger, and Turf Tracer Hydro.											
<b>B1EM1880</b>	20-1/2"	15/16"	--	--	2-1/2"	.250	Notched	92-031	11248	355-343	\$19.00
 <b>OEM#:103-8396-</b> (3) blades for 60" cut. Fits Triton decks.											
<b>B1EM1876</b>	20-23/32"	15/16"	--	--	3"	.197	Medium Lift	492-067	11782	355-161	\$21.00
 <b>OEM#:103-8244-</b> (3) blades for 60" cut. Fits Triton decks.											
<b>B1EM1877</b>	20-23/32"	15/16"	--	--	3"	.197	High Lift	492-066	12005	355-177	\$21.00
 <b>OEM#:103-9629-</b> (3) blades for 60" cut.											
<b>B1SB11784</b>	20-3/4"	15/16"	--	--	3"	.204	Mulching	--	11784	302-720	\$21.00

### The blades take shape











Once our blades are stamped, they are sharpened and formed into the shape that you recognize. This process takes an incredible amount of force to bend the steel in order to produce our easily recognizable Predator mulching teeth, mulching humps, air lifts and other features that help provide the performance that you expect in a blade. Turn to page 261 to see what happens next.











**3**



JAYDEE P/N	LENGTH	CH-D	OH DIA	C TO C	WIDTH	THICK	APPLICATION	OREGON	ROTARY	STENS	PRICE
<b>Exmark</b>											
		<b>OEM#:109-5396, 109-5396-S, 103-8107, 103-8107-S-</b> (3) blades for 60" cut.									
<b>B1EM1882</b>	20-3/4"	15/16"	--	--	3"	.204	Mulching	--	11783	355-185	\$18.20
		<b>OEM#:103-9619-</b> (3) blades for 66" cut. Fits Triton decks.									
<b>B1EM1878</b>	22-45/64"	15/16"	--	--	3"	.197	Medium Lift	492-124	11786	355-165	\$19.00
		<b>OEM#:103-9618, 109-6464-</b> (3) blades for 66" cut.									
<b>B1SB12027</b>	22-3/4"	15/16"	--	--	3"	.204	High Lift	--	12027	355-189	\$22.90
		<b>OEM#:1-643006, 103-2531-</b> (3) blades for 72" cut. Fits Lazer Z models.									
<b>B1EM1850</b>	24-7/16"	5/8"	--	--	3"	.197	Notched	91-374	6481	355-117	\$18.20
		<b>OEM#:1-643097, 103-2521-</b> (3) blades for 72" cut. Fits Lazer Z models.									
<b>B1SB9882</b>	24-1/2"	5/8"	--	--	3"	.204	Mulching	91-043	9882	355-113	\$18.90
		<b>OEM#:103-6404-</b> (3) blades for 72" cut. Fits Lazer Z models. Air foil lift blade.									
<b>B1SB11229</b>	24-1/2"	15/16"	--	--	3"	.204	--	--	11229	355-283	\$27.00
		<b>OEM#:103-6394-</b> (3) blades for 72" cut. Fits Lazer Z.									
<b>B1SB11244</b>	24-1/2"	15/16"	--	--	3"	.204	Mulching	92-084	11244	355-279	\$21.00











Replacement Blades

JAYDEE P/N	LENGTH	CH-D	OH DIA	C TO C	WIDTH	THICK	APPLICATION	OREGON	ROTARY	STENS	PRICE
<b>Exmark</b>											
 <b>OEM#:103-9625-</b> (3) blades for 72" cut. Fits Triton decks.											
<b>B1EM1879</b>	24-11/16"	15/16"	--	--	3"	.197	Medium Lift	492-069	11790	355-169	\$22.50
 <b>OEM#:1-513876, 103-3290-</b> (1) blade for 52" cut. Fits right hand side of Exmark Explorer. Left hand cutting edge. Used with our B1SB6405 and B1SB6407											
<b>B1SB6406</b>	26"	1/2"	--	--	2-1/2"	.204	--	--	6406	--	\$18.00
<b>Falls</b>											
 <b>OEM#:352400, H081779, 352642-</b> (1) blade for 20" push mower.											
<b>B1SB1074</b>	19-7/8"	3/8"	3/8" x 1-1/2"	3"	1-3/4"	.150	--	--	1074	--	\$9.40
<b>Ferris</b>											
 <b>OEM#:5061827-</b> (3) blades for 44" cut. Fits IS500Z and IS1500Z.											
<b>B1FE1044</b>	15"	5/8"	--	--	2-1/2"	.250	--	--	--	--	\$11.00
 <b>OEM#:5061827-</b> (3) blades for 44" cut. Fits IS500Z and IS1500Z.											
<b>B1PD5144</b>	15"	5/8"	--	--	2-1/2"	.250	Mulching	--	--	--	\$17.80
 <b>OEM#:1520843-</b> (3) blades for 48" cut.											
<b>B1BC1200</b>	16-1/4"	5/8"	1/4"	1-5/8"	2-1/2"	.187	--	93-002	1009	315-868	\$11.40
 <b>OEM#:5101986-</b> (3) blades for 48" cut. Fits new iCD decks.											
<b>B1FE1048</b>	16-1/4"	5/8"	--	--	2-1/2"	.250	Notched	--	--	--	\$14.90
 <b>OEM#:1520843-</b> (3) blades for 48" cut.											
<b>B1PD5005</b>	16-1/4"	5/8"	--	--	2-1/2"	.250	Mulching	96-716	6296	302-616	\$22.00
 <b>OEM#:1521227-</b> (2) blades for 36" cut. (3) blades for 52" cut.											
<b>B1SC2801</b>	18"	5/8"	--	--	2-1/2"	.197	Notched	91-622	3404	340-158	\$13.00
 <b>OEM#:5101756-</b> (3) blades for 52" cut. Fits new iCD decks.											
<b>B1FE1052</b>	18"	5/8"	--	--	2-1/2"	.250	Notched	--	--	--	\$16.70









JAYDEE P/N	LENGTH	CH-D	OH DIA	C TO C	WIDTH	THICK	APPLICATION	OREGON	ROTARY	STENS	PRICE
<b>Falls</b>											
 <b>OEM#:1520843, 1521227-</b> (2) blades for 36" cut. (3) blades for 52" cut.											
<b>B1PD5008</b>	18"	5/8"	--	--	2-1/2"	.250	Mulching	96-726	6294	303-116	\$19.80
 <b>OEM#:1520842-</b> (3) blades for 61" cut.											
<b>B1BC1203</b>	21"	5/8"	--	--	2-1/2"	.250	Notched	91-209	9987	315-872	\$14.70
 <b>OEM#:1520842, 1520842S-</b> (3) blades for 61" cut. Fits Commercial Pro Cut.											
<b>B1EM1803</b>	21"	5/8"	--	--	2-1/2"	.250	Low Lift	--	--	303-188	\$16.40
 <b>OEM#:5101755-</b> (3) blades for 61" cut. Fits new iCD decks.											
<b>B1FE1061</b>	21"	5/8"	--	--	2-1/2"	.250	Notched	--	--	--	\$18.00
 <b>OEM#:1520842-</b> (3) blades for 61" cut.											
<b>B1PD5010</b>	21"	5/8"	--	--	2-1/2"	.250	Mulching	96-702	6299	302-821	\$22.80
<b>Grasshopper</b>											
 <b>OEM#:320231-</b> (3) blades for 44" cut. (1) B1SB3377 and (2) B1GH1900 for 48" cut.											
<b>B1SB3377</b>	15"	1/2"	--	--	2"	.204	--	91-545	3377	320-028	\$13.90
 <b>OEM#:320233-</b> (3) blades for 44" cut. (1) B1GH1907 and (2) B1GH1906 for 48" cut. Fits models 9548, 9548S, 9348, and 9348S.											
<b>B1GH1907</b>	15"	1/2"	--	--	2-1/2"	.250	--	91-552	6330	--	\$13.90
 <b>OEM#:320232, 320234-</b> (3) blades for 44" cut. (1) B1GH1908 and (2) B1GH1901 for a 48" cut.											
<b>B1GH1908</b>	15"	1/2"	--	--	2"	.197	High Lift	--	3378	320-010	\$11.80
 <b>OEM#:320238-</b> (2) B1GH1906 and (1) B1GH1907 for 48" cut. Fits models 9548, 9548S, 9348, and 9348S.											
<b>B1GH1906</b>	18"	1/2"	--	--	2-1/2"	.250	--	91-535	6323	--	\$13.30
 <b>OEM#:320236-</b> (3) blades for 52" cut. Takes (2) B1GH1900 and (1) B1SB3377 for 48" cut,											
<b>B1GH1900</b>	18"	1/2"	--	--	2"	.197	--	91-546	3379	320-048	\$12.40
 <b>OEM#:320237, 320239-</b> (3) blades for 52" cut. Takes (2) B1GH1901 and (1) B1GH1908 for 48" cut.											
<b>B1GH1901</b>	18"	1/2"	--	--	2"	.197	High Lift	--	3380	320-036	\$12.50



Replacement Blades











JAYDEE P/N	LENGTH	CH-D	OH DIA	C TO C	WIDTH	THICK	APPLICATION	OREGON	ROTARY	STENS	PRICE
<b>Grasshopper</b>											
 <b>OEM#:320236, 320327-</b> (3) blades for 52" cut.											
<b>B1PD1021</b>	18"	1/2"	--	--	2-1/2"	.197	Mulching	96-329	6309	302-244	\$18.00
 <b>OEM#:320244-</b> (3) blades for 61" cut. Contour blade.											
<b>B1GH1905</b>	21"	1/2"	--	--	2-1/2"	.250	--	--	10102	--	\$14.90
 <b>OEM#:320245-</b> (3) blades for 61" cut.											
<b>B1GH1904</b>	21"	1/2"	--	--	2-1/2"	.250	Notched	91-531	--	320-018	\$15.10
 <b>OEM#:320243-</b> (3) blades for 61" cut.											
<b>B1SB3424</b>	21"	1/2"	--	--	2"	.204	High Lift	--	3424	--	\$17.00
 <b>OEM#:320242-</b> (3) blades for 61" cut.											
<b>B1GH1902</b>	21"	1/2"	--	--	2-1/2"	.250	Heavy-Duty	91-547	6167	320-006	\$15.00
 <b>OEM#:320243, 320245-</b> (3) blades for 61" cut. Heavy-duty.											
<b>B1GH1903</b>	21"	1/2"	--	--	2-1/2"	.250	High Lift	91-534	6168	320-014	\$15.00
 <b>OEM#:320242-</b> (3) blades for 61" cut. Heavy-duty.											
<b>B1SB6401</b>	21"	1/2"	--	--	2-1/2"	.240	Medium Lift	--	6401	--	\$18.00
 <b>OEM#:320242, 320243, 320245-</b> (3) blades for 61" cut.											
<b>B1PD1022</b>	21"	1/2"	--	--	2-1/2"	.197	Mulching	96-346	6311	302-248	\$23.00
 <b>OEM#:320250-</b> (3) blades for 72" cut. Heavy-duty.											
<b>B1SB6402</b>	25"	1/2"	--	--	2-1/2"	.240	Low Lift	91-544	6402	320-026	\$22.00
 <b>OEM#:320251-</b> (3) blades for 72" cut. Heavy-duty.											
<b>B1SB6403</b>	25"	1/2"	--	--	2-1/2"	.240	High Lift	--	6403	320-026	\$22.70
<b>Gravely</b>											
 <b>OEM#:08899800, 14668, 34984, 3498451-</b> (3) blades for 40" cut.											
<b>B1GR2002</b>	13-7/8"	5/8"	--	--	2"	.197	--	91-244	1065	320-507	\$8.80



JAYDEE P/N	LENGTH	CH-D	OH DIA	C TO C	WIDTH	THICK	APPLICATION	OREGON	ROTARY	STENS	PRICE
<b>Gravely</b>											
 <b>OEM#:046998, 08899600, 09082400, 8779251-</b> (3) blades for 50" cut. ZTR. Fits models 991006, 992009, 888015, Pro 100, 200 and 300 series.											
<b>B1GR1905</b>	17"	5/8"	--	--	2-1/2"	.250	High Lift	91-251	6181	320-535	\$13.40
 <b>OEM#:46998-</b> (3) blades for 50" cut. Sharpened on four sides.											
<b>B1SB6013</b>	17"	5/8"	--	--	2"	.240	Low Lift	--	6013	--	\$20.00
 <b>OEM#:52928, 8866851-</b> (3) blades for 50" cut. Fits Pro 50 and Pro Master 50.											
<b>B1SB6204</b>	17"	5/8"	--	--	2-1/2"	.240	Mulching	--	6204	--	\$22.00
 <b>OEM#:212850, 2128500, 21285051-</b> (3) blades for 50" cut. ZTR.											
<b>B1SB6214</b>	17"	5/8"	--	--	2-1/2"	.240	--	--	6214	--	\$17.50
 <b>OEM#:88616, 11234, 11234P1, 08899300, 8861651-</b> (3) blades for 50" cut. Fits Pro 50 series.											
<b>B1DC1500</b>	17"	5/8"	--	--	2-1/2"	.197	--	91-502	3372	350-199	\$10.90
 <b>OEM#:046998, 08779251, 08899600-</b> (3) blades for 50" cut.											
<b>B1PD2007</b>	17"	5/8"	--	--	2-1/2"	.250	Mulching	96-723	6298	303-396	\$14.90
 <b>OEM#:42124, 38883, 88166, 08899400-</b> (2) blades for 36" cut. Fits model 38872											
<b>B1SB3381</b>	17-11/16"	5/8"	--	--	2"	.250	High Lift	--	3381	320-511	\$15.00
 <b>OEM#:52927, 8866751-</b> (2) blades for 36" cut. Fits Pro 36 mower.											
<b>B1SB6203</b>	17-11/16"	5/8"	--	--	2-1/2"	.240	Mulching	--	6203	--	\$22.80

Accessories		
<p><b>Sniper Safety Glasses</b>                      Provide 99.9% protection from UVA and UVB rays. Meet and exceed ANSI-Z87+ specifications. Woodland Camo.</p> <p><b>B1SG9141</b>      \$16.00</p> 	<p><b>Ear Plugs</b>                      Reusable silicone earplugs with safety neck cord. Comes in a resealable plastic case for storage when not in use.</p> <p><b>B1AC5605</b>      \$3.00</p> 	<p><b>Go-Jo Hand Cleaner</b>                      Hand cleaner with natural pumice scrubbers is great for removing grease and oil. Use with or without water. 14 oz. tub.</p> <p><b>B1GJ14</b>      \$4.40</p> 











Replacement Blades

JAYDEE P/N	LENGTH	CH-D	OH DIA	C TO C	WIDTH	THICK	APPLICATION	OREGON	ROTARY	STENS	PRICE
 <b>OEM#:25124, 89046, 8904651, 8899000-</b> (2) blades for 40" cut. (3) blades for 60" cut											
<b>B1GR2000</b>	20-1/2"	5/8"	--	--	2"	.250	--	91-247	3339	320-564	\$12.00
 <b>OEM#:046999, 08979651, 08898900-</b> (3) blades for 60" cut. Fits Pro 200 and 300 series											
<b>B1GR2001</b>	20-1/2"	5/8"	--	--	2-1/2"	.250	High Lift	91-253	6180	315-792	\$16.60
 <b>OEM#:46999, 08979651, 08898900-</b> (2) blades for 40" cut. (3) blades for 60" cut. Sharpened on four sides. Fits Pro 200 and 300 series											
<b>B1SB6194</b>	20-1/2"	5/8"	--	--	2"	.240	--	91-253	6194	320-564	\$20.60
 <b>OEM#:52929-</b> (3) blades for 60" cut. Fits Pro Master 300 and Pro 400.											
<b>B1SB6213</b>	20-1/2"	5/8"	--	--	2-1/2"	.240	Mulching	--	6213	--	\$23.40
 <b>OEM#:48864, 08781851-</b> (3) blades for 60" cut. Fits Pro Master 400 series.											
<b>B1SB6285</b>	20-1/2"	5/8"	--	--	2-1/2"	.240	Mulching	91-239	6285	--	\$20.20
 <b>OEM#:46999, 8979651, 8898900, 25124, 8904651-</b> (3) blades for 60" cut.											
<b>B1PD5009</b>	20-1/2"	5/8"	--	--	2-1/2"	.250	Mulching	96-740	6303	302-620	\$24.00
 <b>OEM#:200347, 20034751-</b> (2) blades for 40" cut. Commercial deck.											
<b>B1SB2164</b>	20-1/2"	1"	--	--	2-1/4"	.250	--	--	2164	320-523	\$20.90
 <b>OEM#:047685, 08983851, 8983851, 89838, 08898800-</b> (3) blades for 72" cut.											
<b>B1SB6171</b>	24-1/2"	5/8"	--	--	2-1/2"	.240	--	91-254	6171	320-519	\$24.80
 <b>OEM#:20900, 12860, 20311400, 20311451-</b> (1) blade for 30" cut.											
<b>B1SB3416</b>	29-7/8"	7/8"	--	--	3"	.240	--	--	3416	320-531	\$27.50
<b>Grazer</b>											
 <b>OEM#:9005528, C38042, 9005814, C37930-</b> (3) blades for 52" cut.											
<b>B1SB3370</b>	18"	3/8"	--	--	2-1/2"	.187	Notched	91-270	3370	--	\$18.70











**Why do I need to sharpen my mower blades?**











Dull or poorly sharpened mower blades can lead to many lawn problems. Dull blades can shred grass leaving it susceptible to fungus, disease, and/or infestation. Regular maintenance can help keep your lawn healthy by keeping your mower blades sharp and in balance. Sharp and balanced blades ensure a clean, even cut. See page 336 for Sunbelt's mower blade sharpening tools.



JAYDEE P/N	LENGTH	CH-D	OH DIA	C TO C	WIDTH	THICK	APPLICATION	OREGON	ROTARY	STENS	PRICE
<b>Great Dane</b>											
		<b>OEM#:D18086, GDU10230-</b> (3) blades for 48" cut.									
<b>B1SC2800</b>	16-1/2"	5/8"	--	--	2-1/2"	.197	Notched	91-620	3403	340-109	\$12.00
		<b>OEM#:D18086, GDU10230-</b> (3) blades for 48" cut.									
<b>B1PD5006</b>	16-1/2"	5/8"	--	--	2-1/2"	.250	Mulching	96-735	6300	302-617	\$19.00
		<b>OEM#:D18037, GDU10231-</b> (2) blades for 36" cut. (3) blades for 52" cut.									
<b>B1SC2801</b>	18"	5/8"	--	--	2-1/2"	.197	Notched	91-622	3404	340-158	\$13.00
		<b>OEM#:D18037, GDU10231-</b> (2) blades for 36" cut. (3) blades for 52" cut.									
<b>B1PD5008</b>	18"	5/8"	--	--	2-1/2"	.250	Mulching	90-718	6294	303-116	\$21.80
		<b>OEM#:D18036, GDU10232-</b> (3) blades for 61" cut.									
<b>B1SC2802</b>	21"	5/8"	--	--	2-1/2"	.197	Notched	93-008	3434	340-117	\$13.90
		<b>OEM#:1520842, 1520842S-</b> (3) blades for 61" cut. Fits Commercial Pro Cut.									
<b>B1EM1803</b>	21"	5/8"	--	--	2-1/2"	.250	Low Lift	--	--	303-188	\$16.80
		<b>OEM#:D18036, GDU10232-</b> (3) blades for 61" cut.									
<b>B1PD5010</b>	21"	5/8"	--	--	2-1/2"	.250	Mulching	96-727	6299	302-821	\$25.40
<b>Honda</b>											
		<b>OEM#:72513-758-N00, 3389285-</b> (3) blades for 42" cut. Fits model 4213.									
<b>B1SB6131</b>	14-9/16"	41/64"	--	--	2-3/4"	.187	--	--	6131	--	\$13.20
		<b>OEM#:72511-VA5-000, 1454081, 72511-VA5-J00, 3451820-</b> (1) blade for 19" walk-behind. Fits HR-194 and HR-195.									
<b>B1SB6787</b>	18-7/16"	27/32"	7/16"	3-7/16"	2-1/4"	.150	--	--	6787	--	\$13.70
		<b>OEM#:72513-751-700, 72511-763-C00, 3249737, 2487312-</b> (2) B1SB3382 for 38" cut Fits models 3811 and 3813. New Style									
<b>B1SB3382</b>	19-7/16"	41/64"	--	--	2-3/4"	.187	--	--	3382	--	\$17.00
		<b>OEM#:72513-750-305, 2685113-</b> (1) B1SB3437 and (1) B1SB3438 for 38" cut. Left hand blade. Fits models 3810 SA and 3813 SA.									
<b>B1SB3437</b>	19-7/16"	7/8"	7/16"	3-15/32"	2-1/4"	.150	High Lift	--	3437	--	\$27.00

Replacement Blades

JAYDEE P/N	LENGTH	CH-D	OH DIA	C TO C	WIDTH	THICK	APPLICATION	OREGON	ROTARY	STENS	PRICE
<b>Honda</b>											
		<b>OEM#:72511-758-L00, 72531-758-L00, 72531-777-L00, 72511-771-L00, 3389301</b> (1) B1HN2105 and (1) B1SB6151 for 38" cut. RH cut. Fits models 4514, 4518, 3013, 4013, 2113HD.									
<b>B1SB6151</b>	19-1/2"	5/8"	--	--	2-3/4"	.187	--	--	6151	--	\$22.00
		<b>OEM#:72531-758-L00, 72511-763-C00, 3249737-</b> (1) B1HN2105 and (1) B1SB6151 for 38" cut. LH cut. Fits models 4514, 4518, 3013, 4013, 2113HD.									
<b>B1HN2105</b>	19-1/2"	5/8"	--	--	2-3/4"	.187	--	--	6150	325-068	\$13.00
		<b>OEM#:08750-960-333-</b> (1) blade for 21" cut. Offset blade.									
<b>B1SB6458</b>	20-7/8"	27/32"	7/16"	3-7/16"	2-1/4"	.160	--	91-291	6458	--	\$12.50
		<b>OEM#:08720-VE2-000, 72511-VE2-000, 72511-VG4-K00-</b> (1) blade for 21" walk-behind. Lower blade. Use with our B1SB6430 upper blade.									
<b>B1SB6431</b>	20-7/8"	27/32"	13/32"	3-15/32"	2-1/4"	.095	--	91-516	6431	325-009	\$12.80
		<b>OEM#:72511-VA4-641, 3504230-</b> (1) blade for 21" cut walk-behind. Fits all Hondas 1981 thru 1991.									
<b>B1SB6092</b>	20-7/8"	27/32"	7/16"	3-15/32"	2-1/4"	.150	Mulching	91-296	6092	325-773	\$13.80
		<b>OEM#:72511-VA4-641-</b> (1) blade for 21" cut walk-behind. Fits all Hondas 1981 thru 1991.									
<b>B1HN2107</b>	20-13/16"	27/32"	7/16"	3-15/32"	2-1/4"	.156	High Lift	91-444	6092	--	\$10.60
		<b>OEM#:72511-960-004, 72511-960-020, 72511-VA2-690, 2801595, 3504230</b> - (1) blade for 21" cut walk-behind. Fits models HR214, HR215, HR216, HRA14, HRA16.									
<b>B1HN2100</b>	20-7/8"	27/32"	7/16"	3-7/16"	2-1/4"	.156	--	91-291	2160	325-001	\$12.00
		<b>OEM#:72511-VE1-001, 4513511-</b> (1) blade for 21" cut walk-behind Fits models HRB215 and HRM215.									
<b>B1SB6428</b>	20-15/16"	31/32"	13/32"	3-15/32"	2-1/4"	.134	High Lift	--	6428	325-017	\$13.60
		<b>OEM#:72511-VE6-L10-</b> (3) blades for 61" cut. Fits Commercial Pro Cut.									
<b>B1EM1803</b>	21"	5/8"	--	--	2-1/2"	.250	Low Lift	--	--	303-188	\$17.10
		<b>OEM#:08720-VE2-000, 72531-VE2-000, 72531-VE2-001, 72531-VE2-010-</b> (1) blade for 21" cut walk-behind. Upper blade. Use with out B1SB6431 lower blade.									
<b>B1SB6430</b>	21"	1-17/64"	13/32"	3-15/32"	2-5/8"	.095	--	91-517	6430	325-013	\$13.80
		<b>OEM#:72511-763-A00, 72511-772-L00-</b> (1) blade for 30" rider models H3011 and HTR3009-K1.									
<b>B1SB6153</b>	29-9/16"	41/64"	15/32"	4-5/16"	2-3/4"	.187	High Lift	--	6153	--	\$20.00

JAYDEE P/N	LENGTH	CH-D	OH DIA	C TO C	WIDTH	THICK	APPLICATION	OREGON	ROTARY	STENS	PRICE
<b>Husqvarna</b>											
		<b>OEM#:50 66 87-01, 506 67 65-01, 53 10 050-11-</b> (3) blades for 34" cut. Fits models 850-12									
<b>B1SB6093</b>	11-7/8"	13/32"	5/16"	2-3/8"	2"	.150	--	91-309	6093	--	\$15.90
		<b>OEM#:506 75 15-01-</b> (3) blades for 38" cut. Fits models 970-12									
<b>B1HV2200</b>	13-3/4"	13/32"	5/16"	2-3/8"	2"	.165	--	91-310	50111	--	\$12.80
		<b>OEM#:539 11 20-78-</b> (3) blades for 42" cut. Fits EZ-series 4216 and 4217 models.									
<b>B1SB12122</b>	14-5/8"	5 point star	--	--	2-1/2"	.204	--	--	12122	--	\$17.90
		<b>OEM#:539 10 32-74-</b> (3) blades for 42" cut.									
<b>B1HV1013</b>	14-7/8"	5/8"	--	--	2-1/2"	.197	--	95-045	7010	--	\$12.40
		<b>OEM#:170698, 176084, 157033-</b> (3) blades for 46" cut. Fits AYP, Sears, Husky, and Poulan.									
<b>B1EP1027</b>	15-1/2"	5 point star	--	--	2-1/4"	.165	Mulching	95-045	6495	340-038	\$13.30
		<b>OEM#:157033, 170698, 176084-</b> (3) blades for 46" cut. Fits AYP, Sears, Husky, and Poulan.									
<b>B1EP1026</b>	15-1/2"	5 point star	--	--	2-1/4"	.187	Heavy-Duty	--	9170	--	\$11.80
		<b>OEM#:17036, 76675, 539 10 03-40-</b> (2) blades for 32" cut. (3) blades for 48" cut.									
<b>B1BC1200</b>	16-1/4"	5/8"	1/4"	1-5/8"	2-1/2"	.187	--	93-002	1009	310-003	\$11.90
		<b>OEM#:539 10 03-40-</b> (3) blades for 48" cut.									
<b>B1HV1016</b>	16-1/4"	5/8"	--	--	2-1/2"	.197	--	95-064	6500	--	\$12.00
		<b>OEM#:403059, 403026, 403086, 539 10 14-96-</b> (2) blades for 32" cut. (3) blades for 48" cut.									
<b>B1PD5005</b>	16-1/4"	5/8"	--	--	2-1/2"	.250	Mulching	--	6296	302-616	\$22.00
		<b>OEM#:539 11 34-25-</b> (3) blades for 48" cut.									
<b>B1SB12123</b>	16-1/4"	5 point star	--	--	2-1/2"	.204	--	--	12123	--	\$17.00
		<b>OEM#:539 10 60-40-</b> (2) blades for 32" cut. (3) blades for 48" cut.									
<b>B1SC2800</b>	16-1/2"	5/8"	--	--	2-1/2"	.197	Notched	91-620	3403	340-109	\$12.00











**Ready for heat treatment**

4  
 These blades were part of a roll of steel just a few minutes ago. They have been pressed, formed, sharpened, tested, weighed, measured, and inspected. That is all the simple part of the process. Once all of this is complete, the blades get heat-treated. This part of the process hardens the blades and makes them suitable for extreme mowing conditions. Turn to page 277 for the next step.













JAYDEE P/N	LENGTH	CH-D	OH DIA	C TO C	WIDTH	THICK	APPLICATION	OREGON	ROTARY	STENS	PRICE
------------	--------	------	--------	--------	-------	-------	-------------	--------	--------	-------	-------











**Husqvarna**











	<b>OEM#:532 17 39-21-</b> (3) blades for 48" cut. Fits 48" lawn tractor, and Consumer Z.										
<b>B1EP1040</b>	16-2/3"	5 point star	--	--	2-1/2"	.187	Mulching	--	10377	340-091	\$12.00
	<b>OEM#:532 17 39-20 532 18 00-54-</b> (3) blades for 48" cut. Fits lawn tractor and Consumer Z.										
<b>B1EP1035</b>	16-3/4"	5 point star	--	--	2-1/2"	.197	High Lift	95-062	9907	340-222	\$13.00
	<b>OEM#:173921, 173920-</b> (3) blades for 48" cut.										
<b>B1PD1074</b>	16-3/4"	5 point star	--	--	2-1/2"	.197	Mulching	96-615	--	--	\$14.00
	<b>OEM#:17037, 77344-</b> (2) blades for 36" cut. (3) blades for 52" cut.										
<b>B1BC1202</b>	18"	5/8"	--	--	2-1/2"	.250	Notched	93-006	2173	310-052	\$13.00
	<b>OEM#:539-105-712-</b> (2) blades for 36" cut. (3) blades for 52" cut.										
<b>B1SC2801</b>	18"	5/8"	--	--	2-1/2"	.197	Notched	91-622	3404	340-158	\$12.90
	<b>OEM#:17037, 77344-</b> (2) blades for 36" cut. (3) blades for 52" cut.										
<b>B1PD5008</b>	18"	5/8"	--	--	2-1/2"	.250	Mulching	90-718	6294	302-618	\$20.00
	<b>OEM#:532 13 13-21, 539 11 20-79-</b> (2) blades for 36" cut. (3) blades for 52" cut. Fits Estate Series model ES5221.										
<b>B1EP1017</b>	18"	5 point star	--	--	2-1/4"	.187	Heavy-Duty	95-046	6219	340-166	\$10.60
	<b>OEM#:539 11 20-79-</b> (3) blades for 52" cut. Fits EZ series model 5221.										
<b>B1SB12124</b>	18"	5 point star	--	--	2-1/2"	.204	--	--	12124	--	\$18.40













JAYDEE P/N	LENGTH	CH-D	OH DIA	C TO C	WIDTH	THICK	APPLICATION	OREGON	ROTARY	STENS	PRICE
<b>Husqvarna</b>											
		<b>OEM#:532 12 78-41, 532 13 84-96-</b> (2) blades for 36" cut.									
<b>B1EP1008</b>	18-1/8"	5 point star	--	--	2-1/4"	.156	--	95-036	6123	340-153	\$12.00
		<b>OEM#:532 13 84-97, 532 13 97-74-</b> (2) blades for 38" cut.									
<b>B1EP1016</b>	19"	5 point star	--	--	2-1/4"	.187	Heavy-Duty	95-047	6218	340-170	\$12.50
		<b>OEM#:532 13 13-22, 532 13 84-97-</b> (2) blades for 38" cut.									
<b>B1PD1072</b>	19-3/16"	5 point star	--	--	2-1/4"	.187	Mulching	--	--	--	\$17.60
		<b>OEM#:532 13 41-48-</b> (2) blades for 38" cut. Fits front engine rider.									
<b>B1EP1012</b>	19-5/16"	5 point star	--	--	2-1/4"	.134	Mulching	95-003	6190	340-079	\$12.10
		<b>OEM#:532 12 78-42, 532 13 84-97-</b> (2) blades for 38" cut.									
<b>B1EP1009</b>	19-5/16"	5 point star	--	--	2-1/4"	.156	--	95-033	6124	340-162	\$12.20
		<b>OEM#:539 10 57-11-</b> (3) blades for 61" cut.									
<b>B1SC2802</b>	21"	5/8"	--	--	2-1/2"	.197	Notched	93-008	3434	340-882	\$13.80
		<b>OEM#:539 10 17-33-</b> (3) blades for 61" cut. Fits Commercial Pro Cut.									
<b>B1EM1803</b>	21"	5/8"	--	--	2-1/2"	.250	Low Lift	--	--	303-188	\$16.80
		<b>OEM#:127843, 138971, 532 13 84-98-</b> (2) blades for 42" cut. Fits lawn tractor and Consumer Z models YTH1542XP, YTH1542XPG, LTH1342, and LTH1342A									
<b>B1EP1010</b>	21"	5 point star	--	--	2-1/4"	.156	--	95-032	6125	340-178	\$12.00
		<b>OEM#:134149, 127843, 138498, 156105, 138971-</b> (2) blades for 42" cut. Fits lawn tractor and Consumer Z models YTH1542XP, YTH1542XPG, LTH1342, and LTH1342A.									
<b>B1EP1020</b>	21"	5 point star	--	--	2-1/4"	.187	Heavy-Duty	95-048	6262	340-440	\$11.00
		<b>OEM#:532 13 41-49-</b> (2) blades for 42" cut. Fits lawn tractor and Consumer Z models YTH1542XPG, and YTH1542XP									
<b>B1EP1011</b>	21"	5 point star	--	--	2-1/4"	.134	Mulching	95-005	6189	340-066	\$12.00
		<b>OEM#:532 13 97-75-</b> (2) blades for 42" cut. Fits lawn tractor and Consumer Z models. Heavy-duty.									
<b>B1EP1023</b>	21"	5 point star	--	--	2-1/4"	.187	Mulching	95-019	--	340-054	\$14.60











Replacement Blades

JAYDEE P/N	LENGTH	CH-D	OH DIA	C TO C	WIDTH	THICK	APPLICATION	OREGON	ROTARY	STENS	PRICE
<b>Husqvarna</b>											
		<b>OEM#:539 11 33-12-</b> (3) blades for 61" cut. Fits EZ-Series model 6124.									
<b>B1SB12125</b>	21"	5 point star	--	--	2-1/2"	.204	--	--	12125	--	\$17.90
		<b>OEM#:532 13 84-98, 532 13 41-49, 532 13 97-75-</b> (2) blades for 42" cut. Front engine rider.									
<b>B1PD1073</b>	21-3/32"	5 point star	--	--	2-3/4"	.197	Mulching	95-900	6422	--	\$13.90
		<b>OEM#:532 85 09-73-</b> (1) blade for 22" cut walk-behind.									
<b>B1EP1005</b>	21-5/8"	5/8"	3/8"	1-7/8"	2-1/2"	.156	--	95-023	6038	340-008	\$11.90
		<b>OEM#:141114, 141443, 134768, 157101, 335256, 114886-</b> (1) blade for 22" cut walk-behind.									
<b>B1EP1019</b>	21-3/4"	5/8"	3/8"	1-7/8"	2-1/4"	.134	Mulching	95-021	6236	340-137	\$11.60
		<b>OEM#:532 85 09-73-</b> (1) blade for 22" cut walk-behind.									
<b>B1PD1014</b>	21-3/4"	5/8"	3/8"	1-7/8"	2-1/2"	.197	Mulching	95-602	6493	--	\$16.90
		<b>OEM#:532 40 53-80-</b> (2) blades for 46" cut.									
<b>B1HV1017</b>	22-7/8"	5 point star	--	--	2-3/4"	.156	--	95-070	12242	--	\$12.10
<b>Hustler</b>											
		<b>OEM#:784256-</b> (3) blades for 44" cut. Fits Hustler Z, Super Z and Short Cut.									
<b>B1HS1001</b>	15-5/8"	5/8"	--	--	2-1/2"	.197	--	90-205	10371	350-683	\$14.40
		<b>OEM#:767111-</b> (3) blades for 48" cut. Fits Excel Short Cut.									
<b>B1SB6436</b>	16-31/32"	1/2"	--	--	2-1/2"	.204	--	--	6436	--	\$13.10
		<b>OEM#:783753-</b> (3) blades for 52" cut.									
<b>B1HS1002</b>	17-7/8"	5/8"	--	--	2-1/2"	.197	--	90-206	--	350-691	\$14.20
		<b>OEM#:781898, 795526-</b> (3) blades for 52" cut. Fits Hustler Z, Super Z, and Short Cut Fast Trak models.									
<b>B1HS1003</b>	17-7/8"	5/8"	--	--	3"	.250	--	90-207	10372	350-675	\$18.00
<b>Hustler</b>											
		<b>OEM#:787721-</b> (3) blades for 52" cut Fastrak.									
<b>B1HS1007</b>	17-7/8"	5/8"	--	--	2-1/2"	.197	--	--	--	350-691	\$12.40











JAYDEE P/N	LENGTH	CH-D	OH DIA	C TO C	WIDTH	THICK	APPLICATION	OREGON	ROTARY	STENS	PRICE
<b>Hustler</b>											
 <b>OEM#:30866-</b> (3) blades for 52" cut. Fits Super Z.											
<b>B1SB6730</b>	17-7/8"	1/2"	--	--	2-3/4"	.187	--	91-178	6730	--	\$13.00
 <b>OEM#:797696-</b> (3) blades for 54" cut Fastrak.											
<b>B1HS1008</b>	18-1/2"	5/8"	--	--	2-1/2"	.197	--	--	11856	350-695	\$12.90
 <b>OEM#:601124-</b> (3) blades for 54" cut Fastrak and FasTrak SuperDuty.											
<b>B1PD5145</b>	18-1/2"	5/8"	--	--	2-1/2"	.250	Mulching	--	--	--	\$18.50
 <b>OEM#:770339-</b> (3) blades for 54" cut. Fits Excel Short Cut model.											
<b>B1SB6435</b>	19"	1/2"	--	--	2-1/2"	.204	--	--	6435	--	\$13.90
 <b>OEM#:793794, 794685-</b> (3) blades for 60" XR7 Super Z.											
<b>B1HS1010</b>	20-1/2"	5/8"	--	--	2-1/2"	.197	--	92-037	--	315-511	\$13.80
 <b>OEM#:793794-</b> (3) blades for 60" cut.											
<b>B1HS1005</b>	20-1/2"	5/8"	--	--	2-1/2"	.197	--	92-038	--	315-511	\$14.70
 <b>OEM#:795633-</b> (3) blades for 60" cut. Left hand cut.											
<b>B1HS1006</b>	20-1/2"	5/8"	--	--	2-1/2"	.197	--	--	--	--	\$19.00
 <b>OEM#:795252-</b> (3) blades for 60" cut. Fits Z, Super Z, and XR-7 side discharge.											
<b>B1HS1009</b>	20-15/16"	5/8"	--	--	2-1/2"	.197	--	92-043	--	--	\$14.90
 <b>OEM#:795252-</b> (3) blades for 61" cut. Fits Commercial Pro Cut.											
<b>B1EM1803</b>	21"	5/8"	--	--	2-1/2"	.250	Low Lift	--	--	303-188	\$16.00
 <b>OEM#:782516-</b> (3) blades for 60" cut. Fits ZTR models.											
<b>B1HS1004</b>	21"	5/8"	--	--	3"	.197	--	91-811	10373	350-671	\$21.00
 <b>OEM#:798496-</b> (3) blades for 66" cut. Fits Z, Super Z side discharge deck.											
<b>B1HS1011</b>	22-1/2"	5/8"	--	--	3"	.197	--	92-045	11721	350-689	\$17.80

Replacement Blades











JAYDEE P/N	LENGTH	CH-D	OH DIA	C TO C	WIDTH	THICK	APPLICATION	OREGON	ROTARY	STENS	PRICE
<b>Hustler</b>											
 <b>OEM#:24992-</b> (3) blades for 72" cut. Dual cut, LH and RH cut.											
<b>B1HS1701</b>	23-7/8"	1/2"	--	--	2-3/4"	.197	--	--	--	--	\$19.70
 <b>OEM#:754879-</b> (2) B1SB6628 and (1) B1SB6728 for 72" dual trim heavy-duty deck. (4) B1SB6628 and (3) B1SB6728 for Range Wing mowers. Left hand blade.											
<b>B1SB6628</b>	23-7/8"	1/2"	--	--	2-3/4"	.240	Heavy-Duty	--	6628	--	\$22.00
 <b>OEM#:754853-</b> (2) B1SB6628 and (1) B1SB6728 for 72" dual trim heavy-duty deck. (4) B1SB6628 and (3) B1SB6728 for Range Wing mowers. Right hand blade.											
<b>B1SB6728</b>	23-7/8"	1/2"	--	--	2-3/4"	.240	Heavy-Duty	91-238	6728	--	\$22.00
 <b>OEM#:783977-</b> (3) blades for 72" cut.											
<b>B1SB10797</b>	23-55/64"	5/8"	--	--	3"	.205	--	90-209	10797	--	\$22.00
<b>Jacobsen</b>											
 <b>OEM#:330721, 500904-</b> (3) blades for 42" cut.											
<b>B1SB3346</b>	14-7/8"	7/16"	1/2"	1-5/8"	2"	.155	--	91-342	3346	315-762	\$15.00
 <b>OEM#:390666-</b> (2) blades for 32" cut. (3) blades for 48" cut.											
<b>B1BC1201</b>	16-1/4"	5/8"	11/32"	1-5/8"	2-1/2"	.250	Notched	91-180	2172	310-045	\$13.00
 <b>OEM#:390666-</b> (2) blades for 32" cut. (3) blades for 48" cut.											
<b>B1PD5005</b>	16-1/4"	5/8"	--	--	2-1/2"	.250	Mulching	96-716	6296	302-616	\$21.00
 <b>OEM#:363055, 390655-</b> (2) blades for 36" cut. (3) blades for 54" cut.											
<b>B1SB6183</b>	18"	5/8"	--	--	2-1/2"	.204	Low Lift	--	6183	--	\$12.80
 <b>OEM#:390655-</b> (2) blades for 36" cut. (3) blades for 52" cut.											
<b>B1PD5008</b>	18"	5/8"	--	--	2-1/2"	.250	Mulching	96-726	6294	303-116	\$20.50
 <b>OEM#:390514-</b> (3) blades for 60" cut. Fits commercial Turfcut.											
<b>B1SB6016</b>	20-3/4"	7/16"	13/32"	2-7/8"	2-1/2"	.240	--	--	6016	--	\$18.80
 <b>OEM#:390515-</b> (3) blades for 72" cut. Fits commercial Turfcut.											
<b>B1SB3469</b>	25"	7/16"	13/32"	2-7/8"	2-1/2"	.240	--	91-352	3469	--	\$21.00

JAYDEE P/N	LENGTH	CH-D	OH DIA	C TO C	WIDTH	THICK	APPLICATION	OREGON	ROTARY	STENS	PRICE
<b>John Deere</b>											
 <b>OEM#:M41237, AM30698, AM100991-</b> (3) blades for 38" cut. For deck model 38-39-41, fits models 110, 112, 200, 300 series											
<b>B1JD5010</b>	14"	11/16"	--	--	2"	.187	--	91-385	1126	33-258	\$9.10
 <b>OEM#:M115759, M119233, M41237, AM30698-</b> (3) blades for 38" cut.											
<b>B1PD1060</b>	14"	11/16"	--	--	2-1/2"	.197	Mulching	96-608	6313	--	\$12.60
 <b>OEM#:M115759-</b> (3) blades for 38" cut shallow deck.											
<b>B1SB6193</b>	14-1/16"	11/16"	--	--	2-1/2"	.204	--	--	6193	--	\$11.90
 <b>OEM#:M127466-</b> (3) blades for 46" cut. Fits Scotts 2046 and Sabre 1646, 1846HV.											
<b>B1JD6012</b>	16"	11/16"	--	--	2-1/2"	.197	--	91-448	--	330-356	\$13.00
 <b>OEM#:M41967, AM31100-</b> (3) blades for 48" cut. Fits model 300 series, model 46-47-48 deck.											
<b>B1JD5000</b>	16"	11/16"	--	--	2"	.187	--	91-389	1127	330-266	\$10.60
 <b>OEM#:AM104488-</b> (3) blades for 48" cut. Fits old-style commercial walk-behind with flat front deck											
<b>B1UN3212</b>	16"	5/8"	--	--	2-1/2"	.197	Low Lift	91-063	6114	--	\$10.00
 <b>OEM#:AM31100, M41967-</b> (3) blades for 46" cut.											
<b>B1PD1023</b>	16"	11/16"	--	--	2-1/2"	.197	Mulching	--	6496	302-216	\$16.90
 <b>OEM#:AM31100, M41967-</b> (3) blades for 46" cut. Fits model 300 series, model 46-47-48 deck.											
<b>B1PD5023</b>	16"	11/16"	--	--	2-1/2"	.197	Mulching	96-307	6496	302-216	\$14.00
 <b>OEM#:AM104489-</b> (3) blades for 48" cut. Fits old style, commercial walk-behind, V style deck.											
<b>B1SB6222</b>	16-1/2"	5/8"	--	--	2-1/2"	.204	High Lift	--	6222	--	\$22.50
 <b>OEM#:AM104489-</b> (3) blades for 48" cut.											
<b>B1PD5006</b>	16-1/2"	5/8"	--	--	2-1/2"	.250	Mulching	96-735	6300	302-617	\$19.20
 <b>OEM#:M115495-</b> (3) blades for 48" cut. Fits 180, 185, F510, F525, F735, GS25, GS30, GS45, GS75, and F710.											
<b>B1JD5006</b>	16-5/8"	51/64"	--	--	2-1/2"	.197	--	91-381	6206	330-373	\$12.30

Replacement Blades

JAYDEE P/N	LENGTH	CH-D	OH DIA	C TO C	WIDTH	THICK	APPLICATION	OREGON	ROTARY	STENS	PRICE
<b>John Deere</b>											
 <b>OEM#:M113517-</b> (3) blades for 48" cut. Fits model F710.											
<b>B1JD5009</b>	16-5/8"	51/64"	--	--	2-1/2"	.197	Mulching	91-383	6223	330-389	\$11.90
 <b>OEM#:M113517, M115495, M76466-</b> (3) blades for 48" cut.											
<b>B1PD1024</b>	16-5/8"	51/64"	--	--	2-1/2"	.197	Mulching	96-332	6314	302-288	\$14.60
 <b>OEM#:M113517, M115495, M76466-</b> (3) blades for 48" cut.											
<b>B1PD5024</b>	16-9/16"	51/64"	--	--	2-1/2"	.197	Mulching	96-618	6314	302-288	\$17.00
 <b>OEM#:GX20250, GX20819-</b> (3) blades for 48" cut. Scotts/Sabre & Deere L and 100 series.											
<b>B1JD6014</b>	17"	11/16"	13/32"	3-3/4"	2-1/2"	.156	Standard	91-108	10634	330-619	\$10.80
 <b>OEM#:GX20250, GX20819-</b> (3) blades for 48" cut.											
<b>B1PD1044</b>	17"	11/16"	13/32"	3-3/4"	2-1/2"	.197	Mulching	92-675	--	--	\$16.00
 <b>OEM#:GX20250, GX20819-</b> (3) blades for 48" cut. Fits L and 100 series models.											
<b>B1PD5044</b>	17"	11/16"	13/32"	3-3/4"	2-1/2"	.187	Mulching	92-675	--	--	\$14.00
 <b>OEM#:GX21784, GY20852-</b> (3) blades for 48" cut. Fits LA series tractors D140, D150, D160, X140, X165, 145, 155C.											
<b>B1JD6017</b>	17"	7 lobe	--	--	2-1/2"	.156	--	92-104	11595	330-445	\$12.60
 <b>OEM#:GX21784, GX21786-</b> (3) blades for 48" cut. Fits StarLock center hold blades for LA series mowers D140, D150, D160, X140, X165, 145, 155C.											
<b>B1PD5017</b>	17"	7 lobe	--	--	2-1/2"	.197	Mulching	92-616	11596	--	\$13.80
 <b>OEM#:M127673-</b> (3) blades for 48" cut. Fits 48C decks since 1999.											
<b>B1JD1043</b>	17"	51/64"	--	--	2-1/2"	.197	Mulching	96-354	10291	--	\$11.40
 <b>OEM#:M145476-</b> (3) blades for 48" cut. Fits 48C decks since 1999.											
<b>B1JD1044</b>	17"	51/64"	--	--	2-1/2"	.197	--	90-348	--	330-369	\$11.90
 <b>OEM#:TCU14939-</b> (3) blades for 48" 7 Iron Deck.											
<b>B1JD1051</b>	17"	29/32"	--	--	3"	.197	--	--	--	--	\$19.00



JAYDEE P/N	LENGTH	CH-D	OH DIA	C TO C	WIDTH	THICK	APPLICATION	OREGON	ROTARY	STENS	PRICE
<b>John Deere</b>											
		<b>OEM#:M136185, M136194, TCU14939-</b> (3) blades for 48" cut. 7 Iron Deck.									
<b>B1PD1038</b>	17"	29/32"	--	--	2-1/2"	.197	Mulching	--	--	--	\$16.60
		<b>OEM#:M136185, M136194, TCU14939-</b> (3) blades for 48" cut. 7 Iron Deck.									
<b>B1PD5138</b>	17-3/64"	29/32"	--	--	2-1/2"	.250	Mulching	96-770	--	--	\$16.30
		<b>OEM#:M127500, M127673, M145476-</b> (3) blades for 48" cut. Fits 48C decks since 1999.									
<b>B1PD5048</b>	17-3/32"	51/64"	--	--	2-1/2"	.197	Mulching	90-477	12821	--	\$15.10
		<b>OEM#:M86209, AM39966-</b> (3) blades for 50" cut. Fits models 240-285, 300, 316, 318, 322, 332, 420 & 430.									
<b>B1JD5011</b>	17-3/16"	11/16"	--	--	2-1/2"	.197	--	91-393	6012	330-308	\$13.90
		<b>OEM#:M86209, AM39966-</b> (3) blades for 50" cut. Fits models 240-285, 300, 316, 318, 322, 332, 420 & 430.									
<b>B1PD1062</b>	17-17/64"	13/16"	--	--	2-1/2"	.197	Mulching	96-331	--	--	\$17.00
		<b>OEM#:AM104490-</b> (2) blades for 36" cut. (3) blades for 52" cut. Fits commercial walk-behind.									
<b>B1BU1300</b>	18"	5/8"	--	--	2-1/2"	.197	High Lift	91-064	6014	355-061	\$13.80
		<b>OEM#:AM104490-</b> (2) blades for 36" cut. (3) blades for 52" cut.									
<b>B1PD5008</b>	18"	5/8"	--	--	2-1/2"	.250	Mulching	96-726	6294	303-116	\$20.30
		<b>OEM#:M115496-</b> (3) blades for 54" cut.									
<b>B1JD5003</b>	18-5/8"	13/16"	--	--	2-1/2"	.197	--	91-380	6192	330-365	\$11.40
		<b>OEM#:M113518-</b> (3) blades for 54" cut. Fits model F725 and F710									
<b>B1JD5004</b>	18-5/8"	13/16"	--	--	2-1/2"	.197	Mulching	91-384	6221	330-393	\$13.70
		<b>OEM#:M122455, M122467-</b> (2) blades for 36" cut.									
<b>B1PD1043</b>	18-5/8"	1 x 1-1/8"	--	--	2-1/2"	.197	Mulching	96-393	6478	--	\$17.00
		<b>OEM#:GX21380, GY20684-</b> (3) blades for 54" cut. Fits 190C, LA150, G110.									
<b>B1JD6019</b>	18-5/8"	7 Lobe	--	--	2-3/4"	.187	--	92-103	11491	330-704	\$13.00

## Marbain® starts where other blades stop







Our patented Marbain process makes XHT and Predator blades 25% - 40% harder than typical blades that have been only heat-treated. This is what sets XHT and Predator blades apart. When the process is complete, these blades are the longest-lasting, safest, and most impact-resistant lawnmower blades available. For the next steps in the process, turn to page 285.











**5**











JAYDEE P/N	LENGTH	CH-D	OH DIA	C TO C	WIDTH	THICK	APPLICATION	OREGON	ROTARY	STENS	PRICE
------------	--------	------	--------	--------	-------	-------	-------------	--------	--------	-------	-------

### John Deere

 <b>OEM#:GX21380, GY20684-</b> (3) blades for 54" cut. Fits 190C, LA150, and G110.											
<b>B1PD5146</b>	18-5/8"	7 Lobe	--	--	2-1/2"	.250	Mulching	92-617	--	--	\$17.90
 <b>OEM#:M113518, M115496-</b> (3) blades for 54" cut.											
<b>B1PD5026</b>	18-21/32"	51/64"	--	--	2-1/2"	.197	Mulching	96-306	6315	302-256	\$17.70
 <b>OEM#:M122455-</b> (2) blades for 36" cut. Fits midsize commercial mowers, models GS25, 36.											
<b>B1SB6738</b>	18-11/16"	1 x 1-1/8"	--	--	2-1/2"	.204	--	91-077	6738	--	\$17.40
 <b>OEM#:M143520, M145516-</b> (3) blades for 54" cut C deck.											
<b>B1PD1054</b>	18-61/64"	11/16"	--	--	2-3/4"	.197	Mulching	96-719	--	--	\$18.40
 <b>OEM#:M143520, M145516-</b> (3) blades for 54" cut C deck.											
<b>B1PD5054</b>	18-29/32"	51/64"	--	--	2-1/2"	.250	Mulching	96-719	--	--	\$21.00
 <b>OEM#:M136195, TCU30316-</b> (3) blades for 54" cut.											
<b>B1PD1039</b>	19"	27/32"	--	--	3"	.197	Mulching	96-769	10072	--	\$17.20

JAYDEE P/N	LENGTH	CH-D	OH DIA	C TO C	WIDTH	THICK	APPLICATION	OREGON	ROTARY	STENS	PRICE
<b>John Deere</b>											
 <b>OEM#:M136195, TCU30316-</b> (3) blades for 54" cut.											
<b>B1PD5039</b>	19"	29/32"	--	--	2-1/2"	.250	Mulching	396-769	10072	--	\$17.80
 <b>OEM#:M144652-</b> (3) blades for 54" cut.											
<b>B1JD1038</b>	19"	7/8"	--	--	3"	.250	High Lift	92-118	--	--	\$18.90
 <b>OEM#:M136195-</b> (3) blades for 54" cut. Fits 7 Iron deck and Z trak M653, M655, F620, F680, F687, 737, 757.											
<b>B1JD1039</b>	19"	7/8"	--	--	2-1/2"	.250	--	91-138	6480	330-595	\$17.80
 <b>OEM#:M135334-</b> (3) blades for 54" cut. Fits 7 Iron deck and Z trak M653, M655, F620, F680, F687, 737, 757.											
<b>B1JD1042</b>	19"	7/8"	--	--	2-1/2"	.250	Mulching	--	--	--	\$16.70
 <b>OEM#: M143520-</b> (3) blades for 54" cut. Fits 54C decks.											
<b>B1JD1052</b>	19"	51/64"	--	--	2-3/4"	.187	--	90-354	10292	330-489	\$12.90
 <b>OEM#:AM100991, AM137326, M83459-</b> (2) blades for 38" cut.											
<b>B1JD5016</b>	19-1/2"	7 Lobe	--	--	3"	.197	High Lift	91-398	12562	330-316	\$12.80
 <b>OEM#:AM137325, M112991, M154158-</b> (2) blades for 38" cut.											
<b>B1JD5015</b>	19-1/2"	7 Lobe	--	--	2-1/2"	.197	Mulching	91-403	6186	330-736	\$13.00
 <b>OEM#:M153118, M84472-</b> (2) blades for 38" cut.											
<b>B1JD5105</b>	19-1/2"	7 Lobe	--	--	3"	.197	Medium Lift	91-400	6737	330-724	\$12.60
 <b>OEM#:AM100946, M82408-</b> (2) blades for 38" cut.											
<b>B1JD5101</b>	19-1/2"	7 Lobe	--	--	2-1/2"	.197	Low Lift	91-392	1127	330-290	\$11.80
 <b>OEM#:AM100946, AM100991, M112991, M154159, M84208, M83459, M84472</b> (2) blades for 38" cut.											
<b>B1PD5125</b>	19-1/2"	7 Lobe	--	--	2-1/2"	.197	Mulching	96-309	6421	--	\$13.10
 <b>OEM#:M141785, M87622, AM100538-</b> (3) blades for 60" cut. Fits models 260, 261, 381, 420, and 430.											
<b>B1JD5008</b>	20-1/2"	29/32"	--	--	2-1/2"	.312	--	91-394	6253	330-357	\$21.00











Replacement Blades

JAYDEE P/N	LENGTH	CH-D	OH DIA	C TO C	WIDTH	THICK	APPLICATION	OREGON	ROTARY	STENS	PRICE
<b>John Deere</b>											
 <b>OEM#:AM100538, M87622-</b> (3) blades for 60" cut.											
<b>B1PD1063</b>	20-1/2"	29/32"	--	--	3"	.197	Mulching	96-734	--	--	\$22.00
 <b>OEM#: AM100538, M87622-</b> (3) blades for 60" cut.											
<b>B1PD5063</b>	20-1/2"	29/32"	--	--	2-1/2"	.250	Mulching	96-734	--	--	\$24.40
 <b>OEM#:AM35557, M48452, M112847-</b> (3) blades for 60" cut. Fits model 400 and WH-D250.											
<b>B1SB2120</b>	20-1/2"	25/32"	--	--	2"	.187	--	91-391	2120	330-282	\$11.70
<b>OEM#: M125413, M112972, M115453, M112738-</b> (1) blade for 21" cut. Aluminum deck push mowers. Fits models GX14SB, GX14BE, 14PT, 14ST Silver, JA60, JA62, JA65, Saber 14PS, and 14SS											
<b>B1JD5007</b>	20-7/8"	29/32"	13/32"	3-11/16"	2-3/4"	.134	Mulching	91-443	6122	330-429	\$13.50
 <b>OEM#: M125413, M112738, M112972, M115453-</b> (1) blade for 21" cut.											
<b>B1PD1064</b>	20-7/8"	29/32"	13/32"	3-11/16"	2-5/8"	.197	Mulching	90-962	--	--	\$21.80
 <b>OEM#: M128485, M144196, TCU15881-</b> (3) blades for 60" cut. Fits 7 Iron Deck, Z Trak, F620, M665, F680 models. Also fits 4200, 4300 and 4400 compact utility tractors											
<b>B1JD1040</b>	21"	7/8"	--	--	2-1/2"	.312	Medium Lift	91-078	6479	330-591	\$22.30
 <b>OEM#: M128485, M144196, TCU15881-</b> (3) blades for 60" cut.											
<b>B1JD1092</b>	21"	29/32"	--	--	2-1/2"	.250	High Lift	91-078	--	330-501	\$21.00
 <b>OEM#: M128485, M144196, TCU15881-</b> (3) blades for 60" cut. 7 Iron deck.											
<b>B1PD1041</b>	21"	29/32"	--	--	3"	.250	Mulching	--	--	--	\$18.00
 <b>OEM#: M128485, M144196, TCU15881-</b> (3) blades for 60" cut. 7 Iron deck.											
<b>B1PD5041</b>	21"	29/32"	--	--	2-1/2"	.250	Mulching	96-730	10073	--	\$18.20

**XHT quality in a mulching blade**











Our Predator blades are made with the same hardened steel and heat-treated with the same proprietary process as our XHT blades. That makes them 25% - 40% harder than similar looking mulching blades. Lots of blades have teeth, only Predators have XHT.













JAYDEE P/N	LENGTH	CH-D	OH DIA	C TO C	WIDTH	THICK	APPLICATION	OREGON	ROTARY	STENS	PRICE
<b>John Deere</b>											
 <b>OEM#: GC00344-</b> (1) blade for 21" cut.											
<b>B1JD1045</b>	21"	13/16"	15/32"	2"	2-1/2"	.197	Mulching	--	10458	330-770	\$17.80
 <b>OEM#: M131958-</b> (3) blades for 60" cut.											
<b>B1JD1090</b>	21"	29/32"	--	--	2-1/2"	.250	Mulching	--	--	330-587	\$18.70
 <b>OEM#: GX20249-</b> (2) blades for 42" cut. Fits L100 and 100 series models.											
<b>B1PD1045</b>	21-3/64"	11/16"	13/32"	3-3/4"	2-3/4"	.197	Mulching	96-365	--	--	\$16.00
 <b>OEM#: AM137327, AM141032, M154061-</b> (2) blades for 42" cut. Side Discharge.											
<b>B1JD1091</b>	21-1/4"	7 Lobe	--	--	2-3/4"	.197	--	92-110	12380	330-728	\$15.90
 <b>OEM#: GX20249-</b> (2) blades for 42" cut. Fits L100 and 100 series models.											
<b>B1PD5045</b>	21-3/8"	11/16"	13/32"	3-3/4"	2-1/2"	.187	Mulching	92-676	--	--	\$15.00
 <b>OEM#: M148613-</b> (2) blades for 42" cut. Fits GT225, GT235, GT235E, GT245, GX325, GX335, GX345, GX355, LX255, LX266, LX279, and LX288 models with 42C decks.											
<b>B1JD1046</b>	21-3/8"	51/64"	--	--	2-1/2"	.197	--	91-446	10074	330-453	\$13.50
 <b>OEM#: GX20249-</b> (2) blades for 42" cut. Fits Scotts/Sabre & Deere L100 and 100 models.											
<b>B1JD6015</b>	21-1/2"	11/16"	13/32"	3-3/4"	2-1/2"	.156	--	91-139	--	330-615	\$10.20
 <b>OEM#: M139975, M139977, M148613, M159046-</b> (2) blades for 42" cut. Fits GT255, GT235, GT235E, GT245, GX325, GX335, GX345, GX355, LX255, LX266, LX279, and LX288 models with 42C decks.											
<b>B1PD1042</b>	21-5/16"	29/32"	--	--	2-3/4"	.197	Mulching	96-365	--	--	\$16.50
 <b>OEM #: M139975, M139977, M148613, M159046</b> - (2) blades for 42" cut. Fits GT255, GT235, GT235E, GT245, GX325, GX335, GX345, GX355, LX255, LX266, LX279, and LX288 models with 42C decks.											
<b>B1PD5042</b>	21-5/16"	13/16"	--	--	2-1/2"	.197	Mulching	91-604	--	--	\$15.40
 <b>OEM#: M139802</b> - (2) blades for 42" cut. Fits Scotts and Sabre models.											
<b>B1JD6013</b>	21-15/32"	11/16"	--	--	2-1/4"	.165	Mulching	91-449	9959	330-377	\$14.80
 <b>OEM#: GX22151</b> - (2) blades for 42" cut. Fits 102, 115, 125, 135, D100, D110, D120 D130, LA100, LA105, LA110, LA115, LA120, LA125, LA135, X110, X120, X125, and X145 model tractors with StarLock Center Hole.											
<b>B1PD5016</b>	21-3/8"	7 lobe	--	--	2-1/2"	.197	Mulching	92-615	11594	--	\$14.80



Replacement Blades

JAYDEE P/N	LENGTH	CH-D	OH DIA	CTO C	WIDTH	THICK	APPLICATION	OREGON	ROTARY	STENS	PRICE
<b>John Deere</b>											
		<b>OEM#: GX22151</b> - (2) blades for 42" cut. Fits 102, 115, 125, 135, D100, D110, D120, D130, LA100, LA105, LA110, LA115, LA120, LA125, LA135, X110, X120, X125, and X145 model tractors with StarLock Center Hole.									
<b>B1JD6016</b>	21-1/2"	7 lobe	--	--	2-1/2"	.156	--	92-106	11593	330-441	\$13.60
		<b>OEM#: M143504, M145719</b> - (3) blades for 62" cut C Deck									
<b>B1PD1068</b>	21-5/8"	51/64"	--	--	2-1/2"	.197	Mulching	96-771	--	--	\$20.80
		<b>OEM#: M143504, M145719</b> - (3) blades for 62" cut C Deck									
<b>B1PD5068</b>	21-5/8"	51/64"	--	--	2-1/2"	.250	Mulching	96-771	--	--	\$22.80
		<b>OEM#: M144935, TCU51118</b> - (7) blades for 1600, 1600 Turbo, 1600 Turbo Series II and 1620 wide area mower									
<b>B1JD1050</b>	21-29/32"	29/32"	--	--	2-1/2"	.250	Mulching	91-488	--	--	\$11.50
		<b>OEM#: M143504-</b> (3) blades for 62" cut. Fits 62C Decks									
<b>B1JD1049</b>	21-3/4"	51/64"	--	--	2-1/2"	.250	--	90-309	--	--	\$16.10
		<b>OEM#: M80783, AM38314, AM102401, M83363, M141786</b> (3) Blades for 72" cut									
<b>B1JD1047</b>	24-15/16"	29/32"	--	--	2-1/2"	.312	--	91-395	6255	330-688	\$24.20
		<b>OEM#: AM102402, AM38314, M80783, M141786, M83363</b> (3) Blades for 72" Cut									
<b>B1PD1065</b>	24-15/16"	29/32"	--	--	3"	.197	Mulching	90-775	--	--	\$24.20
		<b>OEM#: M142514, TCU15882</b> - (3) blades for 72" cut. 7 Iron deck									
<b>B1PD5018</b>	25"	29/32"	--	--	2-1/2"	.250	Mulching	92-414	--	--	\$22.90
		<b>OEM#: TCU15882</b> - (3) blades for 72" cut. 7 Iron deck									
<b>B1JD6018</b>	25"	29/32"	--	--	3"	.250	--	92-114	12643	330-505	\$23.40
		<b>OEM#: M118958-</b> (1) blade for 30" cut. Fits models 108, 111, 130, 160, 165, RX73, RX75, RX95, SX75, STX30, GX70, GX75, GX95, GX85, SX85, rear engine mowers.									
<b>B1SB6329</b>	29-1/2"	11/16"	--	--	2-1/2"	.204	Mulching	--	6329	330-336	\$22.20
		<b>OEM#: AM101538, M89454, AM36407-</b> (1) blade for 30" cut. Formed center for washer.									
<b>B1SB6328</b>	29-1/2"	11/16"	--	--	2-1/2"	.204	--	91-399	6328	--	\$22.60









JAYDEE P/N	LENGTH	CH-D	OH DIA	C TO C	WIDTH	THICK	APPLICATION	OREGON	ROTARY	STENS	PRICE
<b>John Deere</b>											
 <b>OEM#: AM101539, M89455-</b> (1) blade for 30" cut, with grass catchers. (1) blade for riders with formed centers											
<b>B1SB6327</b>	29-9/16"	11/16"	--	--	2-1/2"	.203	High Lift	91-402	6327	330-340	\$21.30
 <b>OEM#: AM36407-</b> (1) blade for 30" cut. Older model rear engine rider.											
<b>B1SB847</b>	30-1/16"	11/16"	--	--	2-1/2"	.204	--	--	847	330-324	\$35.00
<b>Kubota</b>											
 <b>OEM#: 70713-34330-</b> (3) blades for 40" cut. Fits model RC40-42 and RC40-42R.											
<b>B1SB3385</b>	14-5/8"	11/16"	--	--	2"	.204	--	--	3385	--	\$13.50
 <b>OEM#: 70712-34330-</b> (3) blades for 44" cut. Fits model RC44-GE and RC44-LTF.											
<b>B1SB3386</b>	15-5/16"	11/16"	11/32"	1-1/2"	2"	.204	--	91-430	3386	330-555	\$11.20
 <b>OEM#: 70721-34330, 76500-70721-</b> (3) blades for 48" cut. Fits models MR4800, RC48, RC486.											
<b>B1SB3387</b>	16-5/8"	11/16"	11/32"	1-1/2"	2"	.204	--	--	3387	--	\$12.40
 <b>OEM#: 76500-34330-</b> (3) blades for 48" cut. Fits models RC62, 72 and 82, Deck #RC48-62H, RC48-62AF and RC48G.											
<b>B1KU1020</b>	16-5/8"	3/4"	--	--	2-7/16"	.197	--	91-433	6208	330-005	\$11.20
 <b>OEM#:76529-34330-</b> (3) blades for 54" cut. Fits models RC54-F19, RC54-FZ21, RC54-G20R, RC54-24B, and RC54-B.											
<b>B1KU1022</b>	18-11/16"	1-1/8"	--	--	2-1/2"	.250	--	91-436	6265	330-542	\$13.00
 <b>OEM#: 70724-34334A-</b> (3) blades for 60" cut. Fits models RC60-24BR, RC60-71HR, RC60-72HR, RC60-72HRII, RC60-BRII, RC60-STR, RC82HR, and RC82HR2.											
<b>B1VLH4120</b>	20-5/16"	11/16"	--	--	2"		Offset	--	--	--	\$24.90
 <b>OEM#: 70722-34330-</b> (3) blades for 60" cut. Fits models MR6000, RCB60-I/E/AE, RC60-71H, RC60-72/A, RC60-27											
<b>B1SB3388</b>	20-7/16"	11/16"	--	--	2"	.203	--	91-429	3388	--	\$13.00
 <b>OEM#: 76540-34330, 76540-34330A, 76540-34333, 76540-34333A-</b> (2) blades for 40" cut. (3) blades for 60" cut. Fits models RC60-20, RC60-F20, RC60-25.											
<b>B1SB3389</b>	20-15/32"	15/16"	--	--	2-1/4"	.240	--	91-437	3389	--	\$16.50
 <b>OEM#: K5647-34340-</b> (3) blades for 60" cut.											
<b>B1KU1024</b>	20-1/2"	1-1/8"	--	--	2-1/2"	.250	--	92-049	--	--	\$14.90



Replacement Blades

JAYDEE P/N	LENGTH	CH-D	OH DIA	C TO C	WIDTH	THICK	APPLICATION	OREGON	ROTARY	STENS	PRICE
------------	--------	------	--------	--------	-------	-------	-------------	--------	--------	-------	-------

**Kubota**









 <b>OEM#: K5647-34340-</b> (3) blades for 60" cut.											
<b>B1PD5148</b>	20-1/2"	1-1/8"	--	--	2-1/2"	.250	Mulching	--	--	--	\$18.80
 <b>OEM#: 70000-00606, 75000-25001, 76539-34330-</b> (3) blades for 60" cut. Fits tractor models B2150, B1750, B7100HSD, B1500, FZ2100, FZ2400, G1900, G2000, with deck models RC60-21B, RC60-71B, 60B, 60F221 and 60GO.											
<b>B1KU1021</b>	20-9/16"	1-1/8"	--	--	2-1/2"	.250	Heavy-Duty	91-438	6209	330-552	\$17.00
 <b>OEM#: 65621-37212-</b> (1) blade for 21" self-propelled walk-behind electric start 5 HP model W50021SCE.											
<b>B1SB6173</b>	20-11/16"	3/4"	9/16"	3-17/32"	2-1/4"	.150	--	91-417	6173	--	\$12.20
 <b>OEM#: K5677-34340-</b> (3) blades for 72" cut.											
<b>B1KU1025</b>	24-1/2"	1-1/8"	--	--	2-1/2"	.250	--	92-116	--	--	\$16.90
 <b>OEM#: K5677-34340-</b> (3) blades for 72" cut.											
<b>B1PD5147</b>	24-1/2"	1-1/8"	--	--	2-1/2"	.250	Mulching	96-372	--	--	\$20.40
 <b>OEM#: 76550-34330-</b> (3) blades for 72" cut. Fits tractor models L2850, L2550, F2100F and F2400 with deck models RC72-78, RC72-F25, RC72-F20 and RC72-F24.											
<b>B1SB6207</b>	24-9/16"	15/16"	--	--	2-1/2"	.240	--	--	6207	--	\$17.50

**Lawn Boy/Gilson**

 <b>OEM#: 612079, 682909, 611289-</b> (1) blade for 19" cut Scamp mowers.											
<b>B1SB848</b>	18-15/16"	5/8"	17/32"	2-9/16"	3"	.134	--	92-010	848	330-837	\$16.00
 <b>OEM#: 210505, 705658-</b> (2) blades for 38" cut.											
<b>B1SB2033</b>	19-1/2"	1-1/8"	25/64"	3-1/4"	2-1/2"	.134	High Lift	--	2033	--	\$12.40
 <b>OEM#: 603703, 612543-03-</b> (1) blade for 21" cut. Fits models from 1961 to 1980.											
<b>B1SB1057</b>	20-3/4"	5/8"	--	--	2-1/2"	.134	--	--	1057	--	\$20.00
 <b>OEM#: 612543, 683682, 611240, 608094-</b> (1) blade for 21" Tri-Cut. Use with our BBC.											
<b>B1LB2300</b>	20-7/8"	5/8"	17/32"	2-9/16"	3"	.134	--	92-011	849	330-845	\$13.50











**Lesco**

 <b>OEM#: 021871, 050111-</b> (2) blades for 32" cut. (3) blades for 48" cut.											
<b>B1SC2800</b>	16-1/2"	5/8"	--	--	2-1/2"	.197	Notched	91-620	3403	340-109	\$12.60

JAYDEE P/N	LENGTH	CH-D	OH DIA	C TO C	WIDTH	THICK	APPLICATION	OREGON	ROTARY	STENS	PRICE
<b>Lesco</b>											
 <b>OEM#: 021871, 050111-</b> (2) blades for 32" cut. (3) blades for 48" cut.											
<b>B1PD5006</b>	16-1/2"	5/8"	--	--	2-1/2"	.250	Mulching	96-735	6300	302-617	\$19.80
 <b>OEM#: 050111-</b> (3) blades for 48" cut.											
<b>B1SC2804</b>	16-1/2"	5/8"	--	--	3"	.197	High Lift	91-621	6009	340-113	\$18.00
 <b>OEM#: 050125-</b> (2) blades for 36" cut. (3) blades for 52" cut.											
<b>B1SC2801</b>	18"	5/8"	--	--	2-1/2"	.197	Notched	91-622	3404	340-158	\$13.00
 <b>OEM#: 050125, 050140 -</b> (2) blades for 36" cut. (3) blades for 52" cut.											
<b>B1PD5008</b>	18"	5/8"	--	--	2-1/2"	.250	Mulching	96-726	6294	302-618	\$21.00
 <b>OEM#: 050140, 482467-</b> (2) blades for 36" cut. (3) blades for 52" cut.											
<b>B1SC2803</b>	18"	5/8"	--	--	3"	.197	Notched	91-623	3442	340-121	\$18.90
 <b>OEM#: 050156, 482129-</b> (2) blades for 40" cut. (3) blades for 60" cut.											
<b>B1SB6008</b>	20"	5/8"	--	--	2-1/2"	.204	--	91-624	6008	--	\$29.90
 <b>OEM#: 050170-</b> (3) blades for 61" cut.											
<b>B1SC2802</b>	21"	5/8"	--	--	2-1/2"	.197	Notched	91-626	3434	302-621	\$14.00
 <b>OEM#: 050170-</b> (3) blades for 61" cut. Fits Commercial Pro Cut.											
<b>B1EM1803</b>	21"	5/8"	--	--	2-1/2"	.250	Low Lift	--	--	303-188	\$16.00

Grinders		
 <p><b>Commercial Blade Grinder</b> 1 HP commercial grinder designed to sharpen any type of blade on the market. Comes with a 12" x 1" x 7/8" premium-grade ceramic wheel.</p> <p><b>B1AC1012</b>      \$1210.00</p>	 <p><b>Commercial Blade Grinder</b> 3/4 HP commercial grinder designed to sharpen commercial and consumer blades. Comes with a 10" x 1" x 3/4" premium-grade ceramic wheel.</p> <p><b>B1AC3410</b>      \$837.00</p>	 <p><b>Standard Blade Grinder</b> 1/2 HP standard grinder is designed to be the most affordable grinder available. Comes with a 8" x 1" x 5/8" ruby wheel.</p> <p><b>B1SB1735</b>      \$560.00</p>







Replacement Blades

JAYDEE P/N	LENGTH	CH-D	OH DIA	C TO C	WIDTH	THICK	APPLICATION	OREGON	ROTARY	STENS	PRICE
<b>Lesco</b>											
 <b>OEM#: 050170-</b> (3) blades for 61" cut.											
<b>B1PD5010</b>	21"	5/8"	--	--	2-1/2"	.250	Mulching	96-727	6299	302-621	\$25.00
<b>Maxim</b>											
 <b>OEM#: 145107-</b> (1) blade for 30" cut rear engine rider.											
<b>B1AR1025</b>	30"	3/4"	25/64"	11"	2-3/4"	.187	--	91-012	2137	305-839	\$30.00
<b>MTD</b>											
 <b>OEM#: 942-0252, 742-0252</b> - (1) B1SB3408 and (2) B1SB3407 for 44" cut. Fits model 931.											
<b>B1SB3408</b>	6-3/8"	3/8"	--	--	1-1/2"	.095	--	--	3408	--	\$15.00
 <b>OEM#: 742-0539, 942-0539-</b> (2) blades for use with B1MA2408. or B1AM2407 Mulching Cross Blade.											
<b>B1SB6128</b>	12-3/8"	1-1/2"	7/16"	2-1/2"	3-3/4"	.117	Mulching	--	6128	--	\$16.20
 <b>OEM#: 742-0543, 942-0543-</b> (1) B1MA2412 and (2) B1MA2411 for 46" cut.											
<b>B1MA2412</b>	14-13/16"	"H" Pattern	5/16"	2-1/2"	3"	.125	--	98-056	1022	335-533	\$10.60
 <b>OEM#: 742-04124, 742-0612, 942-0612-</b> (1) B1MA2431 and (2) B1MA2402 for 46" cut.											
<b>B1MA2431</b>	14-7/8"	"H" pattern	5/16"	2-1/2"	2-1/2"	.156	--	98-061	1030	335-695	\$9.90
 <b>OEM#: 742-0645, 942-0645-</b> (1) B1MA2424 and (2) B1MA2425 for 46" cut.											
<b>B1MA2424</b>	14-13/16"	"H" pattern	21/64"	2-1/2"	3"	.125	Mulching	98-069	1038	335-723	\$12.60
 <b>OEM#: 942-0129, 742-0129-</b> (3) blades for 42" cut, side discharge.											
<b>B1MA2405</b>	14-3/4"	3/8"	5/16"	2-1/2"	2"	.156	--	--	999	335-539	\$9.90
 <b>OEM#: 742-0486, 942-0486-</b> (1) B1SB6019 and (2) B1MA2401 for 46" cut. Fits Deep Deck 800 series.											
<b>B1SB6019</b>	14-3/4"	13/32"	5/16"	2-1/2"	3"	.150	--	--	6019	335-125	\$16.00
 <b>OEM#: 742-0644, 942-0644</b> - (2) B1AM2425 and (1) B1AM2424 for 46" cut.											
<b>B1MA2425</b>	16-1/4"	"H" pattern	21/64"	2-1/2"	3"	.125	Mulching	98-054	1037	335-719	\$12.00

**XHT and Predator quality from start to finish**











6  
Once our blades have gone through all the steps needed in order to transform them from steel to XHT, we continue our pursuit of quality. Before the blades are painted, they are tested one last time to make sure that they meet our standards. This blade is about to be tested to make sure that it has the appropriate hardness. The finishing touches are added on page 303.













JAYDEE P/N	LENGTH	CH-D	OH DIA	C TO C	WIDTH	THICK	APPLICATION	OREGON	ROTARY	STENS	PRICE
<b>MTD</b>											
 <b>OEM#:742-04125, 742-0611, 942-6011-</b> (2) B1MA2402 and (1) B1MA2431 for 46" cut.											
<b>B1MA2402</b>	16-1/4"	"H" pattern	5/16"	2-1/2"	2-1/2"	.156	--	98-063	1029	335-691	\$9.10
 <b>OEM#: 742-0542, 942-0542-</b> (2) B1MA2411 and (1) B1MA2412 for 46" cut.											
<b>B1MA2411</b>	16-1/4"	"H" pattern	5/16"	2-1/2"	3"	.125	--	98-057	1021	335-525	\$11.00
 <b>OEM#: 742-0477, 742-0480, 742-0487, 942-0477, 942-0480, 942-0487-</b> (2) B1MA2401 and (1) B1SB6019 for 46" cut.											
<b>B1MA2401</b>	16-1/4"	13/32"	5/16"	2-1/2"	3"	.156	--	98-487	6003	335-117	\$13.00
 <b>OEM#: 742-0171, 742-0171B, 942-0171B -</b> (3) blades for 50" cut.											
<b>B1SB3356</b>	17-1/4"	3/8"	5/16"	2-1/2"	2-1/2"	.204	--	98-037	3356	335-653	\$19.90
 <b>OEM#: 942-0120, 742-0120, 942-0120B-</b> (2) blades for 32" cut. Side discharge. Fits models 440, 445, 455, 460, 462, 465, 466, 470, 472, 475, 480, 485, 488, 620, 621, 752, 138-460A, 138-462A, 138-465A, W7-BG-462B.											
<b>B1SB997</b>	17-1/4"	3/8"	5/16"	2-1/2"	2"	.150	--	--	997	--	\$18.70
 <b>OEM#: 742-0623, 942-0623-</b> (3) blades for 50" cut.											
<b>B1MA2432</b>	17-5/16"	"H" pattern	5/16"	2-1/2"	2-1/2"	.197	--	98-064-1	1034	335-650	\$12.80
 <b>OEM#:191-0917-</b> (2) blades for 33" wide cut Troy Bilt units.											
<b>B1MA2422</b>	17-7/8"	3/4 x 9/16"	--	--	2"	.250	--	--	--	310-540	\$13.00













Replacement Blades









JAYDEE P/N	LENGTH	CH-D	OH DIA	C TO C	WIDTH	THICK	APPLICATION	OREGON	ROTARY	STENS	PRICE
<b>MTD</b>											
		<b>OEM#: 742-04056, 742-04053A-</b> (3) blades for 50" cut.									
<b>B1CC1428</b>	17.9"	"H" pattern	--	--	2-1/2"	.187	Heavy-duty	--	11507	--	\$11.20
		<b>OEM#: 742-0121B, 942-0121B, 742-0121, 07545, 07713-</b> (2) blades for 36" cut. Also fits 18" push/side discharge.									
<b>B1SB1014</b>	18"	3/8"	5/16"	2-1/2"	2"	.150	--	--	1014	335-562	\$19.60
		<b>OEM#: 742-0738, 942-0738-</b> (1) blade for 18" cut walk-behind. Fits bow tie center hole.									
<b>B1SB6448</b>	18"	59/64 x 11/16"	5/16"	2-1/2"	2-1/4"	.134	Mulching	98-065	6448	--	\$14.00
		<b>OEM#: 742-0496, 942-0496-</b> (2) blades for 36" cut.									
<b>B1MA2410</b>	18-3/16"	13/32"	5/16"	2-1/2"	3"	.156	High Lift	98-496	6143	335-170	\$13.60
		<b>OEM#: 742-0677, 942-0677B -</b> (3) blades for 54" cut. Fits 14AR808K131, 14AZ814K401 and 14AR814K401.									
<b>B1CC1427</b>	18-1/2"	"H" pattern	5/16"	2-1/2"	3"	.156	--	98-072	11719	335-855	\$14.70
		<b>OEM#: 742-0122A, 942-0122A-</b> (2) blades for 38" cut. Fits models 476, 487, 490, 493, 494, 495, 496, 497, 497F, 497P, 498, 628, 720, 760, 765S/D, 138-495A, 138-497A, W7-BG-497B, etc.									
<b>B1MA2400</b>	19"	3/8"	5/16"	2-1/2"	2"	.156	--	98-019	1015	335-570	\$12.60
		<b>OEM#: 742-0610, 942-0610-</b> (2) blades for 38" cut.									
<b>B1MA2413</b>	19-5/16"	"H" pattern	5/16"	2-1/2"	3"	.156	Mulching	98-058	1026	335-624	\$13.00
		<b>OEM#: 742-0610, 742-0654, 942-0610, 942-0654-</b> (2) blades for 38" cut. Use in place of B1MA2413 for non-mulching.									
<b>B1MA2415</b>	19-5/16"	"H" pattern	5/16"	2-1/2"	3"	.156	--	98-052	1024	335-586	\$13.00
		<b>OEM#: 742-0537, 942-0537-</b> (2) blades for 38" cut. Use with our B1SB6128 cross blade for mulching									
<b>B1MA2407</b>	19-5/16"	13/32"	7/16"	2-1/2"	3"	.156	--	98-537	6126	335-790	\$14.00
		<b>OEM#: 742-0322, 742-0323, 742-0472, 942-0472 942-0743-</b> (1) B1MA2427 and (1) B1MA2404 for 38" cut.									
<b>B1MA2427</b>	19-3/8"	13/32"	5/16"	2-1/2"	2"	.156	--	98-043	3471	--	\$14.80
		<b>OEM#: 742-0473A, 942-0473A-</b> (1) B1MA2427 and (1) B1MA2404 for 38" cut.									
<b>B1MA2404</b>	19-3/8"	13/32"	5/16"	2-1/2"	3"	.156	--	98-044	6006	335-877	\$14.00



JAYDEE P/N	LENGTH	CH-D	OH DIA	C TO C	WIDTH	THICK	APPLICATION	OREGON	ROTARY	STENS	PRICE
<b>MTD</b>											
 OEM#:742-0520, 742-0517, 742-0620, 942-0620- (1) blade for 20" cut walk-behind											
B1MA2429	20"	13/16"	3/8"	2-1/2"	2"	.156	--	98-047	6005	335-943	\$11.00
 OEM#: 742-0640, 942-0640 - (1) blade for 20" walk-behind.											
B1MA2423	20"	59/64 x 11/16"	5/16"	2-1/2"	2-1/4"	.125	High Lift	98-068	6439	335-665	\$11.00
 OEM#: 742-0740, 942-0740- (1) blade for 20" cut walk-behind.											
B1MA2430	20"	59/64 x 11/16"	5/16"	2-1/2"	2-1/4"	.125	Mulching	98-066	6438	335-715	\$11.40
 OEM#: 742-0123, 742-0128, 942-0123B- (1) blade for 20" cut walk-behind.											
B1SB1016	20"	3/8"	5/16"	2-1/2"	2"	.150	--	98-020	1016	335-588	\$21.70
 OEM#: 742-0720, 942-0720- (1) blade for 20" cut.											
B1MA2419	20"	13/16"	3/8"	2-1/2"	2-1/2"	.125	Mulching	98-004	6457	335-592	\$13.00
 OEM#:742-0500, 942-0500- (1) blade for 20" cut walk-behind.											
B1SB6140	20"	13/16"	3/8"	2-1/2"	2-1/4"	.125	Mulching	98-010	6140	--	\$16.00
 OEM#: 742-0621, 742-0521, 942-0621- (1) blade for 21" cut rear bagger.											
B1MA2428	20-15/16"	13/16"	3/8"	2-1/2"	2"	.156	--	98-002	6096	335-083	\$10.20
 OEM#: 742-0124, 942-0124- (1) blade for 21" cut push mower.											
B1SB1017	21"	3/8"	5/16"	2-1/2"	2"	.150	--	98-021	1017	335-596	\$26.00
 OEM#: 742-0306, 742-0621, 942-0306, 942-0621A- (1) blade for 21" cut self propelled bagger.											
B1SB6042	21"	13/16"	3/8"	2-1/2"	2-1/2"	.187	--	--	6042	--	\$16.00
 OEM #: 742-0721, 742-0563, 942-0721 - (1) blade for 21" cut.											
B1MA2409	21"	27/32"	3/8"	2-1/2"	2-1/4"	.125	Mulching	98-007	6139	335-814	\$12.20
 OEM#: 942-0641- (1) blade for 21" cut walk-behind..											
B1MA2433	21"	5/16" x 11/16"	5/16"	2-1/2"	2-1/4"	.134	High Lift	--	6450	335-677	\$10.20

Replacement Blades

JAYDEE P/N	LENGTH	CH-D	OH DIA	C TO C	WIDTH	THICK	APPLICATION	OREGON	ROTARY	STENS	PRICE
<b>MTD</b>											
		<b>OEM#: 742-0741, 942-0741-</b> (1) blade for 21" cut walk-behind.									
<b>B1MA2417</b>	21"	59/64 x 11/16"	5/16"	2-1/2"	2-1/4"	.125	Mulching	98-049	6423	335-214	\$10.40
		<b>OEM#: 742-0499, 942-0499-</b> (2) blades for 42" cut. Deep deck.									
<b>B1MA2406</b>	21-3/16"	13/32"	5/16"	2-1/2"	3"	.156	--	98-499	6028	335-067	\$14.90
		<b>OEM#: 742-0499, 742-0499A, 942-0499A, 742-0503, 942-0503-</b> (2) blades for 42" cut.									
<b>B1PD1028</b>	21-3/16"	13/32"	5/16"	2-1/2"	3"	.197	Mulching	--	6295	--	\$14.40
		<b>OEM#: 742-0538, 942-0538-</b> (2) blades for 42" cut. Use with out B1SB6128 cross blade for mulching									
<b>B1MA2408</b>	21-3/16"	13/32"	7/16"	2-1/2"	3"	.156	Mulching	98-538	6127	335-782	\$13.10
		<b>OEM#: 742-0616, 942-0616-</b> (2) blades for 42" cut. Mulching hump design.									
<b>B1PD1095</b>	21-3/16"	"H" pattern	5/16"	2-1/2"	3"	.197	Mulching	--	11233	--	\$13.80
		<b>OEM#: 742-0616, 942-0616-</b> (2) blades for 42" cut.									
<b>B1MA2414</b>	21-3/16"	"H" pattern	5/16"	2-1/2"	3"	.156	Mulching	98-059	1032	335-707	\$14.70
		<b>OEM#: 742-0616, 742-0656, 942-0616, 942-0656 -</b> (2) blades for 42" cut.									
<b>B1MA2416</b>	21-3/16"	"H" pattern	5/16"	2-1/2"	3"	.156	--	98-153	1031	335-711	\$13.80
		<b>OEM#: 742-04312, 942-04312-</b> (2) blades for 42" cut. 2-in-1 blade for either discharging or bagging.									
<b>B1CC1426</b>	21-1/4"	"H" pattern	5/16"	2-1/2"	2-1/2"	.156	2-in-1	--	--	--	\$14.50
		<b>OEM#: 742-0722, 942-0722-</b> (1) blade for 22" cut walk-behind.									
<b>B1MA2420</b>	21-15/16"	13/16"	3/8"	2-1/2"	2-1/4"	.125	Mulching	98-005	6212	335-628	\$11.80
		<b>OEM#: 742-0642, 942-0642-</b> (1) blade for 22" cut walk-behind.									
<b>B1MA2418</b>	22"	9/64 x 11/16"	5/16"	2-1/2"	2-1/4"	.125	--	98-050	6425	335-632	\$11.80
		<b>OEM#: 742-0125, 942-0125, 742-0125B, 942-0125B-</b> (1) blade for 22" cut side discharge, (2) blades for 42" cut.									
<b>B1SB1018</b>	22"	3/8"	5/16"	2-1/2"	2"	.150	--	98-022	1018	335-604	\$26.00











JAYDEE P/N	LENGTH	CH-D	OH DIA	C TO C	WIDTH	THICK	APPLICATION	OREGON	ROTARY	STENS	PRICE
<b>MTD</b>											
		<b>OEM#: 742-0522, 742-0622, 942-0622-</b> (1) blade for 22" cut self-propelled walk-behind.									
<b>B1MA2403</b>	22"	13/16"	3/8"	2-1/2"	2"	.156	--	98-048	6004	335-669	\$12.00
		<b>OEM#: 742-0295, 942-0295-</b> (1) B1SB3408 and (2) B1SB3407 for 44" cut.									
<b>B1SB3407</b>	22"	13/32"	5/16"	2-1/2"	2"	.187	--	98-038	3407	335-737	\$22.90
		<b>OEM#: 742-0742, 942-0742</b> - (1) blade for 22" walk-behind.									
<b>B1MA2421</b>	22"	59/64 x 11/16"	5/16"	2-1/2"	2-1/4"	.125	Mulching	98-051	6424	335-608	\$12.50
		<b>OEM#: 742-0147, 942-0147-</b> For model 410 rider.									
<b>B1SB998</b>	25-5/8"	3/8"	5/16"	2-1/2"	2-1/2"	.187	--	--	998	--	\$25.10
		<b>OEM#: 742-0256, 742-0193, 942-0256-</b> (1) blade for 30" cut..									
<b>B1SB3354</b>	30"	3/8"	5/16"	2-1/2"	3"	.150	--	98-032	3354	335-646	\$32.00
<b>Murray</b>											
		<b>OEM#: 23209, 24338, 24458, 24458E701-</b> (3) blades for 42" cut..									
<b>B1MU2624</b>	15-1/32"	7/8 x 1"	--	--	2-1/4"	.156	--	97-100	844	335-786	\$9.00
		<b>OEM#: 20928E701-</b> (2) blades for 30" cut..									
<b>B1SB1122</b>	15-1/4"	7/8 x 1"	--	--	2-1/4"	.150	--	--	1122	--	\$9.80
		<b>OEM#: 92352E701-</b> (3) blades for 46" cut..									
<b>B1MU2618</b>	15-11/16"	27/32"	--	--	2-1/4"	.134	Low Lift	--	6161	--	\$9.00
		<b>OEM#: 56631E701-</b> (3) blades for 46" cut. Also used on Scotts mowers. 3-in-1 blade.									
<b>B1MU2623</b>	15-11/16"	7/8"	--	--	2-1/4"	.134	Mulching	97-017	6408	335-050	\$9.60









### Not all blades are made the same

Other blades may look like an XHT blade or a Predator blade, but Sunbelt's blades feature a unique steel called Marbain® that offers increased hardness as well as resistance to bending and impact damage. This results in a cutting edge that stays sharper, longer. That sharper edge gives a cleaner cut, keeping your lawn healthy and green.



Replacement Blades

JAYDEE P/N	LENGTH	CH-D	OH DIA	C TO C	WIDTH	THICK	APPLICATION	OREGON	ROTARY	STENS	PRICE
<b>Murray</b>											
 <b>OEM#: 92117E701-</b> (3) blades for 46" cut.											
<b>B1MU2612</b>	15-3/4"	27/32"	--	--	2-1/4"	.134	High Lift	97-123	6113	335-038	\$9.80
 <b>OEM#: 92117E701, 92117</b> - (3) blades for 46" cut. Heavy-duty.											
<b>B1MU2629</b>	15-3/4"	27/32"	--	--	2-1/4"	.187	High Lift	97-012	9896	--	\$12.00
 <b>OEM#: 92117E701, 56631E701-</b> (3) blades for 46" cut.											
<b>B1PD2000</b>	15-3/4"	27/32"	--	--	2-1/4"	.250	Mulching	97-906	6491	--	\$13.20
 <b>OEM#: 094692E701, 94692, 94692E701-</b> (3) blades for 48", 50", and 52" cut.											
<b>B1MU2632</b>	17-11/16"	13/16"	--	--	2-1/4"	.156	--	97-018	6470	335-075	\$9.80
 <b>OEM#: 54390E701-</b> (2) blades for 36" cut. (2) B1SB3429 and (2) B1MU2605 for 36" cut, blades cross for bagging.											
<b>B1MU2605</b>	18-3/16"	7/8 x 1"	--	--	2-1/4"	.156	--	97-105	6018	335-174	\$9.80
 <b>OEM#: 20930E701, 24116HT, 25116, 54372HT, 54390E701-</b> (2) blades for 36" cut.											
<b>B1MU2600</b>	18-1/4"	7/8 x 1"	--	--	2-1/4"	.156	--	97-106	1124	335-810	\$13.10
 <b>OEM#: 54421HT-</b> (2) B1SB3429 and (2) B1MU2605 for 36" cut. Blades cross for bagging.											
<b>B1SB3429</b>	18-1/4"	7/8 x 1"	--	--	2-15/16"	.150	--	--	3429	--	\$17.20
 <b>OEM#: 92003E701-</b> (2) blades for 38" cut. Sand blade.											
<b>B1MU2610</b>	19-1/4"	27/32"	--	--	2-1/4"	.156	Low Lift	97-010	6111	335-008	\$8.50
 <b>OEM#: 95104E701, 92543E701-</b> (2) blades for 38" cut. 3-in-1 blade.											
<b>B1MU2637</b>	19-7/16"	27/32"	--	--	2-1/4"	.156	Mulching	97-021	--	--	\$11.30
 <b>OEM#: 91742E701</b> - (2) blades for 38" cut.											
<b>B1MU2613</b>	19-1/2"	27/32"	--	--	2-1/4"	.156	High Lift	97-118	6017	335-012	\$10.20
 <b>OEM#: 91742E701-</b> (2) blades for 38" cut.											
<b>B1MU2604</b>	19-1/2"	27/32"	--	--	2-1/4"	.134	High Lift	97-107	6017	335-182	\$9.60

JAYDEE P/N	LENGTH	CH-D	OH DIA	C TO C	WIDTH	THICK	APPLICATION	OREGON	ROTARY	STENS	PRICE
<b>Murray</b>											
		<b>OEM#: 56250E701-</b> (2) blades for 38" cut.									
<b>B1MU2617</b>	19-1/2"	27/32"	--	--	2-3/4"	.134	Mulching	97-003	6146	335-475	\$11.00
		<b>OEM#: 56250E701, 456250-</b> (2) blades for 38" cut.									
<b>B1PD2001</b>	19-1/2"	27/32"	--	--	2-3/4"	.250	Mulching	97-902	6146	--	\$13.00
		<b>OEM#: 20045E701, 42785E701-</b> (1) blade for 20" push mower.									
<b>B1SB2012</b>	19-15/16"	13/32"	13/32"	2-1/2"	2-1/4"	.150	--	97-016	2012	335-760	\$9.90
		<b>OEM#: 672763, 672763E701-</b> (1) blade for 20" walk-behind.									
<b>B1SB10066</b>	20"	3/8"	--	--	2-3/4"	.150	Mulching	97-022	10066	--	\$10.60
		<b>OEM#: 91871, 91871E701, 92002HT, 491871, 91871HT, 92002, 92002E701</b> (2) blades for 40" cut. Fits models 40603, 40604, 40606, 40620, 40622, 1989-98. For bagging.									
<b>B1MU2631</b>	20-3/8"	27/32"	--	--	2-1/4"	.187	High Lift	97-119	6129	335-016	\$9.80
		<b>OEM#: 91871E701-</b> (2) blades for 40" cut.									
<b>B1MU2609</b>	20-3/8"	27/32"	--	--	2-1/4"	.134	High Lift	97-109	6034	335-166	\$10.10
		<b>OEM#: 92002E701-</b> (2) blades for 40" cut. Sand blade.									
<b>B1MU2611</b>	20-3/8"	27/32"	--	--	2-1/4"	.156	Low Lift	97-006	6112	335-030	\$9.00
		<b>OEM#: 56251E701, 92544E701, 95103E701-</b> (2) blades for 40" cut. 3-in-1 blade.									
<b>B1MU2634</b>	20-3/8"	27/32"	--	--	2-1/4"	.134	Mulching	97-024	6475	335-071	\$9.00

### Sprays to protect your mower

#### Mo-Deck Spray

When used regularly, MO-DECK non-stick spray for mowers dramatically reduces adhesion of grass clippings and deposits to mower deck preventing clipping build-up and clogging. Mo-Deck: so slick, grass won't stick. 11 oz. can.

**B1AC287**

\$8.00



#### Undercoating Spray











Tite-Seal Spray Auto Body Undercoating spray from Solder Seal/Gunk seals against moisture, dirt, and other corrosives. Use to protect mowers, tractors, farm implements, and automobiles from rust and corrosion. 16 oz. can, 12/case.

**B1AC128**











\$7.00











Replacement Blades

JAYDEE P/N	LENGTH	CH-D	OH DIA	C TO C	WIDTH	THICK	APPLICATION	OREGON	ROTARY	STENS	PRICE
<b>Murray</b>											
			<b>OEM#: 91871HT, 91871E701, 9187-853, 56251E701, 092002E701, 456251-</b> (2) blades for 40" cut.								
<b>B1PD2002</b>	20-3/8"	27/32"	--	--	2-1/2"	.250	Mulching	97-604	--	--	\$17.00
			<b>OEM#: 56251E701, 456251-</b> (2) blades for 40" cut.								
<b>B1MU2616</b>	20-3/8"	27/32"	--	--	2-3/4"	.134	Mulching	97-004	6145	335-479	\$10.10
			<b>OEM#: 71584E701, 672057E701-</b> (1) blade for 21" walk-behind.								
<b>B1MU2626</b>	20-3/4"	13/32"	--	--	2-1/4"	.134	Mulching	97-023	9228	--	\$10.20
			<b>OEM#: 43610E701, 43836E701-</b> (1) blade for 21" walk-behind. Fits models 21681X5 and 21681X62.								
<b>B1SB6039</b>	20-13/16"	13/32"	--	--	2-1/4"	.134	--	97-007	6039	--	\$11.80
			<b>OEM#: 22860, 22860E701</b> - (1) blade for 21" walk-behind. (1) blade for bagging.								
<b>B1SB3390</b>	20-13/16"	13/32"	--	2-1/2"	2-1/4"	.134	--	97-110	3390	335-869	\$12.00
			<b>OEM#: 71161E701-</b> (1) blade for 21" cut.								
<b>B1SB6160</b>	20-7/8"	13/32"	--	--	2-3/4"	.150	Mulching	--	6160	335-806	\$13.00
			<b>OEM#: 95100E701-</b> (2) blades for 42" cut. Also used on Scotts.								
<b>B1MU2627</b>	21-3/16"	27/32"	--	--	2-1/4"	.134	3-in-1	97-019	6476	335-054	\$9.80
			<b>OEM#: 95102E701-</b> (2) blades for 42" cut.								
<b>B1MU2630</b>	21-1/4"	27/32"	--	--	2-1/4"	.134	--	--	--	335-063	\$8.90
			<b>OEM#: 92418E701, 95101E701-</b> (2) blades for 42" cut.								
<b>B1MU2619</b>	21-1/4"	27/32"	--	--	2-1/4"	.156	High Lift	97-008	6162	335-764	\$9.90
			<b>OEM#: 92418, 92418E701-</b> (2) blades for 42" cut. Heavy-duty.								
<b>B1MU2628</b>	21-1/4"	27/32"	--	--	2-1/4"	.187	High Lift	97-013	9897	--	\$10.10
			<b>OEM#: 92419E701-</b> (2) blades for 42" cut.								
<b>B1MU2620</b>	21-1/4"	27/32"	--	--	2-1/4"	.156	Low Lift	97-014	6166	--	\$10.60



JAYDEE P/N	LENGTH	CH-D	OH DIA	C TO C	WIDTH	THICK	APPLICATION	OREGON	ROTARY	STENS	PRICE
<b>Murray</b>											
 OEM#: 92419E701, 95101E701, 92418E701, 495100, 95100E701, 656252-853 (2) blades for 42" cut.											
B1PD5003	21-1/4"	27/32"	--	--	2-1/4"	.250	Mulching	97-601	6460	--	\$17.00
 OEM#: 56252E701 - (2) blades for 42" cut.											
B1MU2615	21-1/4"	27/32"	--	--	2-3/4"	.134	3-in-1	97-005	6144	300-730	\$11.00
 OEM#: 42225E701, 20046E701, 42786E701- (1) blade for 22" walk-behind.											
B1MU2601	21-15/16"	13/32"	13/32"	2-1/2"	2-1/4"	.156	--	--	2013	335-778	\$10.90
 OEM#: 71499E701, 672735E701, 1101120E701, 7113E701, 71849E701- (1) blade for 22" walk-behind.											
B1MU2621	22"	13/32"	--	--	2-1/4"	.156	Mulching	97-001	6174	335-822	\$9.80
 OEM#: 55457E701- (1) blade for 25" cut.											
B1SB6030	24-3/4"	27/32"	--	--	2-1/4"	.134	Low Lift	--	6030	--	\$12.00
 OEM#: 56212E701, 55458, 56246E701, 56060E701- (1) blade for 30" cut.											
B1MU2608	30"	27/32"	--	--	2-3/4"	.165	High Lift	97-330	6027	--	\$15.30
 OEM#: 56210E701, 56217E701- (1) blade for 30" cut.											
B1MU2622	30"	27/32"	--	--	2-3/4"	.156	Mulching	97-009	6215	335-818	\$15.30
 OEM#: 24868E701, 54053E701, 25627- (1) blade for 30" cut.											
B1SB2166	30"	7/8 x 1"	--	--	2-1/4"	.150	High Lift	--	2166	335-844	\$17.50
 OEM#: 24524E701, 25626- (1) blade for 30" cut.											
B1SB2167	30"	7/8 x 1"	--	--	2-1/4"	.150	Low Lift	97-117	2167	335-836	\$17.00
 OEM#: 55793E701, 55454E701 - (1) blade for 30" cut.											
B1SB3443	30"	27/32"	--	--	2-1/4"	.187	Low Lift	97-115	3443	335-463	\$17.70
 OEM#: 56061E701, 24525, 54171, 55970- (1) blade for 30" cut.											
B1SB6010	30"	7/8 x 1"	--	--	2-3/4"	.160	High Lift	97-011	6010	335-004	\$18.00

Replacement Blades

JAYDEE P/N	LENGTH	CH-D	OH DIA	C TO C	WIDTH	THICK	APPLICATION	OREGON	ROTARY	STENS	PRICE
<b>Noma</b>											
		<b>OEM#: 300323, 9248, 00782972, 782971-</b> (1) B1SB6031 and (2) B1MU2606 for 45" deck									
<b>B1SB6031</b>	9-5/8"	3/8"	--	--	2"	.134	High Lift	--	6031	305-680	\$9.50
		<b>OEM#: 782974, 54882, 49312, 56370, 8581-</b> (3) blades for 42" cut. For AMF, Dynamark and Noma.									
<b>B1SB6456</b>	14-7/16"	3/8"	--	--	2-1/16"	.134	--	--	6456	305-573	\$9.90
		<b>OEM#: 8684, 42433, 25631, 56820, 54883, 00782971-</b> (2) blades for 32" rear engine rider.									
<b>B1SB6021</b>	16-1/8"	3/8"	--	--	1-15/16"	.134	High Lift	96-003	6021	305-516	\$8.60
		<b>OEM#: 42433, 00782971-</b> (2) blades for 32" cut.									
<b>B1SB1093</b>	16-1/4"	3/8"	--	--	2"	.150	--	--	1093	--	\$8.90
		<b>OEM#: 8685 39311, 56821, 782965-</b> (2) blades for 36" cut.									
<b>B1MU2603</b>	18-1/8"	3/8"	--	--	2"	.134	--	96-004	3447	--	\$8.90
		<b>OEM#: 39311, 56821, 782965, 8685, 54884, 124054, 031021-</b> (2) blades for 36" cut. Old style flat blade.									
<b>B1SB1085</b>	18-5/32"	3/8"	--	--	2"	.150	--	--	1085	305-524	\$9.10
		<b>OEM#: 58212, 306931-</b> (2) blades for 36" cut. (1) B1SB6031, and (2) B1MU2606 for 45" deck.									
<b>B1MU2606</b>	18-5/8"	3/8"	--	--	2-1/16"	.134	High Lift	--	6024	305-649	\$15.90
		<b>OEM#: 57299, 031039, 309069, 76860-</b> (2) blades for 39" cut. Fits Lawn Chief tractor									
<b>B1MU2602</b>	19-11/16"	3/8"	--	--	2"	.134	Low Lift	96-005	3406	305-599	\$8.40

**Blade balancers** (See our blade tools and accessories on pages 335-336)

**Magna-Matic Blade Balancer**

Our most precise blade balancer for the most demanding applications.

**B1SB9788** \$250.00



**Basic Blade Balancer**











This basic balancer will help increase the performance of your blades.











**B1SB1756** \$3.00



JAYDEE P/N	LENGTH	CH-D	OH DIA	C TO C	WIDTH	THICK	APPLICATION	OREGON	ROTARY	STENS	PRICE
<b>Noma</b>											
			<b>OEM#: 58190, 306932, 030544-0637, 12120-</b> (2) blades for 39" cut. Fits Lawn Chief tractor.								
<b>B1MU2607</b>	19-5/8"	3/8"	--	--	2-1/8"	.134	High Lift	96-120	6025	305-631	\$15.10
			<b>OEM#: 44198, 57210, 310764</b>								
<b>B1SB3336</b>	20"	3/8"	5/16"	2-1/8"	2"	.150	--	--	3336	--	\$10.20
			<b>OEM#: 309070, 303065-</b> (2) blades for 40" cut. Fits model A4016-030.								
<b>B1SB6099</b>	20-1/4"	3/8"	--	--	2-3/4"	.134	High Lift	96-011	6099	305-615	\$14.60
			<b>OEM#: 330278, 325762-</b> (2) blades for 43" cut. 3-in-1 blade.								
<b>B1MU2625</b>	21-31/64"	3/8"	--	--	2"	.187	Mulching	96-023	6286	305-068	\$15.80
			<b>OEM#: 310761, 57209-</b> (1) blade for 22" walk-behind side discharge. Fits models 223586 and 223587								
<b>B1SB6097</b>	21-1/2"	3/8"	3/8 x 15/16"	2-11/16"	2"	.134	--	--	6097	--	\$10.00
			<b>OEM#: 316608, 313954, 0194741-</b> (2) blades for 42" and 43" cut.								
<b>B1MU2614</b>	21-3/4"	13/32"	--	--	2"	.134	High Lift	96-012	6138	305-700	\$16.00
<b>Parker</b>											
			<b>OEM#: 66-238-A-1100-</b> Tine spring. Fits on tine reel assembly. Order in quantities of 101, priced individually. Coil Dia-13/16". Length over all 5". Length of coil-9/16". Thickness-3/32".								
<b>B1SB8590</b>	--	--	--	--	--	--	--	--	8590	--	\$0.70
<b>Sarlo</b>											
			<b>OEM#: 1511-</b> (1) blade for 21" cut walk-behind.								
<b>B1SB6230</b>	20-5/8"	5/8"	--	--	2-1/4"	.182	--	--	6230	--	\$13.00
			<b>OEM#: 1512-</b> (1) blade for 22" cut walk-behind model 622.								
<b>B1SB6228</b>	22"	5/8"	--	--	2-1/4"	.204	--	--	6228	--	\$16.00
			<b>OEM#: 1513-</b> (1) blade for 24" cut walk-behind models 624, 624-SPSW, WH624SP.								
<b>B1SB6231</b>	23-1/2"	5/8"	--	--	2-1/2"	.187	--	--	6231	--	\$17.80

Replacement Blades

JAYDEE P/N	LENGTH	CH-D	OH DIA	C TO C	WIDTH	THICK	APPLICATION	OREGON	ROTARY	STENS	PRICE
<b>Sarlo</b>											
		<b>OEM#: 1516-</b> (1) blade for 26" cut walk-behind models 1026SS, 1026-3SPSW, 626.									
<b>B1SB6232</b>	25-11/16"	3/4"	--	--	2-3/4"	.187	--	--	6232	--	\$17.00
<b>Scag</b>											
		<b>OEM#: A-48110, 481706, 482461-</b> (2) blades for 32" cut. (3) blades for 48" cut.									
<b>B1SC2800</b>	16-1/2"	5/8"	--	--	2-1/2"	.197	Notched	91-620	3403	340-109	\$12.40
		<b>OEM#: 482877-</b> (2) blades for 32" cut. (3) blades for 48" cut. Newer style blade with longer air lift.									
<b>B1SC3800</b>	16-1/2"	5/8"	--	--	2-1/2"	.197	Notched	91-621	3403	340-874	\$10.30
		<b>OEM#: A48184, 48304, 48111-</b> (2) blades for 32" cut. (3) blades for 48" cut.									
<b>B1PD5006</b>	16-1/2"	5/8"	--	--	2-1/2"	.250	Mulching	96-735	6300	302-617	\$19.70
		<b>OEM#: A48184, 481710-</b> (2) blades for 32" cut. (3) blades for 48" cut.									
<b>B1SC2804</b>	16-1/2"	5/8"	--	--	3"	.197	--	91-621	6009	340-113	\$18.00
		<b>OEM#: 481707, 48108, 482462-</b> (2) blades for 36" cut. (3) blades for 52" cut.									
<b>B1SC2801</b>	18"	5/8"	--	--	2-1/2"	.197	Notched	91-622	3404	340-158	\$13.50
		<b>OEM#: 482878-</b> (2) blades for 36" cut. (3) blades for 52" cut. Newer style blade with longer air lift.									
<b>B1SC3801</b>	18"	5/8"	--	--	2-1/2"	.197	Notched	91-637	3404	340-878	\$11.50
		<b>OEM#: 48185, 481707, 481711, 482462, 482467, A48108-</b> (2) blades for 36" cut. (3) blades for 52" cut.									
<b>B1PD5008</b>	18"	5/8"	--	--	2-1/2"	.250	Mulching	96-726	6294	302-618	\$20.80
		<b>OEM#: A48185, 481711-</b> (2) blades for 36" cut. (3) blades for 52" cut.									
<b>B1SC2803</b>	18"	5/8"	--	--	3"	.197	Notched	91-623	3442	340-121	\$17.90
		<b>OEM#: A48109 -</b> (2) blades for 40" cut.									
<b>B1SB6008</b>	20"	5/8"	--	--	2-1/2"	.204	Notched	91-624	6008	340-174	\$28.80
		<b>OEM#: A48111, 481708-</b> (3) blades for 61" cut.									
<b>B1SC2802</b>	21"	5/8"	--	--	2-1/2"	.197	Notched	91-626	3434	340-117	\$14.10

JAYDEE P/N	LENGTH	CH-D	OH DIA	C TO C	WIDTH	THICK	APPLICATION	OREGON	ROTARY	STENS	PRICE
<b>Scag</b>											
		<b>OEM#: 482881, 482879-</b> (3) blades for 61" cut. Newer style blade with longer air lift.									
<b>B1SC3802</b>	21"	5/8"	--	--	2-1/2"	.197	High Lift	91-638	3434	340-882	\$12.90
		<b>OEM#: 48111, 481712, 48304-</b> (3) blades for 61" cut. Fits Commercial Pro Cut.									
<b>B1EM1803</b>	21"	5/8"	--	--	2-1/2"	.250	Low Lift	--	--	303-188	\$17.00
		<b>OEM#: 481712-</b> (3) blades for 61" cut. Super high lift.									
<b>B1SC2807</b>	21"	5/8"	--	--	3"	.197	Notched	91-628	10930	340-099	\$19.90
		<b>OEM#: 48111, 48304, 482464-</b> (3) blades for 61" cut.									
<b>B1PD5010</b>	21"	5/8"	--	--	2-1/2"	.250	Mulching	96-727	6299	302-621	\$23.00
		<b>OEM#: 48112, 48113, 481709-</b> (3) blades for 72" cut.									
<b>B1SC2806</b>	24-1/2"	5/8"	--	--	2-1/2"	.197	--	91-627	6026	340-129	\$22.50
		<b>OEM#: 48112, 48113, 482002-</b> (3) blades for 72" cut.									
<b>B1PD2015</b>	24-1/2"	5/8"	--	--	2-1/2"	.250	Mulching	96-764	9883	--	\$21.90
<b>Simplicity</b>											
		<b>OEM#: 108297 -</b> (3) blades for 32" cut. Left hand cut. Fits models 600 and 5000 series.									
<b>B1SB1116</b>	11-9/16"	1-3/8"	3/8"	3-1/16"	2-1/2"	.150	--	--	1116	--	\$22.00
		<b>OEM#: 108501-</b> (3) blades for 36" cut. Left hand cut. Fits Allis Chalmers 2087731, Broadmoor 36.									
<b>B1SB1117</b>	13"	1-3/8"	3/8"	3-1/16"	2-1/2"	.150	--	--	1117	--	\$22.00
		<b>OEM#: 1656144, 2025856-</b> (3) blades for 42" cut. Fits 7000, 7100 series and diesel models, pre 1997, also fits GTH-L, 700, 900, 7000. Left hand cut.									
<b>B1SB2083</b>	14-1/2"	3/4"	13/32"	3-1/16"	2"	.150	--	91-712	2083	345-090	\$14.60
		<b>OEM#: 108298-</b> (3) blades for 42" cut. Allis Chalmers 2025856, and old Simplicity 165338. Left hand cut.									
<b>B1SB1118</b>	14-9/16"	1-3/8"	3/8"	3-1/16"	2-1/2"	.150	--	91-717	1118	345-025	\$13.50
		<b>OEM#: 1656147A-</b> (3) blades for 42" cut. Fits 600, 1300, 5000, 6000 series, also fits 51116, 5216, 6000, 6200, 6500, Sun Runner FC & GT series.									
<b>B1SP2901</b>	15-5/16"	3/4"	13/32"	2-9/16"	2"	.156	--	--	2081	345-074	\$12.40



## Xtreme Hardness & Toughness and Predator







The last steps in the process are painting, labeling, and packaging. Our blades are painted to prevent rust. Additionally, we put a label on each blade with the part number, bar code, and cross-reference information. Finally, we box our blades so that ordering and shipping is convenient as possible. Only now are these blades ready able to be called XHT and Predator.

**7**













JAYDEE P/N	LENGTH	CH-D	OH DIA	C TO C	WIDTH	THICK	APPLICATION	OREGON	ROTARY	STENS	PRICE
------------	--------	------	--------	--------	-------	-------	-------------	--------	--------	-------	-------









### Simplicity

 <b>OEM#: 1704856-</b> (1) B1SP2902 and (1) B1SP2903 for 38" cut. (3) blades for 44" cut. Fits right side for 38" cut LTH series. Also fits Allis-Chalmers.											
<b>B1SP2902</b>	16-1/8"	3/4"	13/32"	2-9/16"	2"	.197	--	91-723	10095	345-106	\$13.80
 <b>OEM#: 1704100A-</b> (3) blades for 44" cut. Fits small farm garden tractor 1989 and later. Also fits Allis-Chalmers.											
<b>B1SP2904</b>	16-1/8"	3/4"	13/32"	2-9/16"	2"	.197	--	91-705	10093	345-231	\$12.00
 <b>OEM#: 108448, 1656143-</b> (3) blades for 48" cut. Fits models GTH-L 700, 900, and 7000 series. Left hand cut.											
<b>B1SB2082</b>	16-11/16"	3/4"	13/32"	3-1/16"	2"	.150	--	91-711	2082	345-082	\$15.00
 <b>OEM#: 1657589, 1636451</b> - (2) blades for 36" cut. (1) B1SP2900 and (1) B1SP2078 for bagging.											
<b>B1SP2900</b>	18-1/2"	3/4"	13/32"	2-9/16"	2"	.187	--	91-713	2079	345-108	\$12.40
 <b>OEM#: 1671565, 1671593, 1685172-</b> (2) blades for 36" cut. (1) B1SB2078 and (1) B1SP2900 for bagging.											
<b>B1SB2078</b>	18-1/2"	3/4"	13/32"	2-9/16"	2-1/2"	.187	High Lift	91-714	2078	345-116	\$17.10
 <b>OEM#: 1708229-</b> (3) blades for 50" cut. Fits large frame tractors and Allis-Chalmers. Fits models 14-16GT and 1700 series.											
<b>B1SP2905</b>	18-9/64"	3/4"	13/32"	2-9/16"	2"	.197	--	91-706	10094	345-070	\$13.60



JAYDEE P/N	LENGTH	CH-D	OH DIA	C TO C	WIDTH	THICK	APPLICATION	OREGON	ROTARY	STENS	PRICE
<b>Simplicity</b>											
 <b>OEM#: 1704101</b> - (1) B1SP2902 and (1) B1SP2903 for 38" cut. Fits left side for 38" cut LTH series. Also fits Allis-Chalmers.											
<b>B1SP2903</b>	22-1/4"	3/4"	13/32"	2-9/16"	2"	.197	--	91-701	10096	345-102	\$16.00
<b>Snapper</b>											
 <b>OEM#:5101986-</b> (3) blades for 48" cut. Fits new iCD decks.											
<b>B1FE1048</b>	16-1/4"	5/8"	--	--	2-1/2"	.250	Notched	--	--	--	\$15.60
 <b>OEM#:2-9247, 7017043, 705771, 75771-</b> (3) blades for 48" cut.											
<b>B1SC2800</b>	16-1/2"	5/8"	--	--	2-1/2"	.197	Notched	91-620	3403	340-109	\$12.20
 <b>OEM#:29247-</b> For home owner model Yard Cruiser HZS 1848 2BVE.											
<b>B1SB6472</b>	16-1/2"	5/8"	--	--	2-1/2"	.204	--	--	6472	--	\$13.50
 <b>OEM#:1-9733-</b> (3) blades for 48" cut. Fits LT48 steel deck.											
<b>B1SN3008</b>	16-1/2"	3/8"	--	--	2-3/4"	.165	--	99-120	2169	320-994	\$14.00
 <b>OEM#:1-7043, 7-9369-</b> (3) blades for 48" cut. For ZTR mower.											
<b>B1SB6185</b>	16-13/16"	1/2"	--	--	2-1/2"	.204	Low Lift	91-126	6185	--	\$14.20
 <b>OEM#:7-9388-</b> (3) blades for 48" cut. For ZTR mower.											
<b>B1SB6035</b>	17"	1/2"	--	--	2-1/2"	.204	High Lift	91-123	6035	--	\$14.00
 <b>OEM#:1-7037, 29246-</b> (2) blades for 36" cut. (3) blades for 52" cut. Fits Snapper Pro series.											
<b>B1BU1300</b>	18"	5/8"	--	--	2-1/2"	.197	--	99-128	6014	303-180	\$14.40
 <b>OEM#: 5101756</b> - (3) blades for 52" cut. Fits new iCD decks.											
<b>B1FE1052</b>	18"	5/8"	--	--	2-1/2"	.250	Notched	--	--	--	\$17.00
 <b>OEM#:1-7037, 363055, 363245, 7-7344, 7-6450, 976450-</b> (2) blades for 36" cut. (3) blades for 52" cut.											
<b>B1PD5008</b>	18"	5/8"	--	--	2-1/2"	.250	Mulching	90-718	6294	303-116	\$21.70
 <b>OEM#:1708229-</b> (3) blades for 50" cut.											
<b>B1SP2905</b>	18-9/64"	3/4"	13/32"	2-9/16"	2"	.197	--	91-706	10094	345-070	\$13.60

Replacement Blades

JAYDEE P/N	LENGTH	CH-D	OH DIA	C TO C	WIDTH	THICK	APPLICATION	OREGON	ROTARY	STENS	PRICE
<b>Snapper</b>											
 <b>OEM#:2-4466, 4-2998-</b> (2) blades for 38" cut. Fits front engine rider models LT1438H and Black Hawk model BH120G38A.											
<b>B1SN3012</b>	19-41/64"	1"	--	--	2-1/4"	.197	--	99-116	6197	335-578	\$17.00
 <b>OEM#:1-9795-</b> (1) blade for 21" cut. (2) blades 41" cut. Punched for our B1SB910 high lift deflector.											
<b>B1SN3007</b>	20-11/16"	3/8"	3/8"	2-3/4"	2-3/4"	.165	High Lift	99-107	2007	335-240	\$14.00
 <b>OEM#:1-7168-</b> (1) blade for 21" cut.											
<b>B1SN3011</b>	20-11/16"	3/8"	3/8"	2-3/4"	2-3/4"	.165	Mulching	99-121	6110	335-042	\$18.00
 <b>OEM#:1-9702, 2-6691, 1-9645, 1-9710, 1-7002-</b> (1) blade for 21" cut. (2) blades for 41" cut, steel decks. Fits model LT11000.											
<b>B1SN3006</b>	20-3/4"	3/8"	3/8"	2-3/4"	2-3/4"	.165	--	99-103	2006	335-356	\$13.00
 <b>OEM#:1-7168, 1-9795, 1-9645, 1-9710, 1-9702, 2-6691, 1-7002-</b> (1) blade for 21" recycler walk-behind. (2) blades for 41" cut.											
<b>B1PD1030</b>	20-11/16"	3/8"	3/8"	2-3/4"	2-3/4"	.197	Mulching	96-620	6317	302-268	\$18.00
 <b>OEM#:1-8193-</b> (1) blade for 21" cut. Cast aluminum deck. Fits V series.											
<b>B1SB1087</b>	20-7/8"	7/8"	--	--	2-3/4"	.187	High Lift	--	1087	335-323	\$17.00
 <b>OEM#:7-9222-</b> (3) blades for 61" cut.											
<b>B1GH1902</b>	21"	1/2"	--	--	2-1/2"	.250	Low Lift	91-127	6167	320-006	\$15.20
 <b>OEM#:7-9222-</b> (3) blades for 61" cut. Heavy-duty.											
<b>B1GH1903</b>	21"	1/2"	--	--	2-1/2"	.250	High Lift	--	6168	320-014	\$16.00
 <b>OEM#:1-7081, 101733, 7017081-</b> (3) blades for 61" cut. Fits commercial Pro Cut.											
<b>B1EM1803</b>	21"	5/8"	--	--	2-1/2"	.250	Low Lift	--	--	303-188	\$17.00

**Blade Buster Blade Clamp**













The Blade Buster is a universal lawn mower blade clamp that saves both time and effort. It mounts directly to the mower deck and holds the blade safely and securely while the blade bolt is loosened and tightened. Simply turn the handle and the Blade Buster locks to the deck trapping the blade inside. Blade Buster comes packaged for retail display.











**B1DL100** \$12.00











See pages 335-336 for our complete line of blade grinders, sharpening stones, and other tools and accessories.













JAYDEE P/N	LENGTH	CH-D	OH DIA	C TO C	WIDTH	THICK	APPLICATION	OREGON	ROTARY	STENS	PRICE
<b>Snapper</b>											
 <b>OEM#:5101755-</b> (3) blades for 61" cut. For new iCD decks.											
<b>B1FE1061</b>	21"	5/8"	--	--	2-1/2"	.250	Notched	--	--	--	\$17.60
 <b>OEM#:7-9222, 7-9371-</b> (3) blades for 61" cut.											
<b>B1PD1022</b>	21"	1/2"	--	--	2-1/2"	.197	Mulching	99-615	6311	302-621	\$22.80
 <b>OEM#: 2-6428 -</b> (1) blade for 21" cut. (1) blade for Snapper walk-behind, Platinum series mowers.											
<b>B1SB6277</b>	21"	13/16"	3/8"	2-1/2"	2-1/4"	.134	--	--	6277	--	\$17.00
 <b>OEM#:1731898-</b> (2) blades for 42" cut. Fits LT-200 series & Zero Turn 150Z series.											
<b>B1SN3013</b>	21-3/16"	39/40"	--	--	2-1/4"	.170	--	--	12852	345-411	\$10.60
 <b>OEM#:1-9518-</b> (1) blade for 25" cut, rear engine rider, punched for new style high lift deflector (B1SB1136).											
<b>B1SN3005</b>	25"	1-1/16"	35/64"	7-1/2"	2-3/4"	.187	High Lift	99-106	1103	335-398	\$16.60
 <b>OEM#:1-8068-</b> (1) blade for 26" cut rear engine rider. Punched for our B1SB1131 high lift deflector.											
<b>B1SN3002</b>	26"	1-1/16"	35/64"	7-1/2"	2-3/4"	.187	High Lift	--	1091	335-299	\$16.80
 <b>OEM#:1-8038-</b> (1) blade for 30" cut. Older rear engine rider, also fits Dixon 30" rider. Punched for our B1SB1131 high lift deflector.											
<b>B1SB1089</b>	30"	7/8"	--	--	2-3/4"	.187	--	--	1089	335-281	\$22.10
 <b>OEM#:1-6980-</b> (1) blade for 28" cut rear engine rider.											
<b>B1SB6108</b>	28"	1-1/16"	35/64"	7-1/2"	2-3/4"	.160	Mulching	99-124	6108	335-289	\$19.00
 <b>OEM#:1-9515, 1-6980-</b> (1) blade for 28" cut rear engine rider.											
<b>B1PD2037</b>	28"	1-1/16"	35/64"	7-1/2"	2-3/4"	.250	Mulching	96-628	6302	--	\$23.00
 <b>OEM#:1-9515-</b> (1) blade for 28" cut rear engine riders. Punched for our new style B1SB1136 high lift deflector.											
<b>B1SN3004</b>	28"	1-1/16"	35/64"	7-1/2"	2-3/4"	.187	High Lift	99-113	1098	335-315	\$14.80
 <b>OEM#: 1-8069 -</b> (1) blade for 30" cut rear engine rider. Punched for our B1SB1131 high lift deflector.											
<b>B1SN3003</b>	30"	1-1/16"	35/64"	7-1/2"	2-3/4"	.187	High Lift	99-112	1092	335-307	\$15.10

Replacement Blades











JAYDEE P/N	LENGTH	CH-D	OH DIA	C TO C	WIDTH	THICK	APPLICATION	OREGON	ROTARY	STENS	PRICE
<b>Snapper</b>											
 <b>OEM#:1-8069-</b> (1) blade for 30" cut rear engine rider, new style commercial blade without air lift holes.											
<b>B1SN3009</b>	30"	1-1/16"	35/64"	7-1/2"	2-3/4"	.187	--	99-118	6029	--	\$17.00
 <b>OEM#:1-8069-</b> (1) blade for 30" cut rear engine rider.											
<b>B1PD2038</b>	30"	1-1/16"	35/64"	7-1/2"	2-3/4"	.250	Mulching	99-630	6297	--	\$26.00
 <b>OEM#:1-9523-</b> (1) blade for 33" cut rear engine rider. Punched for our new style B1SB1136 (3) bolt high lift deflectors.											
<b>B1SN3001</b>	33"	1-1/16"	35/64"	7-1/2"	2-3/4"	.187	High Lift	99-117	1060	335-331	\$17.60
 <b>OEM#:1-6982-</b> (1) blade for 33" cut rear engine rider.											
<b>B1SN3010</b>	33"	1-1/16"	35/64"	7-1/2"	2-3/4"	.165	Mulching	--	6109	335-293	\$18.90
 <b>OEM#:1-9523, 1-6982-</b> (1) blade for 33" cut rear engine rider.											
<b>B1PD2039</b>	33"	1-1/16"	9/16"	7-1/2"	2-3/4"	.250	Mulching	96-633	6301	--	\$27.00
<b>Snapper/Kees</b>											
 <b>OEM#:539-1032-74-</b> (3) blades for 42" cut.											
<b>B1HV1013</b>	14-7/8"	5/8"	--	--	2-1/2"	.197	--	95-058	7010	--	\$12.00
 <b>OEM#:7-7378, 483046, 48301-</b> (2) blades for 32" cut. (3) blades for 48" cut.											
<b>B1BC1201</b>	16-1/4"	5/8"	11/32"	1-5/8"	2-1/2"	.250	Notched	93-005	2172	335-008	\$13.40
 <b>OEM#: 539-100-340, 1-7036 -</b> (2) blades for 32" cut. (3) blades for 48" cut.											
<b>B1HV1016</b>	16-1/4"	5/8"	--	--	2-1/2"	.197	--	99-127	6500	303-168	\$12.00
 <b>OEM#:77878, 483011, 100340, 483046, 101366-</b> (2) blades for 32" cut. (3) blades for 48" cut.											
<b>B1PD5005</b>	16-1/4"	5/8"	--	--	2-1/2"	.250	Mulching	96-716	6296	302-616	\$22.00
 <b>OEM#:7-7344, 363245-</b> (2) blades for 36" cut. (3) blades for 54" cut.											
<b>B1BC1202</b>	18"	5/8"	--	--	2-1/2"	.250	Notched	91-184	2173	310-052	\$13.40
 <b>OEM#:100341, 77344, 363055, 976450, 363245-</b> (2) blades for 36" cut. (3) blades for 52" cut.											
<b>B1PD5008</b>	18"	5/8"	--	--	2-1/2"	.250	Mulching	96-726	6294	302-618	\$21.70

JAYDEE P/N	LENGTH	CH-D	OH DIA	C TO C	WIDTH	THICK	APPLICATION	OREGON	ROTARY	STENS	PRICE
<b>Southland</b>											
 <b>OEM#:2460-</b> (1) blade for 21" push mower.											
<b>B1SB6226</b>	20-7/8"	3/8"	3/8"	2"	2-1/4"	.150	--	--	6226	--	\$11.00
<b>Toro</b>											
 <b>OEM#:117192, 106077, 106636-</b> (3) blades for 42" cut. Side discharge.											
<b>B1TR3108</b>	13-7/8"	3/4"	--	--	2"	.187	--	91-805	2000	350-116	\$11.90
 <b>OEM#:100200, 6693-</b> (3) blades for 42" cut. Wheel Horse set of three 3-6693 for side discharge models RL-426, 5-1000 thru 5-1001, 5-1010, 5-1011, 5-1421 thru 5-1423, and 65-42, MSOL 1966-1976. OEM# 100200 for set of 3.											
<b>B1SB1108</b>	14"	3/4 x 5/8"	1/4"	1-5/8"	2"	.187	--	--	1108	350-041	\$12.50
 <b>OEM#: 106108, 106635 -</b> (3) blades for 42" cut. Rear discharge.											
<b>B1SB851</b>	14-1/2"	3/4"	--	--	2"	.204	--	91-804	851	350-108	\$11.80
 <b>OEM#:79-2920, 14-4879-</b> (3) blades for 42" cut. Fits ZTR mower with 42" deck.											
<b>B1SB6267</b>	14-1/2"	3/4"	--	--	2-1/2"	.187	Mulching	--	6267	--	\$13.30
 <b>OEM#:55-4940-</b> (3) blades for 44" cut. Fits model 30144, mid-size cutting mower, wide area walk-behind.											
<b>B1SB3393</b>	15-1/2"	5/8"	--	--	2-1/2"	.187	High Lift	94-039	3393	345-486	\$18.60
 <b>OEM#:92-7952-</b> (3) blades for 44" cut.											
<b>B1TR3105</b>	15-1/2"	5/8"	--	--	2-1/2"	.187	--	--	6326	--	\$12.70
 <b>OEM#:54-0010, 54-0010-03-</b> (3) blades for 44" cut. Deck 57358, Groundsmaster model 117 and 1144 rider.											
<b>B1TR3111</b>	15-1/2"	5/8"	--	--	2-1/2"	.187	--	94-026	3441	345-454	\$12.10
 <b>OEM#:55-4940, 54-0010-</b> (3) blades for 44" cut wide area walk-behind.											
<b>B1PD5051</b>	15-1/2"	5/8"	--	--	2-1/2"	.197	Mulching	96-305	9885	--	\$14.00
 <b>OEM#:106637, 106078-</b> (3) blades for 48" cut. Side discharge.											
<b>B1TR3109</b>	16"	3/4"	--	--	2"	.187	--	91-806	2001	350-124	\$11.00
 <b>OEM: 122-0304 -</b> (2) B1MA2402 and (1) B1AM2431 for 46" cut.											
<b>B1MA2402</b>	16-1/4"	"H" Pattern	5/16"	2-1/2"	2-1/2"	.156	--	98-063	1029	335-691	\$9.10











Replacement Blades











JAYDEE P/N	LENGTH	CH-D	OH DIA	C TO C	WIDTH	THICK	APPLICATION	OREGON	ROTARY	STENS	PRICE
<b>Toro</b>											
 <b>OEM#:107-3192, 107-3192-03, 110-0414, 110-0418-</b> (2) blades for 32" cut. (3) blades for 48" cut.											
<b>B1SC2800</b>	16-1/2"	5/8"	--	--	2-1/2"	.197	Notched	91-620	3403	340-109	\$12.60
 <b>OEM#:84-4370, 93-0107-</b> (1) B1SB6187 and (1) B1SB6188 for 37" cut. Fits deck model 30137. Left hand cut. Short blade											
<b>B1SB6187</b>	16-7/8"	21/32"	--	--	2-1/4"	.187	--	--	6187	--	\$16.90
 <b>OEM#:113579, 30227-</b> (3) blades for 50" cut. Fits wheel horse 718Z and 724Z.											
<b>B1DC1500</b>	17"	5/8"	--	--	2-1/2"	.197	--	91-502	3372	350-199	\$11.00
 <b>OEM#:113579, 30227-</b> (3) blades for 50" cut. Fits models 718Z and Toro ZTR. Heavy-duty.											
<b>B1DC1502</b>	17"	5/8"	--	--	2-1/2"	.197	Notched	91-505	--	303-144	\$12.40
 <b>OEM#:113579, 30227-</b> (3) blades for 50" cut.											
<b>B1PD2007</b>	17"	5/8"	--	--	2-1/2"	.250	Mulching	96-723	6298	--	\$14.60
 <b>OEM#:33-0490-</b> (2) blades for 36" cut. Toro rear bagger and Grassmaster.											
<b>B1SB2060</b>	18"	7/16"	--	--	2-5/8"	.125	--	--	2060	--	\$16.20
 <b>OEM#:44-5480, 27-0990-</b> (2) blades for 36" cut. (3) blades for 52" cut. Fits walk-behind, Groundsmaster, and Time Cutter ZTR models.											
<b>B1TR3101</b>	18"	1/2"	--	--	2-1/2"	.187	--	94-018	3361	345-405	\$13.00
 <b>OEM#: 56-2390-</b> (2) blades for 36" cut. (3) blades fo 52" cut. Wide area walk-behind.											
<b>B1TR3103</b>	18"	1/2"	--	--	2-1/2"	.187	High Lift	94-022	3405	345-462	\$14.90
 <b>OEM#:27-0990, 56-2390, 92-7961-</b> (2) blades for 36" cut. (3) blades for 52" cut.											
<b>B1PD1031</b>	18"	1/2"	--	--	2-1/2"	.197	Mulching	94-618	6410	302-618	\$16.70
 <b>OEM#:55-4210-</b> (2) blades for 36" cut. (3) blades for 52" cut. Fits model 30136 and 30152, for midsize mowers.											
<b>B1SB3394</b>	18"	5/8"	--	--	2"	.187	--	--	3394	--	\$20.00
 <b>OEM#:109918, 109079-</b> (2) blades for 37" cut. Side discharge.											
<b>B1TR3112</b>	18-3/4"	3/4"	--	--	2"	.197	--	91-817	3468	350-157	\$14.00













JAYDEE P/N	LENGTH	CH-D	OH DIA	C TO C	WIDTH	THICK	APPLICATION	OREGON	ROTARY	STENS	PRICE
<b>Toro</b>											
 <b>OEM#:8-5240-</b> For Toro Whirl Wind 1972-1976 and Guardian 1971-1973 walk-behind mower.											
<b>B1SB1011</b>	19"	7/16"	--	--	2-1/4"	.134	--	--	1011	--	\$19.50
 <b>OEM#:14-7799, 79-3060, 79-3061-</b> (2) blades for 38" cut. ZTR models 616 and 620											
<b>B1TR3104</b>	19-1/4"	5/8"	--	--	2-1/2"	.187	Mulching	94-032	6184	345-165	\$14.20
 <b>OEM#:57-4700-</b> (2) blades for 38" cut. Fits 612, 616, and 620 ZT also fits 200 series side-discharge. Front engine rider.											
<b>B1SB3395</b>	19-5/16"	5/8"	--	--	2-1/2"	.187	High Lift	94-038	3395	345-447	\$19.00
 <b>OEM#:69-6920-</b> (11) blades for 16' deck Groundsmaster. Fits Toro 580D mower..											
<b>B1T3107</b>	20"	5/8"	--	--	2-1/2"	.250	--	94-029	6270	345-156	\$14.00
 <b>OEM#: 93-0241</b> - (1) blades for 21" Toro Recycler with 4.5 HP motor model 20444 walk-behind.											
<b>B1SB6275</b>	20-1/4"	7/16"	3/8"	2-1/2"	2-1/2"	.134	--	94-001	6275	--	\$18.20
 <b>OEM#:112947-</b> (3) blades for 60" cut. Fits Wheel Horse.											
<b>B1SB9171</b>	20-1/2"	5/8"	--	--	2-1/2"	.204	--	91-503	9171	--	\$19.50
 <b>OEM#:108-3762-03, 93-4106-03-</b> (1) blade for 21" Recycler walk-behind.											
<b>B1SB10928</b>	20-27/32"	7/16"	3/8"	2-1/2"	2-1/4"	.150	--	--	10928	345-429	\$15.00
 <b>OEM#:14-9419, 75-9420, 119419, 14-1659, 75-94201, 80-510, 91-2256-</b> (1) blade for 21" cut.											
<b>B1SB6256</b>	20-15/16"	7/16"	3/8"	2-7/16"	2-9/16"	.134	--	94-127	6256	345-173	\$17.50
 <b>OEM#:20-2720-</b> (1) blade for 21" cut. Whirl Wind 11 models 1977 and later, Guardian.											
<b>B1SB1006</b>	21"	7/16"	--	--	2-5/8"	.125	--	--	1006	345-348	\$18.20
 <b>OEM#:8-5230-</b> (1) blade for 21" cut. New Toro Whirl Wind. Whirl Wind models 1972-1976 and Guardian models 1971-1973.											
<b>B1SB1012</b>	21"	7/16"	--	--	2-5/8"	.125	--	--	1012	345-306	\$17.60
 <b>OEM#:42-1000, 26-0880-</b> (1) blade for 21" cut. Toro rear bagger and Grassmaster models 1974-1977, use on models with blade brake clutch.											
<b>B1TR3100</b>	21"	7/16"	3/8"	2-7/16"	2-5/8"	.125	--	94-017	1008	345-397	\$17.50

Replacement Blades

JAYDEE P/N	LENGTH	CH-D	OH DIA	C TO C	WIDTH	THICK	APPLICATION	OREGON	ROTARY	STENS	PRICE
<b>Toro</b>											
 <b>OEM#:44-6250-</b> (3) blades for 62" cut. Fits Toro 62" Groundsmaster.											
<b>B1TR3106</b>	21-1/2"	1/2"	--	--	2-1/2"	.187	--	94-019	6251	345-421	\$15.00
 <b>OEM#: 44-6250</b> - (3) blades for 62" cut. Fits Groundsmaster models.											
<b>B1PD2053</b>	21-1/2"	1/2"	--	--	2-1/2"	.250	Mulching	97-721	--	--	\$22.80
 <b>OEM#:106-2247-03-</b> (2) blades for 42" cut. Fits Time Cutter Z.											
<b>B1SB11821</b>	21.675"	5/8"	--	--	2-1/4"	.160	--	94-068	11821	350-219	\$17.90
 <b>OEM#:104-8697-03-</b> (1) blade for 22" Recycler walk-behind, Personal Pace models.											
<b>B1TR3115</b>	21-23/32"	7/16"	--	--	2-1/4"	.156	--	94-322	10929	345-037	\$11.00
 <b>OEM#:105-7784, 105-7784-03-</b> (3) blades for 72" Z500 Z Master..											
<b>B1EM1850</b>	24-7/16"	5/8"	--	--	3"	.197	Notched	91-374	6481	355-117	\$18.00
 <b>OEM#:29-5530, 23-2410-</b> (3) blades for 72" cut. Fits Groundsmaster. Left hand cut.											
<b>B1TR3102</b>	25"	3/4"	--	--	2-1/2"	.250	Heavy-Duty	94-011	3362	345-314	\$22.70
 <b>OEM#:98-3028-</b> (1) B1SB6443 and (1) B1SB6444 for 48" cut. Right hand blade. Fits model 320.											
<b>B1SB6443</b>	25"	7/8"	17/64"	3"	2-1/2"	.187	--	--	6443	--	\$22.70
 <b>OEM#:98-3029-</b> (1) B1SB6443 and (1) B1SB6444 for 48" cut. Left hand blade. Fits model 320.											
<b>B1SB6444</b>	25"	7/8"	17/64"	3"	2-1/2"	.187	--	--	6444	--	\$22.70
 <b>OEM#:80-4530-</b> (1) blade for 25" rear engine rider.											
<b>B1SB6117</b>	25-3/16"	5/8"	--	--	2-1/2"	.187	Mulching	--	6117	--	\$23.00
 <b>OEM#: 85-6040</b> - (3) blades for 72" cut. Fits Groundsmaster models 322D, 322, 325D, 325. Heavy duty.											
<b>B1SB6271</b>	25-7/32"	1/2"	--	--	2-1/2"	.250	Mulching	94-040	6271	345-177	\$20.80
 <b>OEM#:670200-</b> (1) blade for 25" cut.											
<b>B1SB6001</b>	25-7/32"	5/8"	--	--	2-1/2"	.187	--	--	6001	--	\$23.00





JAYDEE P/N	LENGTH	CH-D	OH DIA	C TO C	WIDTH	THICK	APPLICATION	OREGON	ROTARY	STENS	PRICE
<b>Toro</b>											
		<b>OEM#:80-4430-</b> (1) blade for 32" cut rear engine rider.									
<b>B1SB6118</b>	31-3/8"	5/8"	--	--	2-1/2"	.187	Mulching	94-033	6118	345-338	\$28.00
		<b>OEM#:33-4750-</b> (1) blade for 32" cut.									
<b>B1TR3110</b>	31-3/8"	5/8"	--	--	2-1/2"	.187	--	94-021	2171	345-413	\$23.00
<b>Troy Bilt</b>											
		<b>OEM#:1772335-</b> (2) blades for 36" cut.									
<b>B1SP2900</b>	18-1/2"	3/4"	13/32"	2-9/16"	2"	.187	--	91-713	6069	345-108	\$12.40
<b>Trailmate</b>											
		<b>OEM#:16584-</b> (1) blade for 22" cut high wheel mower. Straight blade with lift.									
<b>B1SB6258</b>	21-1/2"	1"	7/16"	2-1/2"	2-1/2"	.187	--	--	6258	--	\$14.00
		<b>OEM#:16588-</b> (1) blade for 25" cut high wheel mowers. Straight blade with lift.									
<b>B1SB6257</b>	24-1/2"	1"	7/16"	2-1/2"	2-1/2"	.187	--	--	6257	--	\$14.40
		<b>OEM#:16587-</b> (1) blade for 25" cut high wheel mower. Formed blade.									
<b>B1SB6259</b>	24-1/2"	1"	7/16"	2-1/2"	2-1/2"	.187	--	--	6259	--	\$14.60
<b>Walker</b>											
		<b>OEM#:5705-0-</b> (1) B1SB3423 and (1) B1SB3422 for 36" cut, for rear discharge. (3) blades for 54" cut, for side discharge.									
<b>B1SB3423</b>	20"	5/8"	3/16"	3"	2-3/4"	.160	--	91-911	3423	--	\$16.20
		<b>OEM#:5705-10-</b> (2) blades for 42" cut.									
<b>B1SB6176</b>	21-1/16"	5/8"	13/64"	3"	2-3/4"	.164	Mulching	--	6176	--	\$17.30
		<b>OEM#:5705-4-</b> (1) B1WA3400 and (1) B1WA3401 for 42" cut. (3) blades for 54" cut. Grass handling system. Rear discharge. Left hand cut.									
<b>B1WA3400</b>	22"	5/8"	3/16"	3"	2-3/4"	.165	--	91-912	3445	355-032	\$14.80
		<b>OEM#:5705-3-</b> (1) B1WA3400 and (1) B1WA3401 for 42" cut. (3) blades for 54" cut. Grass handling system. Rear discharge. Right hand cut.									
<b>B1WA3401</b>	22"	5/8"	3/16"	3"	2-3/4"	.165	--	91-913	3446	355-024	\$15.00

Replacement Blades





JAYDEE P/N	LENGTH	CH-D	OH DIA	C TO C	WIDTH	THICK	APPLICATION	OREGON	ROTARY	STENS	PRICE
<b>Walker</b>											
 <b>OEM#:7705-2-</b> (1) B1WA3402 and (1) B1WA3403 for 48" cut. Left hand cut.											
<b>B1WA3402</b>	25-1/16"	5/8"	7/32"	3"	2-3/4"	.165	--	91-919	6169	355-713	\$17.60
 <b>OEM#:7705-1-</b> (1) B1WA3402 and (1) B1WA3403 for 48" cut. Right hand cut.											
<b>B1WA3403</b>	25-1/16"	5/8"	7/32"	3"	2-3/4"	.165	--	91-920	6170	335-709	\$17.80
<b>Wood Brothers</b>											
 <b>OEM#: 70014, 70014 KT</b> - (3) blades for 44" cut.											
<b>B1SB3377</b>	15"	1/2"	--	--	2"	.204	--	91-545	3377	320-028	\$13.20
 <b>OEM#:70062, 70062KT-</b> (3) blades for 44" cut.											
<b>B1SB3378</b>	15"	1/2"	--	--	2"	.204	High Lift	--	3378	320-010	\$14.90
 <b>OEM#:70104, 70104KT-</b> (3) blades for 52" cut.											
<b>B1GH1900</b>	18"	1/2"	--	--	2"	.197	--	91-546	3379	320-048	\$12.60
 <b>OEM#:70117, 70117KT-</b> (3) blades for 52" cut.											
<b>B1GH1901</b>	18"	1/2"	--	--	2"	.197	High Lift	--	3380	320-036	\$12.60
 <b>OEM#:70104, 70104KT, 70117, 70117KT-</b> (3) blades for 52" cut.											
<b>B1PD1021</b>	18"	1/2"	--	--	2-1/2"	.197	Mulching	96-329	6309	302-244	\$18.00
 <b>OEM#:6234, 6950, 6950KT-</b> (3) blades for 60" cut. Fits model 59C2.											
<b>B1SB6467</b>	20-3/16"	5/8"	--	--	2"	.203	Medium Lift	91-762	6467	345-769	\$13.00
 <b>OEM#:23825, 23825KT, 31359, 31359KT-</b> (3) blades for 60" cut. Fits models RM500, F35, RM59, L59. Left hand cut.											
<b>B1WD3500</b>	20-3/16"	5/8"	--	--	2"	.197	--	91-761	3421	345-777	\$12.40
 <b>OEM#:34615, 34615KT-</b> (3) blades for 60" cut. Fits new Tunnel deck models RM360 RM550											
<b>B1SB6433</b>	20-11/16"	5/8"	--	--	2-1/2"	.240	High Lift	90-225	6433	345-668	\$18.00
 <b>OEM#:70134, 70134KT-</b> (3) blades for 61" cut.											
<b>B1GH1902</b>	21"	1/2"	--	--	2-1/2"	.250	Heavy-Duty	91-547	6167	320-006	\$15.40

JAYDEE P/N	LENGTH	CH-D	OH DIA	C TO C	WIDTH	THICK	APPLICATION	OREGON	ROTARY	STENS	PRICE
------------	--------	------	--------	--------	-------	-------	-------------	--------	--------	-------	-------

**Wood Brothers**

 <b>OEM#:70142, 70142KT-</b> (3) blades for 61" cut. Heavy-duty.											
<b>B1GH1903</b>	21"	1/2"	--	--	2-1/2"	.250	High Lift	--	6168	320-014	\$15.00
 <b>OEM#:70134, 70134KT, 70142, 70142KT-</b> (3) blades for 61" cut.											
<b>B1PD1022</b>	21"	1/2"	--	--	2-1/2"	.197	Mulching	96-712	6311	302-248	\$22.00
 <b>OEM#:13404, 13404KT, 31306, 31306KT</b> (3) blades for 72" cut. Fits models L306, RM306, RM600. Left hand cut.											
<b>B1SB6210</b>	24-1/2"	1"	--	--	2-1/2"	.204	--	91-764	6210	345-785	\$20.20
 <b>OEM#: 15127, 15127KT</b> - (3) blades for 72" cut. Fits new Tunnel deck, models RM3372 and RM660											
<b>B1SB6434</b>	24-11/16"	5/8"	--	--	2-1/2"	.240	High Lift	91-766	6434	345-672	\$21.40

**Wright**











 <b>OEM#:71440002-</b> (2) blades for 32" cut. (3) blades for 48" cut.											
<b>B1SC2800</b>	16-1/2"	5/8"	--	--	2-1/2"	.197	Notched	91-620	3403	340-109	\$12.40
 <b>OEM#:71440001-</b> (2) blades for 36" cut. (3) blades for 52" cut.											
<b>B1SC2801</b>	18"	5/8"	--	--	2-1/2"	.197	Notched	91-622	3404	340-158	\$13.00
 <b>OEM#:71440003-</b> (3) blades for 61" cut.											
<b>B1SC2802</b>	21"	5/8"	--	--	2-1/2"	.197	Notched	91-626	3434	340-117	\$14.40
 <b>OEM#:71440003-</b> (3) blades for 61" cut. Fits Commercial Pro Cut.											
<b>B1EM1803</b>	21"	5/8"	--	--	2-1/2"	.250	Low Lift	--	--	303-188	\$16.40

**Tips to improve mower performance**









1. Keep mower blades sharp and the deck thoroughly clean.
2. Run the throttle wide open only when mowing. This will ensure that optimal blade tip speed is obtained for best cut quality.
3. Slow down. Try to match your ground speed to grass conditions. In most cases, slower ground speeds will give a better cut.
4. Try not to cut more than 1/3 of the grass blade off in any single mowing.
5. Make sure that your deck is leveled according to the manufacturer's specifications.
6. For best appearance, change your mowing pattern each time you mow. If you must mow in the same direction, change the starting point of your first pass each time you mow.
7. If you have a riding mower, be sure to adjust your deck wheels so that they are just off the ground when the mower is parked on a hard surface. This adjustment allows the mower deck to follow the contour of the ground while preventing scalping where the ground is rough or uneven.



Replacement Blades

JAYDEE P/N	LENGTH	CH-D	OH DIA	C TO C	WIDTH	THICK	APPLICATION	OREGON	ROTARY	STENS	PRICE
 <b>OEM#:100340-</b> (3) blades for 48" cut.											
<b>B1BC1200</b>	16-1/4"	5/8"	1/4"	1-5/8"	2-1/2"	.187	Notched	93-002	1009	310-003	\$12.00
 <b>OEM#:100340-</b> (2) blades for 32" cut. (3) blades for 48" cut.											
<b>B1PD5005</b>	16-1/4"	5/8"	--	--	2-1/2"	.250	Mulching	96-716	6296	302-616	\$22.00
 <b>OEM#:OH2123-</b> (3) blades for 48" cut.											
<b>B1SB9177</b>	16-15/16"	1/2"	--	--	2-1/2"	.204	Mulching	--	9177	--	\$17.00
 <b>OEM#:100341-</b> (3) blades for 52" cut.											
<b>B1BC1202</b>	18"	5/8"	--	--	2-1/2"	.250	Notched	93-006	2173	310-052	\$12.50
 <b>OEM#:100341-</b> (2) blades for 36" cut. (3) blades for 52" cut.											
<b>B1PD5008</b>	18"	5/8"	--	--	2-1/2"	.250	Mulching	96-726	6294	303-116	\$21.80
 <b>OEM#:206-978-</b> (3) blades for 62" cut. Use on PSR-62 deck.											
<b>B1SB6759</b>	20-11/32"	5/8"	--	--	2-1/4"	.204	--	--	6759	--	\$22.50
 <b>OEM#:206-660-</b> (3) blades for 60" cut. Fits PSR-60. RH cut.											
<b>B1SB6284</b>	20-3/4"	3/4 x 1-1/4"	--	--	2-1/4"	.240	--	91-859	6284	350-603	\$26.00
 <b>OEM#:101733-</b> (3) blades for 61" cut.											
<b>B1BC1206</b>	21"	5/8"	--	--	2-1/2"	.250	Notched	93-011	3402	310-086	\$15.80
 <b>OEM: 101733 -</b> (3) blades for 61" cut.											
<b>B1PD5010</b>	21"	5/8"	--	--	2-1/2"	.250	Mulching	96-702	6299	302-821	\$23.00
 <b>OEM#:206-622-</b> (1) blade for 22" cut walk-behind.											
<b>B1SB9176</b>	22"	3/4 x 1-1/4"	--	--	2-1/4"	.240	--	--	9176	--	\$23.00
 <b>OEM#:105476-</b> (3) blades for 72" cut.											
<b>B1SC2806</b>	24-1/2"	5/8"	--	--	2-1/2"	.197	--	91-627	6026	340-129	\$23.00











JAYDEE P/N	LENGTH	CH-D	OH DIA	C TO C	WIDTH	THICK	APPLICATION	OREGON	ROTARY	STENS	PRICE
<b>Yazoo</b>											
			<b>OEM#:105476-</b> (3) blades for 72" cut.								
<b>B1PD2015</b>	24-1/2"	5/8"	--	--	2-1/2"	.250	Mulching	90-464	9883	303-132	\$21.50
<b>Universal</b>											
			<b>OEM#:</b> --- Mulching								
<b>B1UN3200</b>	20"	3/8"	3/8 x 1-1/2"		2-1/4"	.156	Mulching	90-620	6044	300-525	\$10.00
			<b>OEM#:</b> --- Mulching								
<b>B1UN3201</b>	21"	3/8"	3/8 x 1-1/2"		2-1/4"	.156	Mulching	90621	6045	300-517	\$11.60
			<b>OEM#:</b> --- Mulching								
<b>B1SB6046</b>	22"	3/8"	3/8 x 1-1/2"		2-1/4"	.150	Mulching	90-622	6046	300-509	\$13.00
			<b>OEM#:</b> --- Super Lift								
<b>B1SB2094</b>	18"	3/8"	3/8 x 1-1/2"		2-1/4"	.150	Super Lift	--	2094	--	\$13.20
			<b>OEM#:</b> --- Straight suction lift.								
<b>B1UN3202</b>	22"	1"	3/8 x 1-1/2"		2-1/4"	.156	Suction Lift	90-336	955	300-160	\$9.80
			<b>OEM#:</b> ---Straight suction lift								
<b>B1UN3203</b>	19"	3/8"	3/8 x 1-1/2"		2-1/4"	.156	Suction Lift	90-143	978	300-012	\$9.60
			<b>OEM#:</b> --- Straight suction lift								
<b>B1UN3204</b>	20"	3/8"	3/8 x 1-1/2"		2-1/4"	.156	Suction Lift	90-144	979	300-020	\$9.60
			<b>OEM#:</b> --- Straight suction lift								
<b>B1UN3205</b>	21"	3/8"	3/8 x 1-1/2"		2-1/4"	.156	Suction Lift	90-145	980	300-038	\$9.60

Replacement Blades





JAYDEE P/N	LENGTH	CH-D	OH DIA	C TO C	WIDTH	THICK	APPLICATION	OREGON	ROTARY	STENS	PRICE
------------	--------	------	--------	--------	-------	-------	-------------	--------	--------	-------	-------

**Universal**

 <b>OEM#:</b> --- Straight suction lift											
<b>B1UN3206</b>	22"	3/8"	3/8 x 1-1/2"		2-1/4"	.156	Suction Lift	90-146	981	300-046	\$9.60
 <b>OEM#:</b> --- Offset suction lift											
<b>B1SB990</b>	20"	3/8"	3/8 x 1-1/2"		2-1/4"	.150	Suction Lift	90-124	990	300-087	\$11.00
 <b>OEM#:</b> --- Offset suction lift											
<b>B1SB991</b>	21"	3/8"	3/8 x 1-1/2"		2-1/4"	.150	Suction Lift	90-125	991	300-095	\$11.00
 <b>OEM#:</b> --- Offset suction lift											
<b>B1UN3207</b>	22"	3/8"	3/8 x 1-1/2"		2-1/4"	.156	Suction lift	90-126	992	300-103	\$10.00
 <b>OEM#:</b> --- (2) blades for 32" cut. (3) blades for 48" cut. Sharpened - 4 sides.											
<b>B1SB10172</b>	16-1/4"	5/8"	--	--	2-1/2"	.204	Sand Blade	--	10172	--	\$17.20
 <b>OEM#:</b> --- (2) blades for 38" cut. (3) blades for 52", 54" cut. Sharpened-4 sides.											
<b>B1SB10173</b>	18"	3/8"	--	--	2-1/2"	.204	Sand Blade	--	10173	--	\$18.00
 <b>OEM#:</b> --- (2) blades for 40" cut. (3) blades for 60" cut. Sharpened-4 sides.											
<b>B1SB10175</b>	20-1/2"	5/8"	--	--	2-1/2"	.204	Sand Blade	--	10175	--	\$21.70
 <b>OEM#:</b> --- (3) blades for 61" cut. Sharpened-4 sides											
<b>B1SB10174</b>	21"	5/8"	--	--	2-1/2"	.204	Sand Blade	--	10174	--	\$22.00
 <b>OEM#:</b> --- (3) blades for 61" cut.											
<b>B1SB9969</b>	21"	5/8"	--	--	2"	.240	Low Lift	--	9969	--	\$18.60

**Multi-Application**

 <b>OEM#:</b> Bad Boy: 038-4820-00; Bobcat: 32061A, WM132022, 32022HD, 03239 WMTA32061, 112111-01, 32061; Exmark: 403059, 403026, 403086; Husqvarna: 403059, 403026, 403086; Jacobsen: 3090666; Kees: 77878, 483011 100340, 483046, 101366; Ferris: 1520843; Yazoo: 100340 (2) blades for 32" cut. (3) blades for 48" cut.											
<b>B1PD5005</b>	16-1/4"	5/8"	--	--	2-1/2"	.250	Mulching	96-716	6296	302-616	\$21.50

JAYDEE P/N	LENGTH	CH-D	OH DIA	C TO C	WIDTH	THICK	APPLICATION	OREGON	ROTARY	STENS	PRICE
<b>Multi-Application</b>											
 <p><b>OEM#:</b>Bunton: A48110; Encore: 483035, 453024; Great Dane: D18086, GDU10230; John Deere: M115495; Lesco: 021871, 50111; Scag: A48184, 48304, 48111; Snapper: 1-7043- (2) blades for 32" cut. (3) blades for 48" cut.</p>											
B1PD5006	16-1/2"	5/8"	--	--	2-1/2"	.250	Mulching	96-735	6300	302-617	\$21.00
 <p><b>OEM#:</b>Dixie Chopper: 30227-50H, A30227-50N, 30227-N, 30227-H; Dixon: 9265, 9258; Gravely: 46998, 08779251, 08899600- (3) blades for 50" cut.</p>											
B1PD2007	17"	5/8"	--	--	2-1/2"	.250	Mulching	96-723	6298	303-396	\$16.00
 <p><b>OEM#:</b>Bad Boy: 038-3000-00; Bobcat: 42180B, 112111-02; Bunton: PL4206; Encore: 363291; Exmark: 303146,303283, 303495; Ferris: 1521227; Great Dane: D18037, GDU10231; Husqvarna: 17037, 77344; Jacobsen: 390655; John Deere: AM104490, PL4206; Kees: 77344, 363055, 976450, 363245; Lesco: 050125, 050140; Scag: 48185, 481707, 481711, 482462, 482467, A48108; Snapper: 1-7037; Yazoo: 100341- (2) blades for 36" cut. (3) blades for 52" cut.</p>											
B1PD5008	18"	5/8"	--	--	2-1/2"	.250	Mulching	90-718	6294	303-116	\$22.00
 <p><b>OEM#:</b>Dixie Chopper: 30227-60, 30227-60V, 30227-60H, A30227-50N; Dixon: 9383; Exmark: 613111, 613112, 613250, 633483, 103-2530; Gravely: 46999, 8979651, 8898900, 25124, 8904651- (3) blades for 60" cut.</p>											
B1PD5009	20-1/2"	5/8"	--	--	2-1/2"	.250	Mulching	96-740	6303	302-620	\$24.80
 <p><b>OEM#:</b> Bobcat: 42180B, WM142180B, 112111-03; Bunton: PC005; Ferris: 1520842; Great Dane: C39949, D18036, GDU10232; Husqvarna: 539 10 17-33; Kees: 101733; Lesco: 050170; Scag: 48111, 48304, 482464; Yazoo: 101733- (3) blades for 61" cut.</p>											
B1PD5010	21"	5/8"	--	--	2-1/2"	.250	Mulching	96-702	6299	302-821	\$25.00

Engine oil		
<p><b>Pro Mix Ultra</b> Professional grade 2-cycle engine oil with semi-synthetic formula provides ultimate protection. 1 gallon mix pouch, 48/case.</p> 	<p><b>Pro Mix</b> 2-cycle engine oil formulated to meet TC-3 Spec and reduce formation of deposits and build-up. 1 gallon mix bottle, 48/case.</p> 	<p><b>SAE 30 Oil</b> High detergent SAE 30 4-cycle engine oil with superior oxidation and anti-wear properties. 48 oz. bottle, 6/case.</p> 
<b>B1AC48</b> \$1.00	<b>B1AC240</b> \$1.10	<b>B1AC50</b> \$7.00

Edger Blades By Size

Part Number	Length	CH	OH DIA	C-C	Width	Thick.	Description	Sharpened	Painted	Treat
B1SB6764	6-3/16"	1/2"	--	--	1-1/2"	.095	Straight	Not Sharpened	Black Oxide	Yes
B1SB2662	7"	9/16" D	--	--	1-1/2"	.095	Straight	4 Sides	Black Oxide	Yes
B1SB6172	7-17/32"	7/16"	--	--	1-1/2"	.095	Straight	Not Sharpened	Black Oxide	Yes
B1SB6762	7-1/2"	--	1/4"	--	1-1/2"	.095	Straight	Not Sharpened	Black Oxide	Yes
B1073974	7-11/16"	1"	--	--	2"	.114	Straight	Not Sharpened	Yes	Yes
B1112362	7-11/16"	1"	--	--	2"	.125	Straight	Not Sharpened	Yes	Yes
B1112363	7-11/16"	1"	--	--	2"	.125	Straight	Not Sharpened	No	No
B1SB6276	8"	1"	--	--	8"	.095	4 Edge Star	Not Sharpened	Black Oxide	Yes
B1SB2672	8-9/16"	1/2"	--	--	2"	.095	Straight	Not Sharpened	Black Oxide	Yes
B1SB1145	8-3/4"	1/2"	--	--	2-1/4"	.150	Straight	4 Sides	Black Oxide	Yes
B1SB1137	9"	3/8"	--	--	2"	.117	Angled-Beveled	4 Sides	Black Oxide	Yes
B1SB1141	9"	3/8" D	--	--	1-1/2"	.117	Straight	2 Sides	Black Oxide	Yes
B1SB1138	9"	1/2"	--	--	2"	.117	Angled-Beveled	4 Sides	Black Oxide	Yes
B1SB2671	9"	1/2"	--	--	2"	.095	Straight	Not Sharpened	Black Oxide	Yes
B1SB2658	9"	1/2"	--	--	9"	13 Guage	4 Edge Star	Not Sharpened	Black Oxide	Yes
B1SB1147	9"	1/2"	5/16"	3-1/4"	9"	.090	8 Edge Star	Not Sharpened	Black Oxide	Yes
B1SB1149	9"	1/2"x29/64"	--	--	2"	.117	Angled-Beveled	4 Sides	Black Oxide	Yes
B1SB1139	9"	5/8"	--	--	2"	.117	Angled-Beveled	4 Sides	Black Oxide	Yes
B1SB2661	9"	5/8"	--	--	9"	13 Gauge	4 Edge Star	Not Sharpened	Black Oxide	Yes
B1SB2147	9"	5/8"	5/16"	3-1/4"	9"	.090	8 Edge Star	Not Sharpened	Black Oxide	Yes
B1SB1140	9"	41/64"x3/8" D	--	--	2"	.095	Straight	Not Sharpened	Black Oxide	Yes
B1SB2148	9-1/4"	5/8"	--	--	2-1/2"	.095	Rounded	Not Sharpened	Black Oxide	Yes
B1SB1151	9-13/16"	5/8" D	--	--	2-1/4"	.150	Straight	2 Sides	Black Oxide	Yes
B1SB1148	10"	1/2"	--	--	2"	.117	Straight	4 Sides	Black Oxide	Yes
B1SB2669	12-1/8"	1/2"	--	--	2"	.125	Straight	Not Sharpened	Black Oxide	Yes
B1SB1143	10"	1/2"	--	--	2"	.125	Angled-Beveled	4 Sides	Black Oxide	Yes
B1SB2670	10"	1/2"	--	--	2"	.125	Straight	Not Sharpened	Black Oxide	Yes
B1SB2673	10"	1/2"	--	--	2"	.150	Straight	4 Sides	Black Oxide	Yes
B1SB1150	10"	1/2"x29/64"	--	--	2"	.125	Angled-Beveled	4 Sides	Black Oxide	Yes
B1SB1144	10"	5/8"	--	--	2"	.125	Angled-Beveled	4 Sides	Black Oxide	Yes





## It's important to keep a good blade on your edger.

New blades are more efficient and cause less wear and tear on your equipment. We offer a complete line of replacement edger blades for most manufacturers. We also have many universal blades designed to fit any application. Please see page 337 for a complete list of all our edger blades by size.



### AYP

Jaydee P/N	Length	CH	OH DIA.	C TO C	Width	Thick.	Sharpened	Painted	Heat Treated	Oregon	Rotary	Stens	Price
 <b>OEM #: 85713</b> Fits AYP 4000, 4500, and 79385 edgers. Left-hand cut.													
B1SB2662	7"	9/16" D	--	--	1-1/2"	.095	4 Sides	Black Oxide	Yes	40-907	2662	375-378	\$3.50



### Black & Decker

 <b>OEM #: 82-010</b> Fits Black & Decker U-176 8214.													
B1SB6764	6-3/16"	1/2"	--	--	1-1/2"	.095	No	Black Oxide	Yes	40-120	6764	375-394	\$4.00
 <b>OEM #: 82-024</b> Fits Black & Decker model 8224.													
B1SB6172	7-17/32"	7/16"	--	--	1-1/2"	.095	No	Black Oxide	Yes	40-121	6172	375-410	\$3.70

### Cooper

 <b>OEM #: ED-2</b> Fits Cooper edgers. Double D-shaped center hole.													
B1SB1140	9"	41/64" x 3/8" D	--	--	2"	.095	No	Black Oxide	Yes	40-107	1140	--	\$3.10
 <b>OEM #: --</b> Fits Cooper edgers.													
B1SB2148	9-1/4"	5/8"	--	--	2-1/2"	.095	No	Black Oxide	Yes	40-301	2148	--	\$3.30

### Echo

 <b>OEM #: 720237-001, 69601552631</b> Fits Echo trimmer/edger. Bulk 50-pack.													
B1073974	7-11/16"	1"	--	--	2"	.114	No	Yes	Yes	40-141	6107	375-368	\$48.00
 <b>OEM #: 720237-001, 69601552631</b> Fits Echo trimmer/edger.													
B1112362	7-11/16"	1"	--	--	2"	.125	No	Yes	Yes	40-141	6107	375-368	\$2.00

Replacement Edger Blades

Jaydee P/N	Length	CH	OH DIA.	C TO C	Width	Thick.	Sharpened	Painted	Heat Treated	Oregon	Rotary	Stens	Price
------------	--------	----	---------	--------	-------	--------	-----------	---------	--------------	--------	--------	-------	-------

**Echo**

 <p><b>OEM #: 720237-001. 69601552637</b> Fits Echo timmer/edger.</p>													
B1112363	7-11/16"	1"	--	--	2"	.125	No	No	No	40-140	6477	--	\$2.20

**Green Machine**

 <p><b>OEM #: 237001</b> Fits Green Machine edgers. Bulk 50-pack.</p>													
B1073974	7-11/16"	1"	--	--	2"	.144	No	Yes	Yes	40-141	6107	375-368	\$48.00

 <p><b>OEM #: 237001</b> Fits Green Machine edgers.</p>													
B1112362	7-11/16"	1"	--	--	2"	.125	No	Yes	Yes	40-141	6107	375-368	\$2.00

 <p><b>OEM #: 237001</b> Fits Green Machine edgers.</p>													
B1112363	7-11/16"	1"	--	--	2"	.125	No	No	No	40-140	6477	--	\$2.20

**John Deere**

 <p><b>OEM #: M47147</b> Fits John Deere #2 and #3 edgers.</p>													
B1SB1145	8-3/4"	1/2"	--	--	2-1/4"	.150	4 Sides	Black Oxide	Yes	40-904	1145	--	\$3.50

**Lawn Boy**

 <p><b>OEM #: 603687</b> Fits Lawn Boy edgers.</p>													
B1SB1145	8-3/4"	1/2"	--	--	2-1/4"	.150	4 Sides	Black Oxide	Yes	40-904	1145	--	\$3.50

**Little Wonder**

 <p><b>OEM #: --</b> Fits Little Wonder edgers.</p>													
B1SB1148	10"	1/2"	--	--	2"	.117	4 Sides	Black Oxide	Yes	40-409	1148	375-162	\$3.60

**Maruyama**

 <p><b>OEM #: 216062</b> Fits Maruyama trimmer/edger. Bulk 50-pack.</p>													
B1073974	7-11/16"	1"	--	--	2"	.114	No	Yes	Yes	40-141	6107	375-368	\$48.00

 <p><b>OEM #: 216062</b> Fits Maruyama trimmer/edger.</p>													
B1112362	7-11/16"	1"	--	--	2"	.125	No	Yes	Yes	40-141	6107	375-368	\$2.00



Jaydee P/N	Length	CH	OH DIA.	C TO C	Width	Thick.	Sharpened	Painted	Heat Treated	Oregon	Rotary	Stens	Price
------------	--------	----	---------	--------	-------	--------	-----------	---------	--------------	--------	--------	-------	-------

**Maruyama**



**OEM #: 216062**

Fits Maruyama trimmer/edger.

<b>B1112363</b>	7-11/16"	1"	--	--	2"	.125	No	No	No	40-140	6477	--	\$2.20
-----------------	----------	----	----	----	----	------	----	----	----	--------	------	----	--------

**McCulloch**



**OEM #:301272**

Fits McCulloch edgers. Bulk 50-pack.

<b>B1073974</b>	7-11/16"	1"	--	--	2"	.114	No	Yes	Yes	40-141	6107	375-368	\$48.00
-----------------	----------	----	----	----	----	------	----	-----	-----	--------	------	---------	---------



**OEM #: 301272**

Fits McCulloch edgers.

<b>B1112362</b>	7-11/16"	1"	--	--	2"	.125	No	Yes	Yes	40-141	6107	375-368	\$2.00
-----------------	----------	----	----	----	----	------	----	-----	-----	--------	------	---------	--------



**OEM #: 301272**

Fits McCulloch edgers.

<b>B1112363</b>	7-11/16"	1"	--	--	2"	.125	No	NO	No	40-140	6477	--	\$2.20
-----------------	----------	----	----	----	----	------	----	----	----	--------	------	----	--------

**McLane**



**OEM #: 2059HD**

Fits McLane edgers.

<b>B1SB1145</b>	8-3/4"	1/2"	--	--	2-1/4"	.150	4 Sides	Black Oxide	Yes	40-904	1145	--	\$3.50
-----------------	--------	------	----	----	--------	------	---------	-------------	-----	--------	------	----	--------



**OEM #: 2059-HD-10**

Fits McLane edgers.

<b>B1SB1148</b>	10"	1/2"	--	--	2"	.117	4 Sides	Black Oxide	Yes	40-409	1148	375-162	\$3.60
-----------------	-----	------	----	----	----	------	---------	-------------	-----	--------	------	---------	--------

**MTD**



**OEM #: 781-0080**

Fits MTD 500 and 600 series edgers.

<b>B1SB2148</b>	9-1/4"	5/8"	--	--	2-1/2"	.095	No	Black Oxide	Yes	40-301	2148	--	\$3.30
-----------------	--------	------	----	----	--------	------	----	-------------	-----	--------	------	----	--------

**Paramount**



**OEM #: 534205300**

Fits Paramount models 980-01, 990-00, 1250, 9080E, 9125, E12SBT, E150BT, SE150.

<b>B1SB6762</b>	7-1/2"	--	1/4"	--	1-1/2"	.095	No	Black Oxide	Yes	40-102	6762	--	\$3.00
-----------------	--------	----	------	----	--------	------	----	-------------	-----	--------	------	----	--------

**Safety and your edger blade**

Always wear gloves when handling used edger blades. Even though your edger blade may be dull or worn, it may have very sharp nicks or burrs on it.





Replacement Edger Blades

Jaydee P/N	Length	CH	OH DIA.	C TO C	Width	Thick.	Sharpened	Painted	Heat Treated	Oregon	Rotary	Stens	Price
------------	--------	----	---------	--------	-------	--------	-----------	---------	--------------	--------	--------	-------	-------



**Poulan**

 <b>OEM #: 701557, 92343</b> Fits Poulan 4000, 4500, and 79385 edgers. Left-hand cut.													
B1SB2662	7"	9/16" D	--	--	1-1/2"	.095	4 Sides	Black Oxide	Yes	40-907	2662	375-378	\$3.50

**Power Trim**

 <b>OEM #: --</b> Fits Power Trim 100 series models.													
B1SB2671	9"	1/2"	--	--	2"	.095	No	Black Oxide	Yes	40-130	2671	375-360	\$2.60
 <b>OEM #: --</b> Fits Power Trim 200 and 300 series models.													
B1SB2670	10"	1/2"	--	--	2"	.125	No	Black Oxide	Yes	40-131	2670	375-352	\$2.80
 <b>OEM #: --</b> Fits Power Trim edgers. Golf course application.													
B1SB2669	12-1/8"	1/2"	--	--	2"	.125	No	Black Oxide	Yes	40-132	2669	--	\$3.40

**Ryobi**

 <b>OEM #: 613223</b> Fits Roybi edgers. Bulk 50-pack.													
B1073974	7-11/16"	1"	--	--	2"	.114	No	Yes	Yes	40-141	6107	375-368	\$48.00
 <b>OEM #: 613223</b> Fits Roybi edgers.													
B1112362	7-11/16"	1"	--	--	2"	.125	No	Yes	Yes	40-141	6107	375-368	\$2.00
 <b>OEM #: 613223</b> Fits Roybi edgers.													
B1112363	7-11/16"	1"	--	--	2"	.125	No	No	No	40-140	6477	--	\$2.20

**Sears**

 <b>OEM #: 701557, 92343</b> Fits Sears 79385 edgers. Left-hand cut.													
B1SB2662	7"	9/16" D	--	--	1-1/2"	.095	4 Sides	Black Oxide	Yes	40-907	2662	375-378	\$3.50



**Stihl**

 <b>OEM #: 4133-713-4101</b> Fits Stihl model FC72. Bulk 50-pack.													
B1073974	7-11/16"	1"	--	--	2"	.114	No	Yes	Yes	40-141	6107	375-368	\$48.00



Replacement Edger Blades

Jaydee P/N	Length	CH	OH DIA.	C TO C	Width	Thick.	Sharpened	Painted	Heat Treated	Oregon	Rotary	Stens	Price
------------	--------	----	---------	--------	-------	--------	-----------	---------	--------------	--------	--------	-------	-------

**Stihl**

 <b>OEM #: 4133-713-4101</b> Fits Stihl model FC72.													
<b>B1112362</b>	7-11/16"	1"	--	--	2"	.125	No	Yes	Yes	40-141	6107	375-368	\$2.00
 <b>OEM #: 4133-713-4101</b> Fits Stihl model FC72.													
<b>B1112363</b>	7-11/16"	1"	--	--	2"	.125	No	No	No	40-140	6477	--	\$2.20

**Tanaka**

 <b>OEM #: 435-33110-200</b> Fits Tanaka edgers.													
<b>B1SB1148</b>	10"	1/2"	--	--	2"	.117	4 Sides	Black Oxide	Yes	40-409	1148	375-162	\$3.60
 <b>OEM #: 435-33110200</b> Fits Tanaka 550 edgers.													
<b>B1SB2673</b>	10"	1/2"	--	--	2"	.150	4 Sides	Black Oxide	Yes	40-503	2673	375-162	\$3.60



**Trailmate**

 <b>OEM #:--</b> Fits Trailmate edgers.													
<b>B1SB2148</b>	9-1/4"	5/8"	--	--	2-1/2"	.095	No	Black Oxide	Yes	40-301	2148	--	\$3.40









**Weed Eater**

 <b>OEM #: 701557</b> Fits Weed Eater 4000, 4500, and 79385 edger. Left-hand cut.													
<b>B1SB2662</b>	7"	9/16" D	--	--	1-1/2"	.095	4 Sides	Blck Oxide	Yes	40-907	2662	375-378	\$3.50

**Universal**

 <b>OEM #: AYP: 85713; Poulan 701557, 923743; Weed Eater: 701557</b> Fits AYP, Poulan, Sears, and Weedeater edgers. Left-hand cut.													
<b>B1SB2662</b>	7"	9/16" D	--	--	1-1/2"	.095	4 Sides	Black Oxide	Yes	40-907	2662	375-378	\$3.50
 <b>OEM #: Echo: 720237-001, 69601552631; Green Machine: 237001; Maruyama: 216062; McCulloch: 301272; Ryobi: 613223; Stihl: 4133713-4101</b> Fits Echo, Green Machine, Maruyama, McCulloch, Ryobi, and Stihl edgers. Bulk 50-pack.													
<b>B1073974</b>	7-11/16"	1"	--	--	2"	.114	No	Yes	Yes	40-141	6107	375-368	\$48.00
 <b>OEM #: Echo: 720237-001, 69601552631; Green Machine: 237001; Maruyama: 216062; McCulloch: 301272; Ryobi: 613223; Stihl: 4133713-4101</b> Fits Echo, Green Machine, Maruyama, McCulloch, Ryobi, and Stihl edgers.													
<b>B1112362</b>	7-11/16"	1"	--	--	2"	.125	No	Yes	Yes	40-141	6107	375-368	\$2.00





Replacement Edger Blades

Jaydee P/N	Length	CH	OH DIA.	C TO C	Width	Thick.	Sharpened	Painted	Heat Treated	Oregon	Rotary	Stens	Price
<b>Universal</b>													
		<b>OEM #: Echo: 720237-001, 69601552631; Green Machine: 237001; Maruyama: 216062; McCulloch: 301272; Ryobi: 613223; Stihl: 4133713-4101</b> Fits Echo, Green Machine, Maruyama, McCulloch, Ryobi, and Stihl edgers.											
B1112363	7-11/16"	1"	--	--	2"	.125	No	No	No	40-140	6477	--	\$2.20
		<b>OEM #: --</b> --											
B1SB2672	8-9/16"	1/2"	--	--	2"	.095	No	Black Oxide	Yes	--	2672	--	\$2.90
		<b>OEM #: John Deere: M47147; Lawn Boy: 603687; McLane: 2059HD.</b> Fits John Deere, Lawn Boy, and McLane edgers.											
B1SB1145	8-3/4"	1/2"	--	--	2-1/4"	.150	4 Sides	Black Oxide	Yes	40-904	1145	--	\$3.50
		<b>OEM #: --</b> --											
B1SB1141	9"	3/8" D	--	--	1-1/2"	.117	2 Sides	Black Oxide	Yes	40-901	1141	375-452	\$3.10
		<b>OEM #: MTD: 781-0080</b> Fits Cooper, MTD, Trailmate and others. 3 teeth.											
B1SB2148	9-1/4"	5/8"	--	--	2-1/2"	.095	No	Black Oxide	Yes	40-301	2148	--	\$3.40
		<b>OEM #: --</b> Fits Whipper Clipper, Trailmate, and others.											
B1SB1151	9-13/16"	5/8" D	--	--	2-1/4"	.150	2 Sides	Black Oxide	Yes	--	1151	--	\$3.40
		<b>OEM #: McLane: 2059-HD-10; Tanaka: 435-33110-200</b> Fits Little Wonder, McLane, and Tanaka edgers.											
B1SB1148	10"	1/2"	--	--	2"	.117	4 Sides	Black Oxide	Yes	40-409	1148	375-162	\$3.60
<b>Angled-Beveled Blade</b>													
													
B1SB1137	9"	3/8"	--	--	2"	.117	4 Sides	Black Oxide	Yes	40-408	1137	--	\$3.10
													
B1SB1138	9"	1/2"	--	--	2"	.117	4 Sides	Black Oxide	Yes	40-402	1138	375-014	\$3.10

Replacement Edger Blades



Jaydee P/N	Length	CH	OH DIA.	C TO C	Width	Thick.	Sharpened	Painted	Heat Treated	Oregon	Rotary	Stens	Price
------------	--------	----	---------	--------	-------	--------	-----------	---------	--------------	--------	--------	-------	-------

**Angled-Beveled Blade**

													
B1SB1149	9"	1/2" x 29/64"	--	--	2"	.117	4 Sides	Black Oxide	Yes	--	1149	375-089	\$3.10
													
B1SB1139	9"	5/8"	--	--	2"	.117	4 Sides	Black Oxide	Yes	40-411	1139	375-071	\$3.10
													
B1SB1143	10"	1/2"	--	--	2"	.125	4 Sides	Black Oxide	Yes	40-403	1143	375-022	\$3.10
													
B1SB1150	10"	1/2" x 29/64"	--	--	2"	.125	4 Sides	Black Oxide	Yes	40-405	1150	--	\$3.40
													
B1SB1144	10"	5/8"	--	--	2"	.125	4 Sides	Black Oxide	Yes	40-404	1144	375-105	\$3.10

**Star Shaped Blades**





**Jacobsen**

 <p><b>OEM #: 309444</b> Fits Jacobsen edgers.</p>													
B1SB1147	9"	1/2"	5/16"	3-1/4"	9"	.090	No	Black Oxide	Yes	40-807	1147	375-048	\$11.00
 <p><b>OEM #: --</b> Fits Jacobsen edgers.</p>													
B1SB2147	9"	5/8"	5/16"	3-1/4"	9"	.090	No	Black Oxide	Yes	40-804	2147	--	\$11.00

**Universal**

 <p><b>OEM #: --</b> Fits K&amp;K, King-O-Lawn, McLane, Power Trim and others. Shape prevents clogging.</p>													
B1SB6276	8"	1"	--	--	8"	.095	No	Black Oxide	Yes	40-840	6276	375-525	\$5.60

Replacement Edger Blades

Jaydee P/N	Length	CH	OH DIA.	C TO C	Width	Thick.	Sharpened	Painted	Heat Treated	Oregon	Rotary	Stens	Price	
<b>Universal</b>														
 <p><b>OEM #: --</b> Fits K&amp;K, King-O-Lawn, McLane, Power Trim and others. Shape prevents clogging.</p>														
<b>B1SB2658</b>	9"	1/2"	--	--	9"	.000	No		Black Oxide	Yes	40-843	2658	375-311	\$8.20
 <p><b>OEM #: --</b> Fits K&amp;K, King-O-Lawn, McLane, Power Trim and others. Shape prevents clogging.</p>														
<b>B1SB2661</b>	9"	5/8"	--	--	9"	.000	No		Black Oxide	Yes	40-845	2661	375-485	\$8.20
<b>Edger Shaft</b>														
<b>McLane</b>														
 <p><b>OEM#: 2033</b> 5/8" x 4-7/8" shaft with 2-1/4" pulley.</p>														
<b>B1SB1248</b>	--	--	--	--	--	--	--	--	--	--	41-478	1248	376-046	\$19.90
<b>Aerator Tine</b>														
<b>Universal</b>														
 <p><b>OEM#: Bluebird: 7190; Ryan: 522361; Turfco: 87305</b> Aerator tine. 1/2" closed spoon. Fits Bluebird 424, 530A, and 742; Ryan Lawnaire IV.</p>														
<b>B1CO128</b>	--	3/4"	.900	--	--	--	--	--	--	--	89-001	12714	373-017	\$5.10





Product No.	OEM Manufacturer	Dimensions	Application	Oregon	Rotary	Stens	Price
<b>B1SB2784B</b>	AYP: 63087A, 10096; Tecumseh: 35066	1-3/4" OD x 7/8" ID x 2-7/8" H	Bulk package of B1SB2784 (40).	30-301	2784	100-2222	\$75.00
<b>B1AF123B</b>	Briggs & Stratton: 493909, 496894, 496894S	7-1/4" L x 2-7/8" W wide end, 2-3/16" W narrow end x 3" H	Bulk package of B1AF132 (24). Includes B1SB7095 Prefilter.	30-049	7094	100-085	\$230.00
<b>B1AF211B</b>	Briggs & Stratton: 697153, 697634, 697776, 698083, 795115	7-1/8" L x 3-3/16" W x 1-1/2" H	Bulk package of B1AF211 (24). Includes B1AF210 Prefilter.	30-704	10184	102-875	\$170.00
<b>B1SB2838B</b>	Briggs & Stratton: 399959, 491588	5-1/4" L x 4-1/2" W x 3/4" H	Bulk Package of B1SB2838 (60).	30-710	2838	102-549	\$170.00
<b>B1SB6524B</b>	Briggs & Stratton: 272235	5-3/4" L x 3-5/8" W x 1-1/4" H	Bulk package of B1SB6524 (24).	30-046	6254	102-525	\$60.00
<b>B1AF201B</b>	Briggs & Stratton: 821136; John Deere: M131803, M144098; Kawasaki: 11013- 7019; Kohler: 25 083 04	--	Bulk package of B1AF201 (12).	30-056	9728	055-165	\$190.00
<b>B1AF204B</b>	Briggs & Stratton: 841497; Generac: 0E3557; John Deere: M131802. M144100; Kawasaki: 11013-7029; Kohler: 25 083 01	4" OD x 2-13/32" ID x 10-1/2" H	Bulk package of B1AF204 (12).	30-055	9583	102-305	\$188.00
<b>B1AF208B</b>	Honda: 17211-ZL8-000, 5580402	5-1/2" L x 4-1/2" W x 3-1/4" H	Bulk package of B1AF208 (60).	30-347	9953	102-713	\$180.00
<b>B1AF84B</b>	Honda: 17210-ZE1-821, 17210- ZE1-822, 17210-ZE1-820, 17210-ZE1-505, 17210-ZE1-517	4" L x 2-7/8" W x 2- 3/4" H	Bulk package of B1AF84 (30). Includes prefilter.	30-404	6690	100-784	\$205.00

Replacement Air Filters



Product No.	OEM Manufacturer	Dimensions	Application	Oregon	Rotary	Stens	Price
<b>B1AF171B</b>	Kawasaki: 11013-7002	8-5/16" L x 3-13/16" W x 1-3/16" H; 6-7/16" W with tab; filter and lip 6-1/2" W	Bulk package of B1AF171 (24). Includes B1AF173 Prefilter.	30-322	9506	100-160	\$245.70
<b>B105137B</b>	Tecumseh: 36905	2-3/4" L x 1-3/4" W x 2-7/8" H	Bulk package of B105137 (30).	30-031	9200	100-812	\$104.50

**Related Products**

**Bel Ray Foam Filter Spray Oil**

Bel-Ray Foam Filter Oil's new and improved formula is ultra-viscous for the highest levels of engine protection and fast-drying for more convenient maintenance. It creates a highly tacky barrier for superior filtration without restricting air flow. Able to trap micron-sized, airborne particles that can cause engine damage and performs exceptionally well in dusty environments. Bel-Ray Foam Filter Oil is waterproof, so it will not wash off, clog or gum up when the filter gets wet. Delivers all of the performance benefits of Bel-Ray's pour type oil in an environmentally friendly aerosol package.



**B1AF2** \$21.00





**GoJo Hand Cleaner**

Heavy-duty hand cleaner meets all of the needs of anyone who gets their hands dirty. Crème formula with orange citrus ingredients and natural pumice scrubbers. For removing grease, tar and oil. Use with or without water. 14 oz. 12/case.







**B1GJ14** \$5.00



**Ariens**

	Dimension	Use With	Oregon	Rotary	Stens	Price
	<b>B1AF204</b> 21536900, 21537000, 21538600 - Fits heavy duty engines with remote air canister.					
	4" OD x 2-13/32" ID x 10-1/2" H	Inner Filter - B1AF204 (12),	30-055	9583	102-305	\$21.10
	<b>B1AF204B</b> 21536900, 21537000, 21538600 - Bulk package of B1AF204 (12).					
	4" OD x 2-13/32" ID x 10-1/2" H	--	30-055	9583	102-305	\$198.00
	<b>B1AF201</b> 21536900, 21538700 - Inner filter					
	--	Filter - B1AF204	30-056	9728	100-780	\$21.70
	<b>B1AF201B</b> 21536900, 21538700 - Bulk package of B1AF201 (12).					
	--	--	30-056	9728	055-165	\$198.00

**Bad Boy**



	Dimension	Use With	Oregon	Rotary	Stens	Price
	<b>B1AF204</b> 063-8019-00 - Fits heavy duty engines with remote air canister.					
	4" OD x 2-13/32" ID x 10-1/2" H	Inner Filter - B1AF204 (12).	30-055	9583	102-305	\$21.10
	<b>B1AF204B</b> 063-8019-00 Bulk package of B1AF204 (12).					
	4" OD x 2-13/32" ID x 10-1/2" H	--	30-055	9583	102-305	\$198.00
	<b>B1AF201</b> 063-8020-00 Inner filter.					
	--	Filter-B1AF204	30-056	9728	100-780	\$21.70
	<b>B1AF201B</b> 063-8020-00 Bulk package of B1AF201 (12).					
	--	--	30-056	9728	055-165	\$198.00

**Bobcat**

	Dimension	Use With	Oregon	Rotary	Stens	Price
	<b>B1AF204</b> 4114746 Fits heavy duty engines with remote air canister.					
	4" OD x 2-13/32 ID x 10-1/2" H	Inner Filter -B1AF201	30-055	9583	102-305	\$21.10
	<b>B1AF204B</b> 4114746 Bulk package of B1AF204 (12).					
	4" OD x 2-13/32" ID x 10-1/2" H	--	30-055	9583	102-305	\$198.00

Replacement Air Filters

**Bobcat**

	Dimension	Use With	Oregon	Rotary	Stens	Price
	<b>B1AF201</b> <b>4114747, 6669548, 6672468</b> Inner filter.					
	--	Filter-B1AF204	30-056	9728	100-780	\$21.70
	<b>B1AF201B</b> <b>4114747, 6669548, 6672468</b> Bulk package of B1AF201 (12).					
	--	--	30-056	9728	055-165	\$206.40

**Briggs & Stratton**

	Dimension	Use With	Oregon	Rotary	Stens	Price
	<b>B1AF215</b> <b>692446</b> Fits models 123602, 123607, 123672. Fits Intek Pro 5, 5.5, 6, 6.5 HP.					
	3-3/4" L x 2-3/8" W x 3-1/8" H	Prefilter-B1AF179	30-039	9591	100-871	\$8.60
	<b>B1AF179</b> <b>273356</b> Prefilter					
	--	Filter-B1AF215	--	9592	102-091	\$1.70
	<b>B1SB1374 - 390930, 393957, 393957S</b> Fits models 170400, 171400, 190400, 195400, 220400, 221400, 222400, 233400, 243400, 252400, 253700, 254400, 290400, 294400, 302400, 303400, 326400. Fits 7 thru 18 HP horizontal engines.					
	4-1/4" OD x 2" ID x 3-3/4" H	Prefilter-B1SB2786	30-044	1374	100-073	\$5.80
	<b>B1SB2786</b> <b>270782, 271794, 271794S</b> - Prefilter					
	--	Filter-B1SB1374	30-920	2786	100-685	\$3.80
	<b>B1SB2773</b> <b>390492, 496047</b> - Fits models 146400, 170400, 171400, 190400. For 6 thru 8 HP horizontal engines.					
	3-3/4" OD x 1-3/8" ID x 2-7/8" H	--	30-097	2773	100-099	\$4.50
	<b>B1SB2788 - 396424, 396424S</b> Fits models 60100, 80200, 80300, 80400, 81200, 81300, 81400, 82200, 82300, 82400, 92500, 92900, 110900, 111700, 112200, 112900, 114700, 114900, 130200, 130400, 130900, 131200, 131400, 131900, 132200, 132400, 132900. For 2 thru 5 HP engines.					
	2-3/4" OD x 1-1/4" ID x 2-3/4" H	Prefilter-B1SB1369	30-094	2788	100-214	\$5.20
	<b>B1SB1369</b> <b>270979, 271466</b> Prefilter.					
	--	Filter-B1SB2788	30-923	1369	100-669	\$1.50
	<b>B1AF135</b> <b>497725, 494586, 497725S</b> Fits models 99700, for 9 CID vertical OHV Europa engines. Also fits 5 HP Quantum engines models 12U800 thru 12U899.					
	3-3/4" L x 2-1/2" W x 2-1/8" H	Prefilter-B1SB8490	30-047	8815	100-184	\$6.60



**Briggs & Stratton**

	Dimension	Use With	Oregon	Rotary	Stens	Price
	<b>B1AF8490</b> <b>272533, 273185, 27+D148S</b> Prefilter					
	--	Filter-B1AF135	30-930	8490	100-192	\$1.30
	<b>B1AF132</b> <b>493909, 496894, 496894S</b> Fits models 282700, 283700, 286700, 287700, 28M700, 28N700, 28P700, 28Q700, 28R700, 28T700, 28U700, 289700. For 12.5 thru 15HP vertical engines.					
	7-1/4" L x 2-7/8" W wide end, 2-3/16" W narrow end x 3" H.	Air Cleaner Nut -	30-049	7094	100-085	\$15.30
	<b>B1AF132B</b> <b>493909, 496894, 496894S</b> Bulk package of B1AF132 (24). Includes B1SB7095 Prefilter.					
	7-1/4" L x 2-7/8"W wide end, 2-3/16" W narrow end x 3" H.	--	30-049	7094	100-085	\$242.40
	<b>B1SB7095</b> <b>272403, 272403S</b> Prefilter					
	--	Filter-B1AF132	30-925	7095	100-219	\$1.60
	<b>B1SB7778</b> <b>281051, 692297</b> Air Filter Nut. Comes with washer and rubber O-Ring attached. 1/4-20 THD. Built in rubber seal.					
	--	Filter-B1AF132	--	7778	--	\$0.90
	<b>B1SB1396 - 392308, 392308S</b> Fits models 60100, 80200, 80300, 80400, 81200, 81300, 81400, 92900, 93500, 110900, 112200, 130200, 130400, 130900, 131200, 131400, 131900. For 2 thru 5 HP vertical and horizontal engines.					
	2-3/4" OD x 1-1/4" ID x 2-3/4" H	Prefilter-B1SB1369	30-132	1396	100-081	\$4.30
	<b>B1SB1369</b> <b>270979, 271466</b> Prefilter					
	--	Filter-B1SB1396	30-923	1369	100-669	\$1.50
	<b>B1AF172</b> <b>498596, 690610, 690029, 697029</b> Fits Intek Pro 5.5 and 6.5 HP engines 111600 and 121600 series.					
	3-9/16" L x 2-1/4" W x 3" H	Plug-B1AF172P, Prefilter-B1AF179	30-033	9168	100-093	\$6.50
	<b>B1AF179</b> <b>273356</b> Prefilter					
	--	Filter-B1AF172, Plug-B1AF172P	--	9592	102-091	\$1.70
	<b>B1SB7214</b> <b>493910, 496864, 691667</b> Fits models 196700, 257700, 259700. For 8.5, 10.5 and 11.5 HP vertical engines.					
	7-1/4" L x 2-7/8" W wide end, 2-3/16" W narrow end x 2-3/8" H	Prefilter-B1AF105	30-048	7214	100-089	\$12.60

Replacement Air Filters

**Briggs & Stratton**

	Dimension	Use With	Oregon	Rotary	Stens	Price
	<b>B1AF105</b> <b>272477</b> Prefilter					
	--	Filter-B1SB7214	30-926	7949	100-219	\$1.90
	<b>B1SB2777 - 392642, 394018</b> Fits models 290000, 290400, 290700, 294000, 294400, 294700, 303400, 303700, 303900, 392642, 394018 400400 thru 422400, 350700, 350400, 351400. For L-Head Twin horizontal and all vertical V-Twin OHV Vanguard Engines.					
	7" OD x 5-5/8" ID x 2-1/8" H	Prefilter-B1SB2797	30-101	2777	100-131	\$5.40
	<b>B1SB2797</b> <b>271271, 272490</b> Prefilter					
	--	Filter-B1SB2777	30-929	2797	100-743	\$3.50
	<b>B1SB2806</b> <b>394019</b> Fits models 400700 thru 422700, 40A700, 42A700, 460700. For 16 and 18 HP vertical twin (L-Head) cylinder engines.					
	9-5/8" L x 4" W x 2-1/2" H	Prefilter-B1SB2797	30-104	2806	100-164	\$8.80
	<b>B1SB2797</b> <b>271271, 272490</b> Prefilter.					
	--	Filter-B1SB2806	30-929	2797	100-743	\$3.50
	<b>B1SB5941</b> <b>399806, 491519</b> Fits models 253700, 256700, 280700, 281700. For 10 thru 12 HP IC vertical engines.					
	8-5/8" L x 2-5/8" W x 2-3/4" H	Prefilter-B1SB5939	30-107	5941	100-891	\$9.60
	<b>B1SB5939</b> <b>271962</b> Prefilter					
	--	Filter-B1SB5941	30-924	5939	100-842	\$1.50
	<b>B1AF85</b> <b>399968</b> Fits 7, 8, 11 HP horizontal engines.					
	8-3/4" L x 3-1/4" W x 2-1/2" H	Prefilter-B1AF87	30-108	7879	102-910	\$10.10
	<b>B1AF87</b> <b>271939</b> - Prefilter					
	--	Filter-B1AF85	--	10105	--	\$2.40
	<b>B1SB2778</b> <b>393720, 393725</b> Fits models 220700, 252700, 253700, 256700. For 11 HP IC vertical engines.					
	5-3/16" L x 3" W x 2-1/2" H	--	30-105	2778	100-198	\$5.40
	<b>B1SB2840</b> <b>393406</b> Fits models 170700, 190700, 191700, 192700, 193700 series. For 7 and 8 HP vertical engines.					
	5-3/16" L x 3-1/8" W x 2-1/8" H	--	30-106	2840	100-487	\$5.60









**Briggs & Stratton**

	Dimension	Use With	Oregon	Rotary	Stens	Price
 <p><b>B1SB6514</b> <b>392286</b> Fits models 251400 thru 255400. For 10, 11, and 12 HP vertical engines.</p>	5" OD x 3-1/2" ID x 2-3/8" H	--	30-022	6514	--	\$5.20
 <p><b>B1SB6604</b> <b>491021</b> Fits models 260700, 261700. For 12.5 and 14 HP vertical single cylinder, OHV Vanguard engines.</p>	6-3/4" L x 3" W x 3-1/8" H	Prefilter-B1SB6575	30-134	6604	100-800	\$9.50
 <p><b>B1SB6575</b> <b>492947</b> Prefilter</p>	--	Filter-B1SB6604	--	6575	102-103	\$1.30
 <p><b>B1SB6602</b> <b>491950</b> Fits models 104700 series. For 5 HP vertical OHV Vanguard engines. Types 3112, 4024, 4025 4044, 4445.</p>	5-1/2" L x 2-1/2" W x 2-3/4" H	Prefilter-B1SB6603	--	6602	102-914	\$13.10
 <p><b>B1SB6603</b> <b>493206, 272218</b> Prefilter</p>	--	Filter-B1SB6602	--	6603	102-129	\$1.40
 <p><b>B1SB7880</b> <b>496077, 691643</b> Fits 8 HP Industrial Plus engines.</p>	7" L x 3-1/2" W x 1-1/2" H	Prefilter-B1AF130	30-028	7880	102-230	\$8.60
 <p><b>B1AF130</b> <b>492889</b> Prefilter</p>	--	Filter-B1SB7880	30-928	8483	100-234	\$2.30
 <p><b>B1SB7877</b> <b>494511</b> Fits model 133400 series 5 HP Industrial Plus engines.</p>	7" L x 3-1/2" W x 1-1/4" H	Prefilter-B1AF130	30-735	7877	102-024	\$6.30
 <p><b>B1AF130</b> <b>492889</b> Prefilter</p>	--	Filter-B1SB7877	30-928	8483	100-234	\$2.30
 <p><b>B1SB2841</b> <b>399877</b> Fits model 100700. For 3.5 HP Quantum (side starter style) engines.</p>	4-5/8" L x 4-5/8" W x 7/8" H	--	30-720	2841	102-541	\$5.00
 <p><b>B1AF211</b> <b>697153, 697634, 697776, 698083, 795115</b> Models 210000 &amp; 310000. Fits Intek 21 &amp; 31 CID vertical shaft AVS (Anti Vibration System) Engines.</p>	9" L x 3-1/8" W x 1-1/2" H	Prefilter-B1AF210	30-074	10184	102-875	\$7.80

Replacement Air Filters

**Briggs & Stratton**











	Dimension	Use With	Oregon	Rotary	Stens	Price
 <p><b>B1AF211B</b> 697153, 697634, 697776, 698083, 795115 Bulk package of B1AF211 (24). Includes B1AF210 Prefilter.</p>	9" L x 3-1/8" W x 1-1/2" H	--	30-074	10184	102-875	\$175.20
	<p><b>B1AF210</b> 697015 Prefilter.</p>					
 <p><b>B1AF252</b> 697153, 795115, 5078D, 5077H Fits 28, 30, 31 CID engines. Delivers up to 4 times the life of a standard paper element air filter. Heavy Duty.</p>	9" L x 3-1/8" W x 1-1/2" H	Prefilter-B1AF210	30-122	12964	102-875	\$14.10
	<p><b>B1AF210</b> 697015 Prefilter</p>					
 <p><b>B1AF213</b> 697152, 698413 Fits models 21A900 and 21B900 series. Fits OHV 10 HP engines.</p>	7-1/4" L x 3-1/8" W x 1-1/2" H	Prefilter-B1AF216	30-073	10263	100-640	\$7.50
	<p><b>B1AF216</b> 697292 Prefilter</p>					
 <p><b>B1AF106</b> 710265 Panel filter for 4 HP horizontal Vanguard engines.</p>	6-1/4" L x 3-1/2" W x 7/8" H	--	30-761	9167	102-028	\$9.30
	<p><b>B1AF107</b> 710266 Panel filter for 9 HP Vanguard engine. Fits model 185400.</p>					
 <p><b>B1SB6586</b> 491384 Fits 161400 series models. For 9 HP 16 CID OHV Vanguard engines.</p>	7" L x 3-1/2" W x 1-1/2" H	Prefilter-B1AF130	30-731	6586	102-020	\$7.20
	<p><b>B1AF130</b> 492889 Prefilter</p>					
 <p><b>B1SB2838 - 399959, 491588</b> Fits models 80200, 82200, 112200, 121000, 834000, 121700, 121800, 122700, 123700, 123800, 124700, 124800, 126700, 126800, 125700, 128000, 130200, 132200, 135298. For 3.5 and 6 HP Quantum, 3 and 5 HP IC horizontal, top starter.</p>	5-1/4" L x 4-1/2" W x 3/4" H	Prefilter-B1AF81	30-710	2838	102-549	\$4.40

**Briggs & Stratton**











	Dimension	Use With	Oregon	Rotary	Stens	Price
 <p><b>B1SB2838B</b>  <b>399959, 491588</b> Bulk package of B1SB2838 (60).</p>	5-1/4" L x 4-1/2" W x 3/4" H	--	30-710	2838	102-549	\$174.00
 <p><b>B1AF81</b>  <b>271933, 491435</b> Prefilter</p>	--	Filter-B1SB2838	30-927	8481	100-446	\$3.30
 <p><b>B1SB2789</b>  <b>397795</b> Fits models 90700, 91700, 95700, 96700, 110700, 111700, 112700, 114700, 130700, 131700                      For 3.5 and 4 HP Max series, also used on 4-5 HP 9 CID 2 cycle engines.</p>	6-5/16" L x 4-1/2" W x 3/4" H	Prefilter-B1AF131	30-700	2789	102-533	\$4.70
 <p><b>B1AF131</b>  <b>399039</b> Prefilter</p>	--	Filter-B1SB2789	30-038	8242	100-226	\$2.50
 <p><b>B1SB6601</b>  <b>805113</b> Fits 290400, 290700, 294400, 294700, 303400, 303700 series 12.5, 14 and 16 HP horizontal &amp; vertical V-twin OHV Vanguard engines.</p>	7-3/8" L x 6-5/16" W x 3/4" H	Prefilter-B1AF138	30-736	6601	100-887	\$10.30
 <p><b>B1AF138</b>  <b>805267</b> Prefilter</p>	--	Filter-B1SB6601	--	8480	100-879	\$3.10
 <p><b>B1AF113</b>  <b>499486, 672472, 698754, 792101</b> Fits Intek V-twin OHV engines 14 thru 24 HP.</p>	7" L x 4" W x 1-1/2" H	Prefilter-B1AF104	30-032	9273	100-153	\$8.40
 <p><b>B1AF104</b>  <b>273638S</b> Prefilter</p>	--	Filter-B1AF113	--	9304	100-176	\$2.80
 <p><b>B1AF204</b>  <b>4235, 841497</b> Fits heavy duty engines with remote air canister.</p>	4" OD x 2-13/32" ID x 10-1/2" H	Inner Filter-B1AF201	30-055	9583	102-305	\$21.10
 <p><b>B1AF204B</b>  <b>4235, 841497</b> Bulk package of B1AF204 (12).</p>	4" OD x 2-13/32" ID x 10-1/2" H	--	30-055	9583	102-305	\$198.00
 <p><b>B1AF201</b>  <b>4236, 821136</b> Inner filter.</p>	--	Filter-B1AF204	30-056	9728	100-780	\$21.70

Replacement Air Filters

**Briggs & Stratton**







	Dimension	Use With	Oregon	Rotary	Stens	Price
 <p><b>B1AF201B</b>  <b>4236, 821136</b> Bulk package of B1AF201 (12).</p>	--	--	30-056	9728	055-165	\$206.40
 <p><b>B1AF244</b>  <b>820263</b> Primary air filter</p>	3-1/2" OD x 1-27/32" ID x 7-1/4" H	Inner Filter-B1AF243	--	9550, 11842	100-533	\$13.10
 <p><b>B1AF243</b>                      Inner filter. Fits Engineaire and Kohler CH22-66557, TH16-52527. Replaces Kohler 25 083 03S.</p>	--	Filter-B1AF244	--	--	100-541	\$9.20
 <p><b>B1AF164</b>  <b>793569, 793865</b> Fits models 31L777, 31M977, 31Q777, 331707, 331777, 331807, 331877, 33M677, 33M777. Fits ELS (Extended Life Series) with 17.5 HP, 18.5 HP, and 21 HP. Includes prefilter.</p>	2-15/16" L x 2-15/16" W x 5-7/8" H	--	--	--	100-929	\$13.60
 <p><b>B1AF294</b>  <b>796031</b> Fits Intek engines.</p>	--	--	--	--	--	\$6.56
 <p><b>B1AF166</b>  <b>792105, 792303, 276890</b> Fits models 407777, 40G777, 40H777, 44H777, HHK777, 44L777, 44M777, 44P777, 44Q777. ELS V=Twinn (Extended Life Series) with 16-27 HP. Includes prefilter.</p>	5-1/8" L x 3-1/4" W x 4-5/8" H	--	30-145	12282, 12283	102-008	\$16.50
 <p><b>B1AF320</b>  <b>698867, 790166</b> Fits newer model 9.</p>	3" L x 2" W x 2" H	--	--	12080	100-834	\$8.70
 <p><b>B1AF321</b>  <b>792038, 790388</b> Fits DOV mower engines. Includes prefilter.</p>	--	--	--	--	100-913	\$13.60
 <p><b>B1AF266</b>  <b>692519</b> Fits Twin Cylinder Vanguard engines model 358700-389400</p>	7-13/16" OD x 5-1/2" ID x 2-1/4" H	Prefilter-B1SB7050	30-087	11795	102-119	\$11.00
 <p><b>B1SB7050</b>  <b>692520</b> Prefilter. Replaces Onan 140-1496.</p>	--	Filter-B1AF266	30-011	7050	100-875	\$2.80
 <p><b>B1AF251</b>  <b>794071</b> Fits 120T00, 400-500 series vertical shaft engines.</p>	4-1/2" L x 4" W x 1-1/4" Thick		--	12272	102-847	\$2.30

## Briggs &amp; Stratton





	Dimension	Use With	Oregon	Rotary	Stens	Price
	<b>B1AF253</b> <b>711459</b> Fits 2-4 HP Vanguard engines.					
	--	--	--	12886	--	\$7.00
	<b>B1AF258</b> <b>792038, 790388</b> Tri-oval filter fits DOV engines.					
	--	Prefilter-B1AF267	--	12877	100-913	\$6.60
	<b>B1AF267</b> <b>793676</b> Prefilter - fits DOV mower engines, 100602 & 100800.					
	--	Filter-B1AF258	--	12895	--	\$2.20
	<b>B1AF259</b> <b>795066, 796254</b> Fits models 110000, 120000 series 775, 850/875. Fits DOV engines.					
	--	--	--	12968	100-673	\$9.50
	<b>B1SB6524</b> <b>272235</b> Fits models 92500, 92900, 93900, 95900, 96000, 96500, 96900. For 3, 3.5 and 3.75 HP Sprint and Classic vertical engines after 1992.					
	5-3/4" L x 3-5/8" W x 1-1/4" H	--	30-046	6254	102-525	\$3.10
	<b>B1SB6524B</b> <b>272235</b> Bulk package of B1SB6524 (24).					
	5-3/4" L x 3-5/8" W x 1-1/4" H	--	30-046	6254	102-525	\$57.60
	<b>B1SB1371</b> <b>270579</b> Fits models 82500 to 82997, 92000 thru 93500. For 3 and 3.5 HP automatic choke vertical engines prior to 1992. Used after code 6808011.					
	4-1/2" to 5-3/8" L x 3" W x 1" H	--	30-041	1371	100-529	\$4.60
	<b>B1SB7051</b> <b>272405, 272922</b> Fits models 194700 and 195700 series 8 HP horizontal engines.					
	8-1/8" L x 2-3/4" ID x 3-3/16" H	--	--	7051	102-863	\$6.20
	<b>B1AF97</b> <b>270093</b> Fits 190400, 300400, 320400. For 7 thru 14 HP early style engines.					
	4-3/4" OD x 1-5/16" ID x 3-3/16" H	--	--	--	102-194	\$5.90
	<b>B1SB1398</b> <b>270848</b> Fits models 110900, 111900, 112900, 113900, 114900. For 4 HP automatic choke vertical engines.					
	4-3/4" to 5-1/2" L x 3-1/4" to 4" W x 1-1/2" H	--	30-202	1398	100-503	\$4.60
	<b>B1SB1370</b> <b>27987</b> Fits models 60000 to 80000, 100200, 111200, 130200, 131200, 140200. For 2 thru 5 HP horizontal engines.					
	4-5/8" to 5-1/4" L x 3-5/8" to 4-1/4" W x 1-1/2" H	--	30-040	1370	100-511	\$5.00

Replacement Air Filters

**Briggs & Stratton**





	Dimension	Use With	Oregon	Rotary	Stens	Price
	<b>B1SB1376</b> <b>270067</b> Fits 100900 series. For 4 HP vertical engines.					
	5" to 5-5/8" L x 3" to 3-5/8" W x 1-1/2" H	--	30-200	1376	100-578	\$2.90
	<b>B1SB1372</b> <b>270251</b> Fits models 82000, 92000 before code 6808011, 82500 thru 92900, 92500 series. For 3 and 3.5 HP without automatic choke.					
	5" to 5-3/4" L x 2-7/8" to 3-5/8" W x 1-1/2" H	--	30-042	1372	100-537	\$5.00
	<b>B1SB1397</b> <b>270843</b> Fits models 251700, 252700, 220700. For 10 and 11 HP vertical engines.					
	9-1/2" L x 4-9/16" W x 1-1/2" H	--	30-099	1397	100-560	\$3.80
	<b>B1SB1373</b> <b>270528</b> Fits models 146700 thru 147703, 170700, 171700, 190700, 191700, 192700, 193700, series. For 7 and 8 HP vertical engines.					
	7-3/4" to 8-1/4" L x 3-5/8" to 4-1/4" W x 1-1/2" H	--	30-043	1373	100-545	\$7.00
	<b>B1SB1375</b> <b>270447</b> Fits 130900 series. For 5 HP vertical engines.					
	5-3/8" to 6" L x 3" to 3-5/8" W x 1-1/2" H	--	30-203	1375	100-552	\$3.10
	<b>B1AF133</b> <b>4216, 5088, 5088H, 5099, 698369</b> Fits 10A900, 98900, 9B900 and 9C900 series after code 02101000. For most 3.5-4.5 HP Q45, Classic, Sprint™, Quattro™ engines with Plastic Air Cleaner Housing.					
	5-1/8" L x 2-7/8" W x 1-1/4" H	--	30-919	11547	100-632	\$3.20

**Case**



	Dimension	Use With	Oregon	Rotary	Stens	Price
	<b>B1AF204</b> <b>86401594, 87300178, 8300179</b> Fits heavy duty engines with remote air canister.					
	4" OD x 2-13/32" ID x 10-1/2" H	Inner Filter-B1AF201	30-055	9583	102-305	\$21.10
	<b>B1AF204B</b> <b>86401594, 87300178, 8300179</b> Bulk package of B1AF204 (12).					
	4" OD x 2-13/32" ID x 10-1/2" H	--	30-055	9583	102-305	\$198.00
	<b>B1AF201</b> Inner filter					
	--	Filter-B1AF204	30-056	9728	100-780	\$21.70
	<b>B1AF201B</b> Bulk package of B1AF201 (12).					
	--	--	30-056	9728	055-165	\$206.40



**Case**

	Dimension	Use With	Oregon	Rotary	Stens	Price
 <p><b>B1SB1388</b> Fits Kohler models K341, K321, K482, K532, KT17, KT19, MV16 thru 20, M10 thru M20, CV18 thru CV- 22. Fits Onan models BF, BFA, BG, BGA, B43, B48. For 16 and 18 HP engines. Replaces Kohler 45 083 02; Onan 140-1216</p>	6" OD x 4-5/8" ID x 3" H	Prefilter-B1SB2844	30-093	1388	100-065	\$5.90
	 <p><b>B1SB2844</b> <b>C-2045</b> Prefilter. Replaces Kohler 56 083 01; Onan 140-1218</p>					
 <p><b>B1SB1386</b> <b>A70090, C-28883</b> - Fits Tecumseh models OH120 thru 175, HH100-115, HH80-120 and VH100-149. For 8 thru 16 HP horizontal engines. Fits Kohler models K241, K301, K321. For 10, 12, 14 HP engines. Replaces Techumseh 32008; Kohler 235116.</p>	6" OD x 4-5/8" ID x 1-7/8" H	Prefilter-B1SB1377	30-080	1386	100-040	\$4.40
	 <p><b>B1SB1377</b> Prefilter. Replaces Kohler 237421; Tecumseh 32906</p>					
						\$2.00



**Clinton**

	Dimension	Use With	Oregon	Rotary	Stens	Price
 <p><b>B1SB1384</b> <b>002-0233-00</b> Replaces Kohler 230840; Tecumseh 30804.</p>	4-3/8" OD x 3-1/2" ID x 1-1/2" H	Prefilter-B1SB5934	30-081	1384	100-024	\$3.70
	 <p><b>B1SB5934</b> Prefilter</p>					
						\$2.00

**Columbia**



	Dimension	Use With	Oregon	Rotary	Stens	Price
 <p><b>B1AF102</b> <b>291131-71</b> Replaces Wisconsin L0188</p>	4-1/4" OD x 2" ID x 6-1/4" H	--	30-102	8332	100-069	\$7.90

**Club Car**

	Dimension	Use With	Oregon	Rotary	Stens	Price
 <p><b>B1SB8331</b> <b>1015426</b> Fits Culb Car with OHV engines.</p>	7-5/8" L x 6" W x 1-11/64" H	--	--	8331	100-659	\$9.40
	 <p><b>B1AF102</b> <b>1013379</b> Replaces Winconsin L0188</p>					
						\$7.90

Replacement Air Filters



**Club Car**

	Dimension	Use With	Oregon	Rotary	Stens	Price
	<b>B1AF244</b> <b>102558201</b> Primary air filter.					
	3-1/2" OD x 1-27/32" ID x 7-1/4" H	Inner Filter-B1AF243	--	9550, 11842	100-533	\$13.10
	<b>B1AF243</b> Inner filter. Fits Engineaire and Kohler CH22-66557, TH16-52527. Replaces Kohler 25 083 03S.					
	--	Filter-B1AF244	--	--	100-541	\$9.20

**Cub Cadet**

	Dimension	Use With	Oregon	Rotary	Stens	Price
	<b>B1SB1385</b> <b>548436R1</b> Replaces Kohler 231847, 25-883-01; Tecumseh 31925.					
	4-3/8" OD x 3" ID x 2-1/4" H	Prefilter-B1SB2780	30-082	1385	100-032	\$4.60
	<b>B1SB2780</b> <b>234869</b> Prefilter					
	--	Filter-B1SB1385	30-125	2780	102-350	\$2.30
	<b>B1SB2774</b> <b>117210C1, 759-3547</b> Fits models KT17, KT19, M18 thru 20, K181, K241-341, CH11-14. For 10, 12, 14, 16. HP quiet series engines, and 17, 18, 19 and 20 HP twin cylinder engines. Replaces Kohler 47 083 01.					
	7" OD x 5-1/2" ID x 1-3/4" H	Prefilter-B1SB5863	30-098	2774	100-107	\$5.20
	<b>B1SB5863</b> Prefilter. Replaces Kohler 52 083 01.					
	--	Filter-B1SB2774	30-947	5863	102-335	\$2.20
	<b>B1SB1384</b> <b>385163R2</b> Replaces Kohler 230840; Tecumseh 30804.					
	4-3/8" OD x 3-1/2" ID x 1-1/2" H	Prefilter-B1SB5934	30-081	1384	100-024	\$3.70
	<b>B1SB5934</b> Prefilter					
	--	Filter-B1SB1384	--	5934	102-343	\$2.00
	<b>B1SB1386</b> <b>385168R2</b> Fits Tecumseh models OH120 thru 175, HH100-115, HH80-120 and VH100-149. For 8 thru 16 HP horizontal engines. Fits Kohler models K241, K301, K321. For 10, 12, 14 HP engines. Replaces Tecumseh 32008; Kohler 235116.					
	6" OD x 4-5/8" ID x 1-7/8" H	Prefilter-B1SB1377	30-080	1386	100-040	\$4.40
	<b>B1SB1377</b> Prefilter. Replaces Kohler 237421; Tecumseh 32906.					
	--	Filter-B1SB1386	--	--	--	\$2.00

**Cub Cadet**

	Dimension	Use With	Oregon	Rotary	Stens	Price
	<b>B1SB1388 - 61606C1, 759-3359</b> Fits Kohler models K341, K321, K482, K532, KT17, KT19, MV16 thru 20, M10 thru M20, CV18 thru CV22. Fits Onan models BF, BFA, BG, BGA, B43, B48. For 16 and 18 HP engines. Replaces Kohler 45 083 02; Onan 140-1216.					
	6" OD x 4-5/8" ID x 3" H	Prefilter-B1SB2844	30-093	1388	100-065	\$5.90
	<b>B1SB2844</b> Prefilter. Replace Kohler 45 083 01; Onan 140-1218					
	--	Filter-B1SB1388	30-946	2844	100-768	\$2.70
	<b>B1SB1390</b> <b>488619R1, TC-30727</b> Fits models LAV, VH40 thru 70, HH60 thru 70, HM80, HS40 thru 50. For 3 thru 8 HP and most vertical and horizontal shaft engines. Metal top. Replaces Tecumseh 30727					
	3-3/4" OD x 2-3/8" ID x 2" H	--	30-070	1390	100-008	\$3.50



**Cushman**

	Dimension	Use With	Oregon	Rotary	Stens	Price
	<b>B1AF109</b> <b>832537</b>					
	3-1/4" OD x 1-11/16" ID x 7-1/2" L	--	30-025	8279	100-465	\$21.80



**Dixie Chopper**

	Dimension	Use With	Oregon	Rotary	Stens	Price
	<b>B1AF110</b> <b>90122</b>					
	4-1/8" OD x 10-3/8" L	--	30-026	8328	100-519	\$25.70

**Dolmar**

	Dimension	Use With	Oregon	Rotary	Stens	Price
	<b>B1AF151</b> <b>391-173-010, 394-173-010, 957-173-720</b> Fits models DPC6300, 6200, 6201, 7300C					
	4-1/8" L x 3" W x 2-3/8" H	Prefilter-B1AF152	--	9957	605-840	\$11.80
	<b>B1AF152</b> <b>391-173-030, 394-173-030</b> Prefilter					
	5-3/8" L x 3-1/4" W x 3/4" H	Filter-B1AF151	--	9958	605-361	\$4.90

**Donaldson**

	Dimension	Use With	Oregon	Rotary	Stens	Price
	<b>B1AF110</b> <b>P13-6840, P181050</b>					
	4-1/8" OD x 10-3/8" L	--	30-026	8328	100-519	\$25.90
	<b>B1AF244</b> <b>P822686</b> Primary air filter.					
	3-1/2" OD X 1-27/32" ID X 7-1/4" H	Inner Filter-B1AF243	--	9550	100-533	\$13.10

Replacement Air Filters

**Donaldson**

	Dimension	Use With	Oregon	Rotary	Stens	Price
	<b>B1AF243</b> <b>P535396</b> Inner filter. Fits Engineaire and Kohler CH22-66557, TH16-52527. Replaces Kohler 25 083 03S					
	--	Filter-B1AF244	--	--	100-541	\$9.20



**Echo**

	Dimension	Use With	Oregon	Rotary	Stens	Price
	<b>B1AF117</b> <b>13030508360, 13030508361</b> Fits Echo backpack blower models PB4600 and PB6000					
	10-1/2" L x 3" W x 3/4" H	--	55-201	8735	100-293	\$4.70
	<b>B1EC24</b> <b>13031700760</b> For backpack blowers. Use with heavy duty filter kit. Fits Echo PB400E and Toro 40cc blowers. Also fits John Deere models 4 and 4E.					
	3-1/4" OD x 1-3/4" ID x 7" H	--	30-143	8585	100-576	\$12.10
	<b>B1EC60</b> <b>13031000760</b> Fits Echo back pack blowers PB-400.					
	2-15/16" OD x 3/8" H	--	30-516	7160	--	\$1.00
	<b>B1EC90</b> <b>13031054130</b> Fits models: GT2000, GT1100, GT2400 trimmers; ES2100, ES2400 shredder vacs; HC1500, HC2000, HC2400, HC2410 hedge trimmers. Power Pruner. Mantis Tillers.					
	--	--	--	--	102-565	\$5.40
	<b>B1EC91</b> <b>13031051830</b> Fits Echo PAS2400, PB24LN, PAS2601, PE260, SRM2400, SRM2601, SRM260S, SRM3100, ES231, HCA2400, HCA261, ST2400, HCA260, PAS260, PE2601, and PB260i.					
	3-7/64" L x 3-1/16"W x 5/16" H	--	30-121	12377	102-561	\$6.20
	<b>B1SB10269</b> <b>A226000031, A226000032</b> Fits Echo blowers PB403, PB13, PB603, PB611, and PB650.					
	--	--	30-349-1	10269	102-569	\$5.70
	<b>B1SB72000</b> <b>13031051730</b> Fits Echo SRM2500 trimmer.					
	--	--	--	9067	--	\$2.90
	<b>B1SB9066</b> <b>13031004560</b> Fits Echo 2400 hedge clipper.					
	--	--	30-003	9066	100-416	\$2.80
	<b>B1AF90</b> <b>13031004922</b> 2-7/16" Diameter. Fits most trimmers such as Echo, Poulan, and Toro using Kioritz engines.					
	2-7/16" OD	--	55-506	6966	100-404	\$3.20

**Emglo**

	Dimension	Use With	Oregon	Rotary	Stens	Price
	<b>B1SB2773</b> <b>L54E Fits models 146400, 170400, 171400, 190400. For 6 thru 8 HP horizontal engines. Replaces Briggs &amp; Stratton 390492.</b>					
	3-3/4" OD x 1-3/8" ID x 2-7/8" H	--	30-097	2773	100-099	\$4.50







**Enginaire**

	Dimension	Use With	Oregon	Rotary	Stens	Price
	<b>B1AF244</b> <b>68300</b>					
	3-1/2" OD x 1-27/32" ID x 7-1/4" H	Inner Filter-B1AF243	--	9550	100-533	\$13.10
	<b>B1AF243</b> <b>68340 Inner filter.</b>					
	--	Filter-B1AF244	--	--	100-541	\$9.20

**Excel**

	Dimension	Use With	Oregon	Rotary	Stens	Price
	<b>B1AF110</b> <b>3029</b>					
	4-1/8" OD x 10-3/8" L	--	30-026	8328	100-519	\$25.90

**Exmark**

	Dimension	Use With	Oregon	Rotary	Stens	Price
	<b>B1AF244</b> <b>93-2195, 932195 Fits Lazer Z with 27 HP liquid cooled Kawasaki engine.</b>					
	3-1/2" OD x 1-27/32" ID x 7-1/4" H	Inner Filter-B1AF243	--	9550, 11842	100-533	\$13.10
	<b>B1AF243</b> <b>98-2982 Inner filter</b>					
	--	Filter-B1AF244	--	--	100-541	\$9.20
	<b>B1AF204</b> <b>103-1327 Fits Lazer Z, Z Advantage, Z HP, Z XP and Z XS with 31, 35 HP Briggs; 28, 29 HP Kawasaki; 25, 27, 28 HP Kohler; 25 HP Kubota Diesel and 27 HP Diahatsu Diesel engines.</b>					
	4" OD x 2-13/32" ID x 10-1/2" H	Inner Filter-B1AF201	30-055	9583	102-305	\$21.10
	<b>B1AF204B</b> <b>103-1327 Bulk package of B1AF204 (12).</b>					
	4" OD x 2-13/32" ID x 10-1/2" H	--	30-055	9583	102-305	\$198.00
	<b>B1AF201</b> <b>103-1326 Inner Filter</b>					
	--	Filter-B1AF204	30-056	9728	100-780	\$21.70
	<b>B1AF201B</b> <b>103-1326 Bulk package of B1AF201 (12).</b>					
	--	--	30-056	9728	055-165	\$206.40

Replacement Air Filters

Exmark







	Dimension	Use With	Oregon	Rotary	Stens	Price
 <p><b>B1AF8329</b> Fits Z Advantage with 25 HP Kohler engine.</p>	7" OD x 5-1/2" ID x 3" H	Prefilter-B1AF8966	30-089	8329	100-758	\$7.40
 <p><b>B1AF8966</b> Prefilter</p>	--	Filter-B1AF8329	30-945	8966	100-754	\$2.00
 <p><b>B1SB2777</b> Fits Z CT with 18, 21 and 23 HP Briggs &amp; Stratton engines.</p>	7" OD x 5-5/8" ID x 2-1/8" H	Prefilter-B1SB2797	30-101	2777	100-131	\$5.40
 <p><b>B1SB2797</b> Prefilter.</p>	--	Filter-B1SB2777	30-929	2797	100-743	\$3.50
 <p><b>B1AF214</b> Fits Metro, Turf Tracer HP, and Viking with 15 HP Kawasaki engine.</p>	7-3/8" L x 4-3/8" W x 1" H	Prefilter-B1AF218	--	10313	102-354	\$12.30
 <p><b>B1AF218</b> Prefilter</p>	--	Filter-B1AF214	--	10305	--	\$1.00
 <p><b>B1AF8235</b> Fits Metro with 15 HP Kohler engine.</p>	4-9/16" OD x 3-3/4" ID x 3-5/16" H	Prefilter-B1SB8712	30-088	8235	100-957	\$7.40
 <p><b>B1SB8712</b> Prefilter</p>	--	Filter-B1AF8235	30-943	8712	100-953	\$1.70
 <p><b>B1AF171</b> Fits Turf Tracer HP with 19 HP Kawasaki engine.</p>	8-5/16" L x 1-3/16" H x 3-13/16" W; 6-7/16" W with tab; filter and lip 6-1/2" W	Prefilter-B1AF173	30-322	9506	100-160	\$15.80
 <p><b>B1AF171B</b> Bulk package of B1AF171 (24). Includes B1AF173 prefilter.</p>	8-5/16" L x 1-3/16" H x 3-13/16" W; 6-7/16" W with tab; filter and lip 6-1/2" W	--	30-322	9506	100-160	\$256.80





**Exmark**

	Dimension	Use With	Oregon	Rotary	Stens	Price
	<b>B1AF173</b> Prefilter					
	--	Filter-B1AF171	30-940	9611	100-168	\$1.30

**EZ-GO**





	Dimension	Use With	Oregon	Rotary	Stens	Price
	<b>B1AF204</b> <b>B72987G01</b> Fits heavy duty engines with remote air canister.					
	4" OD x 2-13/32" ID x 10-1/2" H	Inner Filter-B1AF201	30-055	9583	102-305	\$21.10
	<b>B1AF204B</b> <b>72987G01</b> Bulk package of B1AF204 (12).					
	4" OD x 2-13/32" ID x 10-1/2" H	--	30-055	9583	102-305	\$198.00
	<b>B1AF201</b> Inner filter.					
	--	Filter-B1AF204	30-056	9728	100-780	\$20.90
	<b>B1AF201B</b> Bulk package of B1AF201 (12).					
	--	--	30-056	9728	055-165	\$206.40
	<b>B1AF244</b> <b>28463G01</b> Primary air filter.					
	3-1/2" OD x 1-27/32" ID x 7-1/4" H	Inner Filter-B1AF243	--	9550, 11842	100-533	\$13.10
	<b>B1AF243</b> Inner filter. Fits Engineaire and Kohler CH22-66557, TH16-52527. Replaces Kohler 25 083 03S.					
	--	Filter-B1AF244	--	--	100-541	\$9.20
	<b>B1AF102</b> <b>14416GL</b> Replaces Wisconsin L0188.					
	4-1/4" OD x 2" ID x 6-1/4" H	--	30-102	8332	100-069	\$7.90

**Ferris**





	Dimension	Use With	Oregon	Rotary	Stens	Price
	<b>B1AF204</b> <b>5022892X1, 5023141, 841237</b> Fits heavy duty engines with remote air canister.					
	4" OD x 2-13/32" ID x 10-1/2" H	Inner Filter-B1AF201	30-055	9583	102-305	\$21.10
	<b>B1AF204B</b> <b>5022892X1, 5023141, 841237</b> Bulk package of B1AF204 (12).					
	4" OD x 2-13/32" ID x 10-1/2" H	--	30-055	9583	102-305	\$198.00

Replacement Air Filters



**Ferris**

	Dimension	Use With	Oregon	Rotary	Stens	Price
	<b>B1AF201</b> 5022892X2, 5023140, 841238 Inner filter.					
	--	Filter-B1AF204	30-056	9728	100-780	\$21.70
	<b>B1AF201B</b> 5022892X2, 5023140, 841238 Bulk package of B1AF201 (12).					
	--	--	30-056	9728	055-165	\$206.40
	<b>B1AF244</b> 5100192 Primary air filter.					
	3-1/2" OD x 1-27/32" ID x 7-1/4" H	Inner Filter-B1AF243	--	9550, 11842	100-533	\$13.10
	<b>B1AF243</b> Inner filter. Fits Engineaire and Kohler CH22-66557, Th16-52527. Replaces Kohler 28 083 03S.					
	--	Filter-B1AF244	--	--	100-541	\$9.20

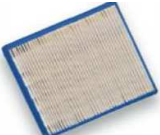

**Fleet Guard**

	Dimension	Use With	Oregon	Rotary	Stens	Price
	<b>B1AF244</b> AF25538, AF25550 Primary air filter.					
	3-1/2" OD x 1-27/32" ID x 7-1/4" H	Inner Filter-B1AF243	--	9550, 11842	100-533	\$13.10
	<b>B1AF243</b> AF25967 Inner filter.					
	--	Filter-B1AF244	--	--	1100-541	\$9.20
	<b>B1AF270</b> AF26168 Fits certain Kawasaki engines.					
	4.126" OD x 3.189" ID x 10.724" L	Inner Filter-B1AF271	30-157	--	100-656	\$22.70
	<b>B1AF271</b> AF26166, AF26351 Prefilter for our B1AF270.					
	3.189" OD	Filter-B1AF270	30-158	--	100-660	\$18.00







**Generac**

	Dimension	Use With	Oregon	Rotary	Stens	Price
	<b>B1AF240</b> 73111GS Air Filter for Generac 7500EXL, 5500CX, 5500CXE.					
	5-5/8" L x 4-1/2" W x 1-1/4" H	--	--	11042	100-572	\$4.60
	<b>B1AF204</b> 0E3557 Fits heavy duty engines with remote air canister.					
	4" OD x 2-13/32" ID x 10-1/2" H	Inner Filter-B1AF201	30-055	9583	102-305	\$21.10

**Generac**

	Dimension	Use With	Oregon	Rotary	Stens	Price
 <p><b>B1AF204</b> <b>0E3557</b> Bulk package of B1AF204 (12).</p>	4" OD x 2-13/32" ID x 10-1/2" H	--	30-055	9583	102-305	\$198.00
 <p><b>B1AF201</b> <b>0E3656</b> Inner filter.</p>	--	Filter-B1AF204	30-056	9728	100-780	\$21.70
 <p><b>B1AF201B</b> <b>0E3656</b> Bulk package of B1AF201 (12).</p>	--	--	30-056	9728	055-165	\$206.40

**Grasshopper**

	Dimension	Use With	Oregon	Rotary	Stens	Price
 <p><b>B1AF204</b> <b>100936</b> Fits heavy duty engines with remote air canister.</p>	4" OD x 2-13/32" ID x 10-1/2" H	Inner Filter-B1AF201	30-055	9583	102-305	\$21.10
 <p><b>B1AF204B</b> <b>100936</b> Bulk package of B1AF204 (12).</p>	4" OD x 2-13/32" ID x 10-1/2" H	--	30-055	9583	102-305	\$198.00
 <p><b>B1AF201</b> <b>100937</b> Inner filter.</p>	--	Filter-B1AF204	30-056	9728	100-780	\$21.70
 <p><b>B1AF201B</b> <b>100937</b> Bulk package of B1AF201 (12).</p>	--	--	30-056	9728	055-165	\$206.40
 <p><b>B1SB2790</b> <b>100941</b> Fits model NHC, T260, NHA, NHB, B43, P216, P218, P220, P224. For 16 thru 20 HP engines. Replaces Onan 140-1228, 140-2522, 140-2628.</p>	8" OD x 6-5/8" ID x 2-1/8" H	Prefilter-B1SB7050	30-430	2790	100-149	\$5.70
 <p><b>B1SB7050</b> Prefilter. Replaces Onan 140-1496.</p>	--	Filter-B1SB2790	30-011	7050	100-875	\$2.80

**Gravely**

	Dimension	Use With	Oregon	Rotary	Stens	Price
 <p><b>B1AF204</b> <b>21536900, 21537000, 21538600</b> Fits heavy duty engines with remote air canister.</p>	4" OD x 2-13/32" ID x 10-1/2" H	Inner Filter-B1AF201	30-055	9583	102-305	\$21.10

Replacement Air Filters

Gravely



	Dimension	Use With	Oregon	Rotary	Stens	Price
 <p><b>B1AF204B</b>  <b>21536900, 21537000, 21538600</b> Bulk package of B1AF204 (12).</p>	4" OD x 2-13/32" ID x 10-1/2" H	--	30-055	9583	102-305	\$198.00
 <p><b>B1AF201</b>  <b>21536900, 21538700</b> Inner filter.</p>	--	Filter-B1AF204	30-056	9728	100-780	\$21.70
 <p><b>B1AF201B</b>  <b>21536900, 21538700</b> Bulk package of B1AF201 (12.)</p>	--	--	30-056	9728	055-165	\$206.40
 <p><b>B1AF244</b>  <b>21512500</b> Primary air filter.</p>	3-1/2" OD x 1-27/32" ID x 7-1/4" H	Inner Filter-B1AF243	--	9550, 11842	100-533	\$13.10
 <p><b>B1AF243</b>                      Inner filter. Fits Engineaire and Kohler CH22-66557, TH16-52527. Replaces Kohler 25 083 03S.</p>	--	Filter-B1AF244	--	--	100-541	\$9.20
 <p><b>B1AF205</b>  <b>21496000, 21495900, 21495800</b> Fits Kawasaki FD590V-A504, FD590V-A505 18 HP liquid cooled engine. Replaces Kawasaki 11013-2114, 11013-2115, 11029-2001.</p>	8-3/4" L x 3-5/8" W x 2-3/4" H	--	30-018	9841	100-238	\$17.60
 <p><b>B1SB1387</b>  <b>21449300</b> Fits models K532, K582, K482 and K301, K321. For 12, 14, 18, 20 and 23 HP engines. Replaces Kohler 277138.</p>	6" OD x 4-3/4" ID x 4" H	Prefilter-B1SB6516	30-092	1387	100-057	\$5.60
 <p><b>B1SB6516</b>                      Prefilter.</p>	--	Filter-B1SB1387	30-129	6516	--	\$1.80
 <p><b>B1SB2774</b>  <b>32494</b> Fits models KT17, KT19, M18 thru 20, K181, K241-341, CH11-14. For 10, 12, 14, 16 HP quiet series engines and 17, 18, 19 and 20 HP twin cylinder engines. Replaces Kohler 47 083 01.</p>	7" OD x 5-1/2" ID x 1-3/4" H	Prefilter-B1SB5863	30-098	2774	100-107	\$5.20
 <p><b>B1SB5863</b>                      Prefilter. Replaces Kohler 52 083 01.</p>	--	Filter-B1SB2774	30-947	5863	102-335	\$2.20
 <p><b>B1SB1388</b>  <b>34766, 43644</b> Fits Kohler models K341, K321, K482, K532, KT17, KT19, MV16 thru 20, M10 thru M20, CV18 thru CV22. Fits Onan models BF, BFA, BG, BGA, B43, B48. For 16 and 18 HP engines. Replaces Kohler 45 083 02; Onan 140-1216</p>	6" OD x 4-5/8" ID x 3" H	Prefilter-B1SB2844	30-093	1388	100-065	\$5.90

## Gravely



	Dimension	Use With	Oregon	Rotary	Stens	Price
	<b>B1SB2844</b> <b>34768, 46346</b> Prefilter. Replaces Kohler 45 083 01; Onan 140-1218					
--	Filter-B1SB1388	30-946	2844	100-768	\$2.70	
	<b>B1AF280</b> <b>42926</b> Fits models FB460. For 12.5 HP engines. Replaces Kawasaki 11013-2021					
7" L x 2-1/4" W x 2-3/4" H	Prefilter-B1SB5861	30-303	6567	100-347	\$9.90	
	<b>B1SB5861</b> <b>42925</b> Prefilter. Replaces Kawasaki 11013-2020.					
--	Filter-B1AF280	30-935	5861	100-354	\$1.90	
	<b>B1SB6706</b> <b>21391300</b> Fits FC420V. For 14 HP vertical engine. Prefilter included. Replaces Kawasaki 11013-2141.					
6-1/8" L x 2-7/8" W wide end, 2-1/4" W narrow end x 3" H	Prefilter-B1AF96	30-311	6706	100-052	\$9.90	
	<b>B1AF8235</b> Fits CV11, CV12.5, CV14, and CV15T commercial walk-behinds.					
4-9/16" OD x 3-3/4" ID x 3-5/16" H	Prefilter-B1SB8712	30-088	8235	100-957	\$7.40	
	<b>B1SB8712</b> <b>21507700</b> Prefilter. Replaces Kohler 12 083 12. Fits CV11 and CV14 engines.					
--	Filter-B1AF8235	30-943	8712	100-953	\$1.70	
	<b>B1SB1386</b> <b>10900, 43954</b> Fits Tecumseh models OH120 thru 175, HH100-115, HH80-120 and VH100-149. For 8 thru 16 HP horizontal engines. Fits Kohler models K241, K301, K321. For 10, 12, 14 HP engines. Replaces Tecumseh 32008; Kohler 235116.					
6" OD x 4-5/8" ID x 1-7/8" H	Prefilter-B1SB1377	30-080	1386	100-040	\$4.40	
	<b>B1SB1377</b> <b>19332</b> Prefilter. Replaces Kohler 237421; Tecumseh 32906.					
--	Filter-B1SB1386	30-941	1377	100-750	\$2.00	
	<b>B1SB1384</b> <b>20299</b> Replaces Kohler 230840; Tecumseh 30804.					
4-3/8" OD x 3-1/2" ID x 1-1/2" H	Prefilter-B1SB5934	30-081	1384	100-024	\$3.70	
	<b>B1SB5934</b> Prefilter					
--	Filter-B1SB1384	--	5934	102-343	\$2.00	
	<b>B1SB1385</b> <b>15373</b> Replaces Kohler 231847, 25-883-01; Tecumseh 31925.					
4-3/8" OD x 3" ID x 2-1/4" H	Prefilter-B1SB2780	30-082	1385	100-032	\$4.60	

Replacement Air Filters





**Gravely**

	Dimension	Use With	Oregon	Rotary	Stens	Price
	<b>B1SB2780</b> Prefilter					
	--	Filter-B1SB1385	30-125	2780	102-350	\$2.30
	<b>B1AF313</b> <b>43022</b> For 5.2 HP engines. Fits model FA210. Replaces Kawsaki 49064-2059, 3255AA-1312A.					
	2-15/16" OD x 1-7/8" H / base 4-7/8" L x 4-1/4" W	--	30-313	7714	--	\$13.50
	<b>B1AF102</b> <b>21333</b> For 17 and 20 HP engines. Replaces Wisonsin L0188.					
	4-1/4" OD x 2" ID x 6-1/4" H	--	30-102	8332	100-069	\$7.90

**Grazer**

	Dimension	Use With	Oregon	Rotary	Stens	Price
	<b>B1SB2777</b> <b>900-5005</b> Fits models 290000, 290400, 290700, 294000, 294400, 294700, 303400, 303700, 303900, 392642, 394018, 400400 thru 422400, 350700, 350400, 351400. For L-Head Twin horizontal and all vertical V-Twin OHV Vanguard Engines. Replaces Briggs & Stratton 392642, 394018.					
	7" OD x 5-5/8" ID x 2-1/8" H	Prefilter-B1SB2797	30-101	2777	100-131	\$5.40
	<b>B1SB2797</b> Prefilter. Replaces Briggs & Stratton 271271, 272490.					
	--	Filter-B1SB2777	30-929	2797	100-743	\$3.50

**Green Machine**

	Dimension	Use With	Oregon	Rotary	Stens	Price
	<b>B1AF99</b> <b>170078</b> Minimum order of 5.					
	2-3/4" L x 11/16" W x 3/8" H	--	--	7208	102-210	\$0.40
	<b>B1WE229</b> <b>309889</b> Air Cleaner Assembly.					
	--	Filter-B1SB5864	--	7926	--	\$7.90
	<b>B1SB5864</b> <b>309891</b> Fits Green Machine model 3000S. Packaged in lots of five.					
	2-3/8" OD x 1/2" H	Air Cleaner Assembly B1WE229	55-507	5864	100-826	\$1.20
	<b>B1WE232</b> <b>309889</b> Air filter assembly. Fits Green Machine 2500 and 2800. Replaces Walbro 21-413					
	--	--	--	8080	--	\$9.40



## Hoffco

	Dimension	Use With	Oregon	Rotary	Stens	Price
	<b>B1AF90</b> <b>208645</b> 2-7/16" Diameter. Fits most trimmers such as Echo, Poulan, and Toro using Kioritz engines.					
	2-7/16" OD	--	55-506	6966	100-404	\$3.20

## Homelite

	Dimension	Use With	Oregon	Rotary	Stens	Price
	<b>B1SB8239</b> <b>D-06615</b> Fits models Homelite 2625CD, Z625CDV, 2825SD, 2725CB, 2830SB, D630CD, D730CDV, D830SD, D830CB, D830SB.					
	--	--	30-063	8239	100-329	\$0.90
	<b>B1AF75</b> <b>D-98760-B</b> Fits Homelite 16cc, 25cc and 30cc trimmers, blowers, hedge trimmers, and mini tillers. Also fits models ST145, 155, 175, 185, 285, 385, 485, and Wizard models HB100, HB180 and HB180V. Order in multiples of five.					
	--	--	55-508	8238	100-859	\$1.20
	<b>B1AF15</b> <b>46073</b> Fits DM-50 cut off saws.					
	4-1/4" OD x 2" ID x 2-1/2" H	--	--	6511	--	\$4.60
	<b>B1AF50</b> <b>54620-B</b> Fits XL-98A, C and D Cut-off saws.					
	5" OD x 4" ID x 2-1/8" H	Prefilter-B1SB2780	--	8334	--	\$6.10
	<b>B1SB2780</b> Prefilter					
	--	Filter-B1AF50	30-125	2780	102-350	\$2.30
	<b>B1AF13</b> <b>65178-A</b> Fits models EZ and EZA					
	3-7/8" x 2-7/8"	--	55-207	3111	605-121	\$6.70
	<b>B1AF08</b> <b>69141, D92702B</b> Fits Homelite XL-2. Minimum order quantity of five.					
	2" L x 1-3/8" x 1-5/8" W x 1/2" H	--	55-228	1547	605-139	\$0.70
	<b>B1AF12</b> <b>63589-B</b> Fits models SXL, XL-12, XL-15, XL-400 and XL-500.					
	4" L x 3-3/8" W x 5/8" H	--	55-211	1550	605-105	\$7.00
	<b>B1SB8818</b> <b>2308, UP056131</b> Fits model MP38, 12" & 14" and MP88, 14".					
	3" ID x 7" OD x 2-5/8" H	--	--	8818	--	\$9.00

Replacement Air Filters

**Honda**

	Dimension	Use With	Oregon	Rotary	Stens	Price
	<b>B1SB7044</b> <b>17210-ZE0-505, 17210-ZE8-820, 17210-ZE8-822</b> Honda code 2893873. For 3.5 and 4 HP engines. Fits 6X110 old 3.5 HP, 6X126 new 4 HP engines. Also fits tiller models 400, 401K1 horizontal engine. Includes prefilter.					
	4" L x 3" W x 2" H	Prefilter-B1SB7045	30-318	7044	100-958	\$9.60
	<b>B1SB7045</b> <b>17218-ZE0-821</b> Prefilter. Honda code 2535011.					
	--	Filter-B1SB7044	--	7045	102-053	\$1.90
	<b>B1SB6684</b> <b>17210-ZE7-003, 17210-ZE7-013, 17210-ZE7-505</b> Honda code 2741627/2289734/5310289. Fits engine models GVX120, GVS140, and GVX160. For commercial mower models HR216, HRA216. For 4 and 5 HP vertical engine. Includes prefilter.					
	7-1/2" L x 2-1/2" W x 1-7/8" H	Prefilter-B1SB7726	30-401	6684	102-582	\$11.00
	<b>B1SB7726</b> <b>17218-888-003</b> Prefilter. Honda code 1067149.					
	--	Filter-B1SB6684	30-939	7726	--	\$2.10
	<b>B1SB7713 - 17211-888-013, 17210-ZE6-003, 17210-ZE6-505</b> Honda code 1007483, 1495902. Fits engine models GXV120, GV150, GV200. For mower models HR194, HR195, HR214, HRA214, HRA214. For 3.5, 4 and 5 HP vertical engines. Open, no top cap. Includes prefilter.					
	7-1/2" L x 2-1/2" W x 2" H	Prefilter-B1SB7726	30-400	7713	100-719	\$12.00
	<b>B1SB7726</b> <b>17218-888-003</b> Prefilter. Honda code 1067149					
	--	Filter-B1SB7713	30-939	7726	--	\$2.10
	<b>B1SB7042</b> <b>17211-ZA0-702, 17210-ZA0-506</b> Honda code 2893923. Fits HT3813 and 4213 tractors. Also fits GX360K1. Vertical engines.					
	6-1/2" L x 4-1/8" W x 1-5/8" H	Prefilter-B1SB7043	30-317	7042	100-428	\$18.90
	<b>B1SB7043</b> <b>17218-ZA0-701</b> Prefilter. Honda code 3712478					
	--	Filter-B1SB7042	--	7043	100-432	\$1.90
	<b>B1SB7712</b> <b>17210-ZE3-010, 17210-ZE3-505</b> Honda code 2893907. Fits models GX340, GX390. For 8 thru 13 HP engines. Includes prefilter.					
	4-3/8" L x 3-3/4" W x 3-5/8" H	Prefilter-B1SB7725	30-417	7712	100-012	\$16.10
	<b>B1SB7725</b> <b>17218-ZE3-000, 17218-ZE3-505</b> Prefilter. Honda code 2577377.					
	--	Filter-B1SB7712	--	7725	100-028	\$3.30

**Honda**





	Dimension	Use With	Oregon	Rotary	Stens	Price
	<b>B1SB6686</b> 172A-188-3902 Honda code 2893915. Fits model G200 engines, Includes prefilter.					
	3-1/8" top OD x 4-3/8" bottom OD x 2-3/8" H	--	--	6686	--	\$13.50
	<b>B1AF84 - 17210-ZE1-820, 17210-ZE1-821, 17210-ZE1-822, 17210-ZE1-505, 17210-ZE1-517</b> Honda code 2893881, 5247408, 1445782. Fits models GX110, GX120, GX140, GX160. For 3.5, 5, and 5.5 HP engines. Includes prefilter.					
	4" L x 2-7/8" W x 2-3/4" H	Prefilter-B1SB6691	30-404	6690	100-784	\$9.30
	<b>B1AF84B - 17210-ZE1-820, 17210-ZE1-821, 17210-ZE1-822, 17210-ZE1-505</b> Bulk package of B1AF84 (30). Include prefilter.					
	4" L x 2-7/8" W x 2-3/4" H	--	30-404	6690	100-784	\$222.00
	<b>B1SB6691</b> 17218-ZE1-821 Prefilter. Honda code 2535029.					
	--	Filter-B1AF84	30-506	6691	100-966	\$2.10
	<b>B1SB2808 - 17210-ZE8-003, 17210-ZE8-013, 17210-ZF5-010, 17218-ZF5-505</b> Honda code 2090207, 2910727, 5248299. Fits models GXV270, GXV340, GXV390. For 8.5 thru 13 HP vertical OHV engines. Includes prefilter.					
	5" L x 2-5/8" W x 3-1/8" H	Prefilter-B1SB2809	30-405	2808	102-244	\$17.40
	<b>B1SB2809</b> Prefilter					
	--	Filter-B1SB2808	30-507	2809	--	\$1.70
	<b>B1AF89 - 17211-890-003, 17211-890-013, 17211-890-023, 17210-890-505</b> Honda code 1021518, 0755439, 2893931. Fits models G300, G400, GX340. For 7, 10 and 11 HP engines. For model 3810 tractors, and 5500, 6500 generators. Includes prefilter.					
	5-3/8" bottom OD x 3-7/8" top OD x 2-5/8" H	--	30-403	6688	100-792	\$11.50
	<b>B1SB8906 - 17211-ZE7-W03, 17211-ZE7-W01, 17211-ZE7-W02</b> Honda code 5357389. Fits GVX160, HPC216K1HA, HRC216K15XA 5.5 HP vertical shaft engine. Includes prefilter.					
	6-3/4" L x 2-1/4" W x 2" H	Prefilter-B1SB8907	30-015	8906	102-263	\$14.40
	<b>B1SB8907</b> 17211-ZG7-W03 Prefilter					
	--	Filter-B1SB8906	--	8907	--	\$3.50
	<b>B1AF71 - 17210-ZE2-505, 17210-ZE2-821, 17210-ZE2-822, 17210-ZE2-515</b> Fits Honda code 2893899, 5266721. Fits models GX240, GX270 and GX240K1. For 8 and 9 HP horizontal engines. Includes prefilter.					
	4" L x 3-9/16" W x 3-1/6" H	Prefilter-B1SB6693	30-406	6692	100-818	\$8.90
	<b>B1SB6693</b> 17218-ZE2-821 Prefilter. Honda code 2538429.					
	--	Filter-B1AF71	30-934	6693	--	\$1.70

Replacement Air Filters

**Honda**

	Dimension	Use With	Oregon	Rotary	Stens	Price
 <p><b>B115146</b>  <b>17210-759-013</b> Fits model GX610, 620 with remote type air cleaner assembly.</p>	3-5/8" OD x 1-3/4" ID x 8" H	--	--	10680	--	\$25.20
 <p><b>B1AF129</b>  <b>17010-ZJ1-000, 17211-ZJ1-000</b> Fits old style GX620</p>	5-1/4" L x 4-1/2" W x 3/4" H	--	--	10679	102-719	\$21.80
 <p><b>B1AF208</b>  <b>17211-ZL8-000, 17211-ZL8-023, 5580402</b> Honda code 5580402. Fits models HRS216, HRR216, HRT216, GC135, GCV135, GC160, and GCV160 engines.</p>	5-1/2" L x 4-1/2" W x 3/4" H	Base and Cover - B115141	30-347	9953	102-713	\$3.90
 <p><b>B1AF208B</b>  <b>17211-ZL8-000, 5580402</b> Bulk package of B1AF208 (60).</p>	5-1/2" L x 4-1/2" W x 3/4" H	--	--	9953	102-713	\$205.00
 <p><b>B115141</b>  <b>17231-ZM0-00, 17220-ZM0-000</b> Air cleaner base and cover. Fits models GCV 134/160.</p>	--	Filter-B1AF208	--	10477	--	\$8.80
 <p><b>B115139</b>  <b>7211-Z0Z-013</b> Fits models GVC530 &amp; GXV530, 16 HP V-twin vertical shaft units.</p>	8-5/8" L x 4-3/4" W x 7/8" H	--	--	10879	102-731	\$15.60
 <p><b>B115140</b>  <b>17210-ZJ1-841, 17210-ZJ1-842, 17218-ZJ1-840</b> Fits models 610K1, 620K1, 670, GXV610K1, GXV620K1.</p>	9" L x 6-1/2" W x 1-1/4" H	--	30-436	10678	102-164	\$27.50
 <p><b>B1AF601</b>  <b>17210-ZJ1-841, 17210-ZJ1-842, 17218-ZJ1-840</b> Fits models 610K1, 620K1, 670, GXV610K1, GXV620K1.</p>	--	Filter-B115140	--	10961	--	\$2.00
 <p><b>B1AF128</b>  <b>17211-ZG9-800, 1728-269-800</b> Honda code 4327383/432739. Fits models GXV140, 5 HP vertical shaft. Also fits Harmony walk-behind mowers.</p>	5-1/4" L x 2-1/4" W x 1" H	Prefilter-B1SB8904	30-027	8903	102-149	\$5.20
 <p><b>B1SB8904</b>  <b>17218-ZG9-800</b> Prefilter. Honda code 4327391/4327383. Fits model GXV140.</p>	--	Filter-B1AF128	--	8904	102-149	\$0.80
 <p><b>B1AF7980</b>  <b>08170-ZG9-M00, 17211-ZG9-M00</b> Fits Honda code 4527479. Fits SX series, Harmony 215, HRM215, HRB215, HR215K1.</p>	5-3/4" L x 3-1/2" W x 1" H	Prefilter-B1AF7979	30-709	7980	100-378	\$8.50

## Honda



	Dimension	Use With	Oregon	Rotary	Stens	Price
	<b>B1AF7979</b> <b>17218-ZG9-M00</b> Prefilter.					
	5-1/2" L x 3-1/4" W x 1/4" H	Filter-B1AF7980	30-932	7979	--	\$0.90
	<b>B1SB6707</b> Old-style rubber grommet used on Honda filter.					
	--	--	--	6707	--	\$0.50
	<b>B1SB6708</b> <b>17232-891-000</b> Metal-rubber grommet.					
	--	--	30-036	6708	--	\$1.00
	<b>B1AF257</b> <b>17211-ZF5-V01, 17218-ZF5-V00</b> Fits GXV340K2, GXV390K1 engines; HRC7113, HRC7013, H2113, H2013 and H1011 mowers.					
	4-7/8" L x 2-9/16" W x 3-7/16" H	--	30-064	11793	102-218	\$10.30

## Husqvarna

	Dimension	Use With	Oregon	Rotary	Stens	Price
	<b>B11621</b> <b>506 14 57-01, 506 14 58-01</b> Air filter kit fits Husqvarna 272K and 268K cut off saws. Includes prefilter					
	4-1/16" L x 4" W x 3-3/16" H	--	--	9955, 9956	605-299, 605-295	\$14.10
	<b>B1AF149</b> <b>506 26 91-01</b> Prefilter. Three layer foam.					
	5/8" L x 4-7/8" W x 3/4" H	Filter-B1AF148	--	--	605-341	\$9.90
	<b>B1AF146</b> <b>506 14 58 01</b> Fits models 268K and 272K cut-off saws.					
	4-1/16" L x 4" W x 3-3/16" H	Prefilter-B1AF147	--	9956	605-299	\$14.10
	<b>B1WE7</b> <b>530 02 43-71</b> Fits all Poulan XR series 1400, 1500, 1600, 1700, 4000, 5000, 6000 and Pro 150.					
	2-5/8" L x 1-1/4" W x 1-1/4" H	--	55-500	4300	100-297	\$1.70
	<b>B1AF148</b> <b>506 26 34-01</b> Fits Husqvarna 371K EPA cut-off saws					
	3-23/32" L x 3-3/4" W x 2-1/16" H	Prefilter-B1AF149	--	10779	605-291	\$14.50
	<b>B1AF58</b> <b>501 80 71-01, 501 80 71-05, 501 80 71-06</b> Fits models 266, 61, 66, 281, 288. Screen type.					
	--	--	--	--	--	\$16.60
	<b>B1AF262</b> <b>506 36 72-102, 544 18 16-01, 544 18 16-02</b> Fits K750 cut-off saws.					
	--	--	--	12887	605-381	\$9.00

Replacement Air Filters

**Husqvarna**





	Dimension	Use With	Oregon	Rotary	Stens	Price
	<b>B1AF325</b> <b>506 23 18-01, 506 23 18-02, 506 23 19-01</b> Fits K950 and K1250 cut off saws.					
	6" L x 4-1/2" W x 2-5/8" H	Prefilter-B1AF163	--	--	605-046	\$17.40
	<b>B1AF163</b> <b>506 23 19-01</b> Prefilter					
	--	Filter-B1AF325	--	--	605-257	\$6.70

**Hustler**







	Dimension	Use With	Oregon	Rotary	Stens	Price
	<b>B1AF110</b> <b>3029</b>					
	4-1/8" OD x 10-3/8" L	--	30-026	8328	100-519	\$25.90
	<b>B115140</b> <b>785600</b> Fits Hustler Z. Mini Z and Super Mini Z with Honda 24 HP engine					
	9" L x 6-1/2" W x 1-1/4" H	--	--	10678	102-164	\$27.50
	<b>B1AF202</b> <b>780171, 601155</b> Fits Kawasaki 23 HP engines.					
	7-1/4" L x 3-1/4" W x 3-1/8" H	Prefilter-B1AF286	30-054	9584	100-622	\$16.50
	<b>B1AF286</b> <b>780155</b> Prefilter					
	--	Filter-B1AF202	30-527	9585	--	\$2.60
	<b>B1AF204</b> <b>785261</b> Heavy-duty air filter for remote air canisters. Fits Hustler Z, Super Z, Mini Z, Super Mini Z, ATZ and Hydro Walk Behind units with Kawasaki 19, 23, 25, 26 HP and Kohler 20, 27, 28, 30 HP engines.					
	4" OD x 2-13/32" ID x 10-1/2" H	Inner Filter-B1AF201	30-055	9583	102-305	\$21.10
	<b>B1AF204B</b> <b>785261</b> Bulk package of B1AF204 (12).					
	4" OD x 2-13/32" ID x 10-1/2" H	--	30-055	9583	102-305	\$198.00
	<b>B1AF201</b> <b>785279</b> Inner filter.					
	--	Filter-B1AF204	30-056	9728	100-780	\$21.70
	<b>B1AF201B</b> <b>785279</b> Bulk package of B1AF201 (12).					
	--	--	30-056	9728	055-165	\$206.40



IHC



	Dimension	Use With	Oregon	Rotary	Stens	Price
	<b>B1SB1384</b> <b>385163R2</b> Replaces Kohler 230840; Tecumseh 30804.					
	4-3/8" OD x 3-1/2" ID x 1-1/2" H	Prefilter-B1SB5934	30-081	1384	100-024	\$3.70
	<b>B1SB5934</b> Prefilter					
	--	Filter-B1SB1384	--	5934	102-343	\$2.00
	<b>B1SB1386 - 385168R2</b> Fits Tecumseh models OH120 thru 175, HH100-115, HH80-120 and VH100-149. For 8 thru 16 HP horizontal engines. Fits Kohler models K241, K301, K321. For 10, 12, 14 HP engines. Replaces Tecumseh 32008; Kohler 235116.					
	6" OD x 4-5/8" ID x 1-7/8" H	Prefilter-B1SB1377	30-080	1386	100-040	\$4.40
	<b>B1SB1377</b> Prefilter. Replaces Kohler 237421; Tecumseh 32906.					
	--	Filter-B1SB1386	--	--	--	\$2.00

Jacobsen

	Dimension	Use With	Oregon	Rotary	Stens	Price
	<b>B1AF109</b> <b>502619</b>					
	3-1/4" OD x 1-11/16" ID x 7-1/2" H	--	30-025	8279	100-465	\$21.80
	<b>B1AF110</b> <b>549593</b>					
	4-1/8" OD x 10-3/8" L	--	30-026	8328	100-519	\$25.90
	<b>B1AF204</b> <b>5000919</b> Fits heavy duty engines with remote air canister.					
	4" OD x 2-13/32" ID x 10-1/2" H	Inner Filter-B1AF201	30-055	9583	102-305	\$21.10
	<b>B1AF204B</b> <b>5000919</b> Bulk package of B1AF204 (12).					
	4" OD x 2-13/32" ID x 10-1/2" H	--	30-055	9583	102-305	\$198.00
	<b>B1AF201</b> Inner Filter					
	--	Filter-B1AF204	30-056	9728	100-780	\$21.70
	<b>B1AF201B</b> Bulk package of B1AF201 (12).					
	--	--	30-056	9728	055-165	\$206.40

## Replacement Air Filters

### Jacobsen

	Dimension	Use With	Oregon	Rotary	Stens	Price
	<b>B1AF244</b> <b>5000913</b> Primary air filter.					
	3-1/2" OD x 1-27/32" ID x 7-1/4" H	Inner Filter-B1AF243	--	9550, 11842	100-533	\$13.10
	<b>B1AF243</b> Inner filter. Fits Engineaire and Kohler CH22-66557, TH16-52527. Replaces 25 083 03S.					
	--	Filter-B1AF244	--	--	100-541	\$9.20

### John Deere

	Dimension	Use With	Oregon	Rotary	Stens	Price
	<b>B1AF270</b> <b>MIU11747</b> Fits Z830A, Z850A, Z860A, Z930A, Z950A, Z960A, Z970A, and Z925A Z-Traks with Kawasaki engines.					
	4.126" OD x 3.189" ID x 10.724" L	Inner Filter-B1AF271	30-157	--	--	\$22.70
	<b>B1AF271</b> <b>MIU11748</b> Prefilter for our B1AF270.					
	3.189" OD	Filter-B1AF270	30-158	--	--	\$18.00
	<b>B1AF294</b> <b>MIU13038</b> Fits Intek engines.					
	--	--	--	--	--	\$6.70
	<b>B1WE7</b> <b>PT4106</b>					
	2-5/8" L x 1-1/4" W x 1-1/4" H	--	55-500	4300	100-297	\$1.70
	<b>B1AF75 - UP06767</b> Fits Homelite 16cc, 25cc and 30cc trimmers, blowers, hedge trimmers, and mini tillers. Also fits models ST145, 155, 175, 185, 285, 385, 485, and Wizard models HB100, HB180 and HB180V. Order in multiples of five.					
	--	--	55-508	8238	100-859	\$1.20
	<b>B1EC24</b> <b>PT8376</b> For backpack blowers. Use with heavy duty filter kit. Fits Echo PB400E and Toro 40cc blowers. Also fits John Deere models 4 and 4E.					
	3-1/4" OD x 1-3/4" ID x 7" L	--	30-143	8585	100-576	\$12.10
	<b>B1AF102</b> <b>AM100137, AM34093</b> Fits models KT317 and 400. For 17 and 20 HP engines. Replaces Wisconsin L0188.					
	4-1/4" OD x 2" ID x 6-1/4" H	--	30-102	8332	100-069	\$7.90
	<b>B115142</b> <b>M152049</b> Fits models FD671D, FD711D, FD750D. Includes prefilter.					
	7-7/8" OD x 5-15/16" ID x 2-13/16" H	Prefilter-B11514	--	10881	102-182	\$28.60

John Deere

	Dimension	Use With	Oregon	Rotary	Stens	Price
	<b>B115143</b> <b>M148207</b> Prefilter. Fits models FD671D, FD711D, FD750D.					
	--	Filter-B115142	--	10882	--	\$1.70
	<b>B1AF171</b> <b>M137556</b> Fits Kawasaki FH-500V engine 17 HP. Replaces Kawasaki 11013-7002					
	8-5/16" L x 3-13/16" W; 6-7/16" W with tab; filter and lip 6-1/2" W x 1-3/16 H	Prefilter-B1AF173	30-322	9506	100-160	\$15.80
	<b>B1AF171B</b> <b>M137556</b> Bulk package of B1AF171 (24). Includes B1AF173 prefilter. Replaces Kwasaki 11013-7001, 11013-7002.					
	8-5/16" L x 3-13/16" W; 6-7/16" W with tab; filter and lip 6-1/2" W x 1-3/16 H	--	30-322	9506	100-160	\$256.80
	<b>B1AF173</b> Prefilter					
	--	Filter-B1AF171	30-940	9611	100-168	\$1.30
	<b>B1AF205</b> <b>M76077</b> Fits Kawasaki FD590V-A504, FD590V-A505 18 HP liquid cooled engine. Replaces Kawasaki 11013-2114, 11013-2115, 11029-2001					
	8-3/4" L x 3-5/8" W x 2-3/4" H	--	30-018	9841	100-238	\$17.60
	<b>B1AF212</b> <b>M115978, M96846, M96847, MIU11377</b> Fits 15, 17 & 19 HP engines. Kawasaki models FD501VCS00. John Deere tractors LX 188 and LX178. Replaces Kawasaki 1029-2006, 11013-2146.					
	6-5/8" L x 3-13/16" W x 3" H	--	30-037	8862	100-256	\$17.10
	<b>B1SB8662</b> <b>M115978, M96846, M96847, MIU11377</b> Fits 15, 17 & 19 HP engines. Kawasaki models FD501VCS00. John Deere tractors LX 188 and LX178. Replaces Kawasaki 1029-2006, 11013-2146. Includes prefilter.					
	6-5/8" L x 3-13/16" W x 3" H	--	30-037	8862	100-256	\$14.90
	<b>B1AF272 - M149118, M146737</b> Fits Kawasaki 20-21 HP models FH601D and FH641D. Fits John Deere models X465, 737, and 757 mid mount Z tracks. Fits Exmark Lazer Z CT with 19HP Kawasaki engines. Replaces Kawasaki 11013-7022					
	8" OD x 5-1/2" ID x 2-1/2" H	--	--	--	--	\$17.00
	<b>B1SB1370</b> <b>AM34963</b> Fits model 60000 to 80000, 100200, 111200, 130200, 131200, 140200. For 2 thru 5 HP horizontal engines. Replaces Briggs & Stratton 27987.					
	4-5/8" to 5-1/4" L x 3-5/8" to 4-1/4" W x 1-1/2" H	--	30-040	1370	100-511	\$5.00
	<b>B1SB1371</b> <b>M47949</b> Fits models 82500 to 82997, 92000 thru 93500. For 3 and 3.5 HP automatic choke vertical engines prior to 1992. Used after code 6808011. Replaces Briggs & Stratton 270579.					
	4-1/2" to 5-3/8" L x 3" to 3-1/2" W x 1-1/2" H	--	30-041	1371	100-529	\$4.60

Replacement Air Filters

John Deere

	Dimension	Use With	Oregon	Rotary	Stens	Price
	<b>B1SB1373</b> <b>AM49396</b> Fits models 146700 thru 147703, 170700, 171700, 190700, 191700, 192700, 193700 series. For 7 and 8 HP vertical engines. Replaces Briggs & Stratton 270528.					
	7-3/4" to 8-1/4" L x 3-5/8" to 4-1/4" W x 1-1/2" H	--	30-043	1373	100-545	\$7.00
	<b>B1SB1376</b> <b>AM37489</b> Fits 100900 series. For 4 HP vertical engines. 270067.					
	5" to 5-5/8" L x 3" to 3-5/8" W x 1-1/2" H	--	30-200	1376	100-578	\$2.90
	<b>B1SB1392</b> <b>M80240</b> Fits (4HP) V40, VH40, (5HP) V50, VH50, (6 HP) VH60, (7 HP) VM70, (8 HP) V80, VM80, V60 thru VM100, V70.					
	6" L x 2-1/2" to 3" W x 1-1/2" H	--	30-060	1392	--	\$2.00
	<b>B1SB1393</b> <b>M44919</b> Fits (3.5 HP) TVS90, (4 HP) TVS105, TVXL105, (5 HP) LAV50, TVS75, TVS120, TVS150.					
	2-7/8" L x 2-3/8" W x 1-7/8" H	--	30-084	1393	--	\$1.50
	<b>B1SB1396</b> <b>M83339</b> Fits models 60100, 80200, 80300, 80400, 81200, 81300, 81400, 92900, 93500, 110900, 112200, 130200 130400, 130900, 131200, 131400, 131900. For 2 thru 5 HP vertical and horizontal engines. Replaces Briggs & Stratton 392308, 392308S.					
	2-3/4" OD x 1-1/4" ID x 2-3/4" H	Prefilter-B1SB1369	30-132	1396	100-081	\$4.30
	<b>B1SB1369</b> <b>PT7946</b> Prefilter. Replaces Briggs & Stratton 270979, 271466.					
	--	Filter-B1SB1396	30-923	1369	100-669	\$1.50
	<b>B1SB1398</b> <b>M82139</b> Fits models 110900, 111900, 112900, 113900, 114900. For 4 HP automatic choke vertical engines. Replaces Briggs & Stratton 270848.					
	4-3/4" to 5-1/2" L x 3-1/4" to 4" W x 1-1/2" H	--	30-202	1398	100-503	\$4.60
	<b>B1SB2774</b> <b>M83646</b> Fits models KT17, KT19, M18 thru 20, K181, K241-341, CH11-14. For 10, 12, 14, 16 HP quiet series engines and 17, 18, 19 and 20 HP twin cylinder engines. Replaces Kohler 47 083 01.					
	7" OD x 5-1/2" ID x 1-3/4" H	Prefilter-B1SB5863	30-098	2774	100-107	\$5.20
	<b>B1SB5863</b> <b>M83681</b> Prefilter. Replaces Kohler 52 083 01.					
	--	Filter-B1SB2774	30-947	5863	102-335	\$2.20
	<b>B1SB2775</b> <b>M49746</b> Fits models HM70, VM80, HM80, H80, HM100. For 7, 8 & 10 HP engines. Replaces Tecumseh 33268					
	4-1/2" L x 2-7/8" W x 2-1/4" H	--	30-100	2775	100-115	\$5.20

John Deere

	Dimension	Use With	Oregon	Rotary	Stens	Price
	<b>B1SB2778</b> <b>AM37816</b> Fits models 220700, 252700, 253700, 256700. For 11 HP IC vertical engines. Replaces Briggs & Stratton 393725.					
	5-3/16" L x 3" W x 2-1/2" H	--	30-105	2778	100-198	\$5.40
	<b>B1SB2788 - PT7953</b> Fits models 60100, 80200, 80300, 80400, 81200, 81300, 81400, 82200, 82300, 82400, 92500, 92900, 110900, 111700, 112200, 112900, 114700, 114900, 130200, 130400, 130900, 131200, 131400, 131900, 132200, 132400, 132900. For 2 thru 5 HP engines. Replaces Briggs & Stratton 396424, 396424S.					
	2-3/4" OD x 1-1/4" ID x 2-3/4" H	Prefilter-B1SB1369	30-094	2788	100-214	\$5.20
	<b>B1SB1369</b> <b>PT7946</b> Prefilter. Replaces Briggs & Stratton 270979, 271466.					
	--	Filter-B1SB2788	30-923	1369	100-669	\$1.50
	<b>B1SB2789 - PT11025, PT15853</b> Fits models 90700, 91700, 95700, 96700, 110700, 111700, 112700, 114700, 130700, 131700. For 3.5 and 4 HP Max series, also used on 4-5 HP 9 CID 2 cycle engines. Replaces Briggs & Stratton 397795.					
	6-5/16" L x 4-1/2" W x 3/4" H	--	30-700	2789	102-533	\$4.70
	<b>B1SB2806</b> <b>AM38990</b> Fits models 400700 thru 422700, 40A700, 42A700, 460700. For 16 and 18 HP vertical twin (L-Head) cylinder engines. Replaces Briggs & Stratton 394019.					
	9-5/8" L x 4" W x 2-1/2" H	Prefilter-B1SB2797	30-104	2806	100-164	\$8.80
	<b>B1SB2797</b> <b>M84655</b> Prefilter. Replaces Briggs & Stratton 271271, 272490.					
	--	Filter-B1SB2806	30-929	2797	100-743	\$3.50
	<b>B1SB2838 - PT15853</b> Fits models 80200, 82200, 112200, 121000, 834000, 121700, 121800, 122700, 123700, 123800, 124700, 124800, 126700, 126800, 125700, 128000, 130200, 132200, 135298. For 3.5 and 6 HP Quantum, 3 and 5 HP IC horizontal, top starter. Replaces Briggs & Stratton 399959, 491588.					
	5-1/4" L x 4-1/2" W x 3/4" H	Prefilter-B1AF81	30-710	2838	102-549	\$4.40
	<b>B1SB2838B</b> <b>PT15853</b> Bulk package of B1SB2838 (60). Replaces Briggs & Stratton 399959, 491588.					
	5-1/4" L x 4-1/2" W x 3/4" H	--	30-710	2838	102-549	\$174.00
	<b>B1AF81</b> <b>271933, 491435</b> Prefilter. Replaces Briggs & Stratton 271933, 491435.					
	--	Filter-B1SB2838	30-927	8481	100-446	\$3.30
	<b>B1SB2840</b> <b>AM37540</b> Fits models 170700, 190700, 191700, 192700, 193700 series. For 7 and 8 HP vertical engines. Replaces Briggs & Stratton 393406.					
	5-3/16" L x 3-1/8" W x 2-1/8" H	--	30-106	2840	100-487	\$5.60
	<b>B1AF209</b> <b>MIU11943</b> Fits Kohler models SV710, SV720, SV730, SV735, and SV740; for Courage twin engines. Includes prefilter. Replaces Kohler 32 08 03-S.					
	5-5/8" L x 4-3/8" W x 1-3/4" H	--	--	11505	100-774	\$12.40

Replacement Air Filters

**John Deere**

	Dimension	Use With	Oregon	Rotary	Stens	Price
	<b>B1SB1388 - AM37201, AM31034</b> Fits Kohler models K341, K321, K482, K532, KT17, KT19, MV16 thru 20, M10 thru M20, CV18 thru CV22. Fits Onan models BF, BFA, BG, BGA, B43, B48. For 16 and 18 HP engines. Replaces Kohler 45 083 02; Onan 140-1216					
	6" OD x 4-5/8" ID x 3" H	Prefilter-B1SB2844	30-093	1388	100-065	\$5.90
	<b>B1SB2844</b> <b>ET12340</b> Prefilter. Replaces Kohler 45 083 01; Onan 140-1218.					
	--	Filter-B1SB1388	30-946	2844	100-768	\$2.70
	<b>B1SB2828</b> <b>M70128, M97266</b> Fits models FC540. Also fits John Deere model 325 and F710. For 17 HP OVH engines Replaces Kawasaki 11013-2143, 11013-2098, 11013-1214.					
	7-1/2" L x 3-1/4" W wide end, 2-1/8" W narrow end x 3-1/16" H	Prefilter-B1SB6517	30-304	2828	102-236	\$13.70
	<b>B1SB6517</b> <b>M70127</b> Prefilter. Replaces Kawasaki 11013-2097.					
	--	Filter-B1SB2828	30-937	6517	102-491	\$1.50
	<b>B1SB6518</b> <b>M70284</b> Fits model FC290Y. Also fits John Deere model RX75. For 9 HP engines. Tear drop shape. Foam gasket top and bottom. Replaces Kawasaki 11013-2093.					
	4-3/4" L x 2-3/4" W x 2-3/4" H	Prefilter-B1SB6519	30-305	6518	100-044	\$9.00
	<b>B1SB6519</b> <b>M70283</b> Prefilter. Replaces Kawasaki 11013-2092.					
	--	Filter-B1SB6518	30-503	6519	100-048	\$1.60
	<b>B1SB6583</b> <b>AM101812</b> Fits P216, P218, P220, P224, P260. For 24 HP engines. Replaces Onan 140-2523, 140-1911 140-2628-02					
	8" OD x 6-1/2" ID x 3-7/8" H	Prefilter-B1SB7209	30-435	6583	102-319	\$7.30
	<b>B1SB7209</b> <b>Prefilter</b>					
	--	Filter-B1SB6583	--	7209	102-137	\$4.80
	<b>B1SB6605</b> <b>M92359, AM121608</b> Fits Command CV11-15 engines. Replaces Kohler 12 083 05.					
	4-5/8" L x 3-3/4" W x 2-13/16" H	Prefilter-B1SB6606	30-085	6605	100-941	\$9.30
	<b>B1SB6606</b> <b>M92360</b> Prefilter. Replaces Kohler 12 083 08					
	--	Filter-B1SB6605	30-942	6606	102-418	\$1.80











## John Deere

	Dimension	Use With	Oregon	Rotary	Stens	Price
	<b>B1SB6705 - M79451</b> Fits models FC150V-AA00, VC150V-AS00 and FC150V-E thru ES05, FC150V-19A00, VC150V-A500. For 4-1/2 and 5 HP vertical engines. For walk-behind mowers. Plastic end caps. Tear drop shape. Replaces Kawasaki 11013-2175, 11013-2120					
	4" L x 2-1/2" W wide end, 1-1/2" W narrow end x 2-1/4" H	Prefilter-B1AF95	30-309	6705	100-188	\$7.10
	<b>B1AF95</b> <b>M77555</b> Prefilter. Replaces Kawasaki 11013-2119, 11013-2174.					
	--	Filter-B1SB6705	30-939	7052	100-202	\$1.50
	<b>B1SB6706</b> <b>AM104560, M97211</b> Fits FC420V. For 14 HP vertical engine. Prefilter included. Replaces Kawasaki 11013-2141					
	6-1/8" L x 2-7/8" W wide end, 2-1/4" W narrow end x 3" H	Prefilter-B1AF96	30-311	6706	100-052	\$9.90
	<b>B1SB2790</b> <b>AM106953</b> Fits models NHC, T260, NHA, NHB, B43, P216, P218, P220, P224. For 16 thru 20 HP engines. Replaces Onan 140-1228, 140-2522, 140-2628.					
	8" OD x 6-5/8" ID x 2-1/8" H	Prefilter-B1SB7050	30-430	2790	100-149	\$5.70
	<b>B1SB7050</b> <b>HE140-1496</b> Prefilter. Replaces Onan 140-1496.					
	--	Filter-B1SB2790	30-011	7050	100-875	\$2.80
	<b>B1SB8662</b> <b>M115978, M96847</b> Fits models FD440 B and C. Replaces Kawasaki 11013-2135.					
	7" L x 3-5/8" W x 2-1/2" H	--	30-037	8662	--	\$14.90
	<b>B1AF164</b> <b>GY21055</b> Fits models 31L777, 31M977, 31Q777, 331707, 331777, 331807, 331877, 33M677, 33M777. Fits ELS (Extended Life Series) with 17.5 HP, 18.5 HP and 21 HP. Includes prefilter.					
	2-15/16" L x 2-15/16" W x 5-7/8" H	--	--	--	100-929	\$13.60
	<b>B1AF113</b> <b>MIU11286</b> Fits Intek V-twin OHV engines 14 thru 24 HP.					
	7" L x 4" W x 1-1/2" H	Prefilter-B1AF104	30-032	9273	100-153	\$8.40
	<b>B1AF104</b> <b>LG273638S</b> Prefilter					
	--	Filter-B1AF113	--	9304	100-176	\$2.80
	<b>B1AF109</b> <b>AM108243, M75144, CH15451</b>					
	3-1/4" OD x 1-11/16" ID x 7-1/2" L	--	30-025	8279	100-465	\$21.80
	<b>B1AF110</b> <b>CH12767</b> Fits some Compact Utility Tractoris and Excavators.					
	4-1/8" OD x 10-3/8" L	--	30-026	8328	100-519	\$25.90

Replacement Air Filters

John Deere

	Dimension	Use With	Oregon	Rotary	Stens	Price
	<b>B1AF204</b> <b>M131802, M144100, RG60690</b>					
	4" OD x 2-13/32" ID x 10-1/2" H	Inner Filter-B1AF201	30-055	9583	102-3205	\$21.10
	<b>B1AF204B</b> <b>M131802, M144100, RG60690</b> Bulk package of B1AF204 (12).					
	4" OD x 2-13/32" ID x 10-1/2" H	--	30-055	9583	102-305	\$198.00
	<b>B1AF201</b> <b>M131803, M144098, RG60866</b> Inner filter.					
	--	Filter-B1AF204	30-056	9728	100-780	\$21.70
	<b>B1AF201B</b> <b>M131803, M144098, RG60866</b> Bulk package of B1AF201 (12).					
	--	--	30-056	9728	055-165	\$206.40
	<b>B1AF244</b> <b>M113621</b> Primary air filter. Replaces Kohler 25 083 02S.					
	3-1/2" OD x 1-27/32" ID x 7-1/4" H	Inner filter-B1AF243	--	9550, 11842	100-533	\$13.10
	<b>B1AF243</b> <b>M123378</b> Inner filter. Engineaire and Kohler CH22-66557, TH16-52527. Replaces Kohler 25 083 03S.					
	--	Filter-B1AF244	--	--	100-541	\$9.20
	<b>B1AF280</b> <b>AM101191</b> Fits model FB460. For 12.5 HP engines. Replaces Kawasaki 11013-2021.					
	7" L x 2-1/4" W x 2-3/4" H	Prefilter-B1SB5861	30-303	6567	100-347	\$9.80
	<b>B1SB5861</b> <b>M88571</b> Prefilter. Replaces Kawasaki 11013-2020.					
	--	Filter-B1AF280	30-935	5861	100-354	\$1.90
	<b>B1AF313</b> <b>M71952</b> For 5.2 HP engines. Fits model FA210. Replaces Kawasaki 49064-2059, 3144AA-1312A.					
	2-15/16" OD x 1-7/8" H, base 4-7/8" L x 4-1/4" W	--	30-313	7714	--	\$13.50
	<b>B1SB1374 - PT9334</b> Fits models 170400, 171400, 190400, 195400, 220400, 221400, 222400, 233400, 243400, 252400, 253700, 254400, 290400, 294400, 302400, 303400, 326400. Fits 7 thru 18 HP horizontal engines. Replaces Briggs & Stratton 390930, 393957, 393957S.					
	4-1/4" OD x 2" ID x 3-3/4" H	Prefilter-B1SB2786	30-044	1374	100-073	\$5.80

**John Deere**

	Dimension	Use With	Oregon	Rotary	Stens	Price
	<b>B1SB2786</b> <b>M96098</b> Prefilter. Replaces Briggs & Stratton 270782, 271794, 271794S.					
	--	Filter-B1SB1374	30-920	2786	100-685	\$3.80
	<b>B1SB1384</b> <b>AM31034</b> Replaces Kohler 230840; Tecumseh 30804.					
	4-3/8" OD x 3-1/2" ID x 1-1/2" H	Prefilter-B1SB5934	30-081	1384	100-024	\$3.70
	<b>B1SB5934</b> Prefilter					
	--	Filter-B1SB1384	--	5934	102-343	\$2.00
	<b>B1SB1385</b> <b>AM30800</b> Replaces Kohler 231847, 25-883-01; Tecumseh 31925.					
	4-3/4" OD x 3" ID x 2-1/4" H	Prefilter-B1SB2780	30-082	1385	100-032	\$4.60
	<b>B1SB2780</b> Prefilter					
	--	Filter-B1SB1385	30-125	2780	102-350	\$2.30
	<b>B1SB1386 - AM31400</b> Fits Tecumseh models OH120 thru 175, HH100-115, HH80-120 and VH100-149. For 8 thru 16 HP Horizontal engines. Fits Kohler models K241, K301, K321. For 10, 12, 14 HP engines. Replaces Tecumseh 32008; Kohler 235116.					
	6" OD x 4-5/8" ID x 1-7/8" H	Prefilter-B1SB1377	30-080	1386	100-040	\$4.40
	<b>B1SB1377</b> <b>M45800</b> Prefilter. Replaces Kohler 237421; Tecumseh 32906.					
	--	Filter-B1SB1386	30-941	1377	100-750	\$2.00
	<b>B1SB1389</b> <b>M47494</b> Fits models K241, K301, K321, and K 361. 10 thru 20 HP engines, Replaces Kohler 47 083 3					
	7" OD x 5-5/8" ID x 2-1/2" H	--	30-095	1389	100-016	\$5.00
	<b>B1SB1390</b> <b>AM30900</b> Fits models LAV, VH40 thru 70, HH60 thru 70, HM80, HS40 thru 50. For 3 thru 8 HP and most vertical and horizontal shaft engines. Metal top. Replaces Tecumseh 30727.					
	3-3/4" OD x 2-3/8" ID x 2" H	--	30-070	1390	100-008	\$3.50

**Kawasaki**

	Dimension	Use With	Oregon	Rotary	Stens	Price
	<b>B1AF272</b> <b>11013-7011, 11013-7022</b> Fits Kawasaki 20-21 HP models FH601D and FH641 D. Fits John Deere models X465, 737, and 757 mid mount Z tracks. Fits Exmark Lazer Z CT with 19 HP Kawasaki engines.					
	8" OD x 5-1/2" ID x 2-1/2" H	--	--	--	--	\$17.10

Replacement Air Filters

**Kawasaki**





	Dimension	Use With	Oregon	Rotary	Stens	Price
	<b>B115142</b> <b>11013-2186, 11013-2195, 11013-2213</b> Fits models FD671D, FD711D, FD750D. Includes prefilter.					
	7-7/8" OD x 5-15/16" ID x 2-13/16"	Prefilter-B115143	--	10881	102-182	\$28.60
	<b>B115143</b> <b>11013-2194</b> Prefilter. Fits models FD671D, FD711D, FD750.					
	--	Filter-B115142	--	10882	--	\$1.70
	<b>B1AF241</b> <b>11013-7031, 11013-7026</b> Air Filter for Kawasaki FH430V/480/541/580V.					
	7-3/8" L x 3-1/2" W x 2-5/16" H	--	--	11230	102-370	\$17.20
	<b>B1AF205</b> <b>11013-2114, 11013-2115, 11029-2001</b> Fits Kawasaki FD590V-A504, FD590V-A505 18 HP liquid cooled engine.					
	8-3/4" L x 3-5/8" W x 2-3/4" H	--	30-018	9841	100-238	\$17.60
	<b>B1AF212</b> <b>11013-2134, 11013-2135, 11013-2146, 11013-2206, 11029-2006, 11029-2018</b> Fits 15, 17, & 19 HP engines. Kawasaki models FD501V-CS00.					
	6-5/8" L x 3-13/16" W x 3" H	--	30-037	8862	100-256	\$17.10
	<b>B1SB8662</b> <b>11013-2134, 11013-2135, 11013-2146, 11013-2206, 11029-2006, 11029-2018</b> Fits 15, 17, & 19 HP engines. Kawasaki models FD501V-CS00. Includes prefilter.					
	6-5/8" L x 3-13/16" W x 3" H	Prefilter-B1SB8505	30-037	8662	100-256	\$14.90
	<b>B1SB8505</b> <b>11013-2134</b> Prefilter.					
	--	Filter-B1SB8662	--	8505	--	\$2.10
	<b>B1AF122</b> <b>11029-2005, 11013-2139</b> Fits model FD620 and KD620D. For 20-25 HP twin cylinder. Plastic end caps					
	7-15/16" L x 4-1/2" W x 2-7/16" H	Prefilter-B1AF123	30-321	--	100-210	\$16.50
	<b>B1AF123</b> <b>11013-2114</b> Prefilter. Fits FD620 engine on Scag mowers.					
	--	Filter-B1AF122	30-329	9292	--	\$3.00
	<b>B1AF202</b> <b>11013-7003, 11013-7005, 11013-7009, 11013-7010, 11013-7024, 11029-7001, 11029-7002, 11029-7012</b> Fits FH601V, FH641V, FH680V, and FH721V engines with 23 HP.					
	7-1/4" L x 3-1/4" W x 3-1/8" H	Prefilter-B1AF286	30-054	9584	100-622	\$16.50
	<b>B1AF286</b> <b>11013-7009</b> Prefilter					
	--	Filter-B1AF202	30-527	9585	--	\$2.60

## Kawasaki

	Dimension	Use With	Oregon	Rotary	Stens	Price
	<b>B1AF313</b> <b>49064-2059, 3144AA-1312A</b> For 5.2 HP engines. Fits model FA210.					
	2-15/16" OD x 1-7/8" H / base 4-7/8" L x 4-1/4" W	Prefilter-B1SB7841	30-313	7714	--	\$13.50
	<b>B1SB7841</b> <b>11013-2010</b> Prefilter					
	--	Filter-B1AF313	--	7841	--	\$2.40
	<b>B1SB6518</b> <b>11013-2093</b> Fits model FC290Y. Also fits John Deere model RX75. For 9 HP engines. Tear drop shape. Foam gasket top and bottom.					
	4-3/4" L x 2-3/4" W x 2-3/4" H	Prefilter-B1SB6519	30-305	6518	100-044	\$9.00
	<b>B1SB6519</b> <b>11013-2092</b> Prefilter.					
	--	Filter-B1SB6518	30-503	6519	100-048	\$1.60
	<b>B1SB6705</b> <b>11013-2175, 11013-2120</b> Fits models FC150V-AA00, VC150V-AS00 and FC150V-E thru ES05, FC150V-19A00 VC150V-A500. For 4-1/2 and 5 HP vertical engines. For walk-behind mowers. Plastic end caps. Tear drop shape.					
	4" L x 2-1/2" W wide end, 1-1/2" W narrow end x 2-1/4" H	Prefilter-B1AF95	30-309	6705	100-188	\$7.10
	<b>B1AF95</b> <b>11013-2119, 11013-2174</b> Prefilter.					
	--	Filter-B1SB6705	30-939	7052	100-202	\$1.50
	<b>B1SB6706</b> <b>11013-2110, 11013-2141</b> Fits FC420V. For 14 HP vertical engine. Prefilter included.					
	6-1/8" L x 2-7/8" W wide end, 2-1/4" W narrow end x 3" H	Prefilter-B1AF96	30-311	6706	100-052	\$9.90
	<b>B1AF280</b> <b>11013-2021</b> Fits model FB460. For 12.5 HP engines.					
	7" L x 2-1/4" W x 2-3/4" H	Prefilter-B1SB5861	30-303	6567	100-347	\$9.90
	<b>B1SB5861</b> <b>11013-2020</b> Prefilter.					
	--	Filter-B1AF280	30-935	5861	100-354	\$1.90
	<b>B1SB2828</b> <b>11013-1214, 11013-2098, 11013-2143</b> Fits model FC540. Also fits John Deere model 325 and F710. For 17 HP OHV engines.					
	7-1/2" L x 3-1/4" W wide end, 2-1/8" W narrow end x 3-1/16" H	Prefilter-B1SB6517	30-304	2828	102-236	\$13.70





Replacement Air Filters

**Kawasaki**







	Dimension	Use With	Oregon	Rotary	Stens	Price
 <p><b>B1SB6517</b> <b>11013-2097</b> Prefilter.</p>	--	Filter-B1SB2828	30-937	6517	102-491	\$1.50
 <p><b>B1AF214</b> <b>11013-7017</b> Fits 15 HP engines. Models FH430V-AS12 and FH381-V.</p>	7-3/8" L x 4-3/8" W x 1" H	Prefilter-B1AF218	--	10313	102-354	\$12.30
 <p><b>B1AF218</b> <b>11013-7016</b> Prefilter</p>	--	Filter-B1AF214	--	10305	--	\$1.10
 <p><b>B1AF217</b> <b>11029-7010</b> Fits 6.5 HP engines. Model FJ180V-AS04.</p>	7-3/8" L x 2-11/16" W x 1" H	--	--	10398	054-167	\$8.50
 <p><b>B1AF171</b> <b>11013-7002</b> Fits Kawasaki FH-500V engine 17 HP.</p>	8-5/16" L x 1-3/16" H x 3-13/16" W; 6-7/16" W with tab; filter and lip 6-1/2" W	Prefilter-B1AF173	30-322	9506	100-160	\$15.80
 <p><b>B1AF171B</b> <b>11013-7002</b> Bulk package of B1AF171 (24). Includes B1AF173 prefilter.</p>	8-5/16" L x 1-3/16" H x 3-13/16" W; 6-7/16" W with tab; filter and lip 6-1/2" W	--	30-322	9506	100-160	\$256.80
 <p><b>B1AF173</b> <b>11013-7001, 11013-7033</b> Prefilter.</p>	--	Filter-B1AF171	30-940	9611	100-168	\$1.25
 <p><b>B1AF204</b> <b>11013-7020, 11013-7044</b> Fits FD671D, FD731V, FD750D, FD791D, FD851D, FH601V, FH641V, FH680V, FH721V, and FH770D engines.</p>	4" OD x 2-13/32" ID x 10-1/2" H	Inner Filter-B1AF201	30-055	9583	102-305	\$21.10
 <p><b>B1AF204B</b> <b>11013-7020, 11013-7044</b> Bulk package of B1AF204 (12).</p>	4" OD x 2-13/32" ID x 10-1/2" H	--	30-055	9583	102-305	\$198.00
 <p><b>B1AF201</b> <b>11013-7019, 11013-7045</b> Inner filter.</p>	--	Filter-B1AF204	30-056	9728	100-780	\$21.70
 <p><b>B1AF201B</b> <b>11013-7019, 11013-7045</b> Bulk package of B1AF201 (12).</p>	--	--	30-056	9728	055-165	\$206.40



**Kawasaki**

	Dimension	Use With	Oregon	Rotary	Stens	Price
	<b>B1AF244</b> <b>11013-1290, 11013-7029, 11013-7048</b> Heavy-duty air filter for remote air canisters.					
	4" OD x 2-13/32" ID x 10-1/2" H	Inner Filter-B1AF201	--	9550	100-533	\$13.10
	<b>B1AF243</b> Inner Filter.					
	--	Filter-B1AF204	--	--	100-541	\$9.20
	<b>B1AF270</b> <b>11013-7038</b> Fits FX751V, FX801V, FX850V, FX921V, and FXT00V engines.					
	4.126" OD x 3.189" ID x 10.724" L	Inner Filter-B1AF271	30-157	--	--	\$22.70
	<b>B1AF271</b> <b>11013-7039</b> Prefilter to our B1AF270					
	3.189" OD	Filter-B1AF270	30-158	--	--	\$18.00
	<b>B1AF274</b> <b>11013-7047, 11013-7049</b> Fits models FS481V, FS541V, FS600V, FS730V, FR651V and FR691V					
	6-5/8" L x 2-3/4" W x 3" H	--	--	--	054-259	\$9.30

**Kohler**

	Dimension	Use With	Oregon	Rotary	Stens	Price
	<b>B1AF209</b> <b>32 083 03 S</b> Fits models SV710, SV720, SV730, SV735 and SV740; for Courage twin engines. Includes prefilter.					
	5-5/8" L x 4-3/8" W x 1-3/4" H	Prefilter-B1SB7043	--	11505	100-774	\$12.40
	<b>B1SB7043</b> Prefilter.					
	--	Filter-B1AF209	--	7043	100-432	\$1.90
	<b>B1AF224</b> <b>28 083 03</b> Fits TH16-18 OHV Command series engines.					
	9-1/4" L x 6-7/8" W x 1-1/2" H	Prefilter-B1AF225	30-023	7035	102-309	\$9.90
	<b>B1AF225</b> <b>28 083 02</b> Prefilter					
	--	Filter-B1AF224	--	10212	102-331, 102-513	\$1.40
	<b>B1AF227</b> <b>28 083 06</b> Prefilter.					
	--	Filter-B1AF226	--	10213	055-097	\$1.90
	<b>B1AF8235</b> <b>12 083 10</b> Fits CV11, CV12.5, CV14, and CV15T commercial walk-behinds.					
	4-9/16" OD x 3-3/4" ID x 3-5/16" H	Prefilter-B1SB8712	30-088	8235	100-957	\$7.40

Replacement Air Filters

**Kohler**





	Dimension	Use With	Oregon	Rotary	Stens	Price
	<b>B1SB8712</b> 12 083 12 Prefilter. Fits CV11 and CV14 engines.					
	--	Filter-B1AF8235	30-943	8712	100-953	\$1.70
	<b>B1SB1389</b> 47 083 03, 47 883 03 Fits models K241, K301, K321, and K361. 10 thru 20 HP engines.					
	7" OD x 5-5/8" ID x 2-1/2" H	Prefilter-B1SB7785	30-095	1389	100-016	\$5.00
	<b>B1SB7785</b> 41 083 04, 24 083 02 Prefilter.					
	--	Filter-B1SB1389	30-944	7785	102-331	\$2.70
	<b>B1SB1388</b> 45 083 02 Fits models K341, K321, K482, K532, KT17, KT19, MV16 thru 20, M10 thru M20, CV18 thru CV22.					
	6" OD x 4-5/8" ID x 3" H	Prefilter-B1SB2844	30-093	1388	100-065	\$5.90
	<b>B1SB2844</b> 45 083 01 Prefilter					
	--	Filter-B1SB1388	30-946	2844	100-768	\$2.70
	<b>B1AF8329</b> 24 083 03 Fits CH25 command 25 HP OHV engine. Also fits CV18 thru CV26.					
	7" OD x 5-1/2" ID x 3" H	Prefilter-B1AF8966	30-089	8329	100-758	\$7.40
	<b>B1AF8966</b> 24 083 05 Prefilter.					
	--	Filter-B1AF8329	30-945	8966	100-754	\$2.00
	<b>B1SB1386</b> 235116 Fits K241, K301, K321 and M8-14 Magnum engines.					
	6" OD x 4-5/8" ID x 1-7/8" H	Prefilter-B1SB1377	30-080	1386	100-040	\$4.40
	<b>B1SB1377</b> 237421 Prefilter.					
	--	Filter-B1SB1386	30-941	1377	100-750	\$2.00
	<b>B1SB1384</b> 230840, 15 083 06 Fits models K91 thru K161.					
	4-3/8" OD x 3-1/2" ID x 1-1/2" H	Prefilter-B1SB5934	30-081	1384	100-024	\$3.70
	<b>B1SB5934</b> 234870 Prefilter.					
	--	Filter-B1SB1384	--	5934	102-343	\$2.00

## Kohler

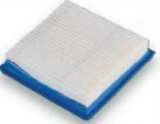

	Dimension	Use With	Oregon	Rotary	Stens	Price
	<b>B1SB1385</b> <b>231847, 25 883 01</b> Fits model K161, K181, 7 and 8 HP engines. Also fits El Smith air compressor 2557, Rol-Air air compressor 431.					
	4-3/8" OD x 3" ID x 2-1/4" H	Prefilter-B1SB2780	30-082	1385	100-032	\$4.60
	<b>B1SB2780</b> <b>234869</b> Prefilter.					
	--	Filter-B1AF1385	30-125	2780	102-350	\$2.30
	<b>B1SB1387</b> <b>277138</b> Fits models K532, K582, K482 and K301, K321. For 12, 14, 18, 20 and 23 HP engines.					
	6" OD x 4-3/4" ID x 4" H	Prefilter-B1SB6516	30-092	1387	100-057	\$5.60
	<b>B1SB6516</b> <b>277593</b> Prefilter.					
	--	Filter-B1SB1387	30-129	6516	--	\$1.80
	<b>B1SB2774</b> <b>47 083 01</b> Fits models KT17, KT19, M18 thru 20, K181, K241-341, CH11-14. For 10, 12, 14, 16 HP quiet series engines, and 17, 18, 19 and 20 HP twin cylinder engines.					
	7" OD x 5-1/2" ID x 1-3/4" H	Prefilter-B1SB5863	30-098	2774	100-107	\$5.20
	<b>B1SB5863</b> <b>52 083 01</b> Prefilter					
	--	Filter-B1SB2774	30-947	5863	102-335	\$2.20
	<b>B1SB6605</b> <b>12 083 05</b> Fits Command CV 11-15 engines.					
	4-5/8" L x 3-3/4" W x 2-13/16" H	Prefilter-B1SB6606	30-085	6605	100-941	\$9.30
	<b>B1SB6606</b> <b>12 083 08</b> Prefilter					
	--	Filter-B1SB6605	30-942	6606	102-418	\$1.80
	<b>B1AF244</b> <b>25 083 02 S</b> Primary air filter for Kohler CH25, CH26, and TH16.					
	3-1/2" OD x 1-27/32" ID x 7-1/4" H	Inner Filter-B1AF243	--	9550	100-533	\$13.10
	<b>B1AF243</b> <b>25 083 03 S</b> Inner filter. Fits Kohler CH22-66557, TH16-52527.					
	--	Filter-B1AF244	--	--	100-541	\$9.20
	<b>B1AF204</b> <b>25 083 01</b> Fits model CH18S thru CH26S Command Pro 23 & 25 HP engines. Heavy-duty air filter.					
	4" OD x 2-13/32" ID x 10-1/2" H	Inner Filter-B1AF201	30-055	9583	102-305	\$21.10

Replacement Air Filters







**Kohler**

	Dimension	Use With	Oregon	Rotary	Stens	Price
 <p><b>B1AF204B</b> 25 083 01 Bulk package of B1AF204 (12)</p>	4" OD x 2-13/32" ID x 10-1/2" H	--	30-055	9583	102-305	\$198.00
	<p><b>B1AF201</b> 25 083 04 Inner filter</p>					
	--	Filter-B1AF204	30-056	9728	100-780	\$21.70
 <p><b>B1AF201B</b> 25 083 04 Bulk package of B1AF201 (12)</p>	<p>--</p>					
	--	--	30-056	9728	055-165	\$206.40
 <p><b>B1AF7980</b> 14 083 01-S, 14 083 01-S1, 14 083 04-S Fits Honda code 4527479. Fits SX series, Harmony 215, HRM215, HRB215, HR215K1.</p>	5-3/4" L x 3-1/2" W x 1" H	Prefilter-B1AF7979	30-709	7980	100-378	\$8.50
	<p><b>B1AF7979</b> 14 083 02-S Prefilter.</p>					
	5-1/2" L x 3-1/4" W x 1/4" H	Filter-B1AF7980	30-932	7979	--	\$0.90
 <p><b>B1SB7123</b> 15 083 01 Fits models M5, 5 HP engines.</p>	<p>4" L x 4" W x 7/8" H</p>					
	--	--	--	7123	--	\$5.80
 <p><b>B1AF232</b> 20 283 02 Fits models SV470S, SV480, SV530S, SV540S, SV590S, SV600S, and SV610 Courage single series; for 15 thru 17 HP engines.</p>	<p>8" L x 7-3/4" W x 1-1/2" H</p>					
	--	--	--	11466	--	\$12.90
 <p><b>B1AF261</b> 32 083 06 S Fits SV810-SV830 series engines. Taller version of our B1AF209.</p>	5-3/4" x 4-3/8" OD x 4" x 2-3/4" ID x 3-1/8" H	Prefilter-B1AF275	--	12674	100-766	\$11.50
	<p><b>B1AF275</b> 32 083 08 S Fits SV810-SV830 series engines.</p>					
	--	Filter-B1AF261	--	12676	100-770	\$1.70



**Kubota**

	Dimension	Use With	Oregon	Rotary	Stens	Price
 <p><b>B1SB7046</b> 12681-11220 Used on 5 HP self-propelled mowers.</p>	<p>8" L x 2-1/8" W x 2" H</p>					
	Prefilter-B1SB7047	30-316	7046	--	\$14.20	
 <p><b>B1SB7047</b> Prefilter</p>	<p>--</p>					
	Filter-B1SB7046	--	7047	--	\$2.10	

**Kubota**



	Dimension	Use With	Oregon	Rotary	Stens	Price
 <p><b>B1AF109</b>  <b>15222-11221, 70000-11221</b> Cyclonic filter. Kubota B series below 20 HP, Models B5100, B5200, B6100, B6100DT, B6100HST, B7100, B7100DT, B7100HST, B8200HST, L225, L225DT, L235, L245, L245DT, L245H, L260H, L275. Fits Gravely Prometer 350 with Kubota 30 HP engine.</p>	3-1/4" OD x 1-11/16" ID x 7-1/2" L	--	30-025	8279	100-465	\$21.80
 <p><b>B1AF110</b>  <b>70000-11081</b> Cyclonic filter. "L" series 20 HP and above.</p>	4-1/8" OD x 10-3/8" L	--	30-026	8328	100-519	\$24.30
 <p><b>B1SB8327</b>  <b>15852-11083, 15852-11081</b> Cyclonic filter. Fits models B20, B1550, B1750, D, E, HSD, HSE, HST, G1800S, G-1900HST, G-2000, G-2000S, G-3200, G4200H, G-5200H, G-6200H.</p>	3-1/4" OD/5" OD bottom x 1-11/16" ID x 7-1/4" H	--	30-019	8327	100-469	\$30.60
 <p><b>B1AF204</b>  <b>TA040-93230</b></p>	4" OD x 2-13/32" ID x 10-1/2" H	Inner Filter-B1AF201	30-055	9583	102-305	\$21.10
 <p><b>B1AF204B</b>                      Bulk package of B1AF204 (12)</p>	4" OD x 2-13/32" ID x 10-1/2" H	--	30-055	9583	102-305	\$198.00
 <p><b>B1AF201</b>  <b>TA040-93220</b> Inner filter.</p>	--	Filter-B1AF204	30-056	9728	100-780	\$21.70
 <p><b>B1AF201B</b>  <b>TA040-93220</b> Bulk package of B1AF201 (12)</p>	--	--	30-056	9728	055-165	\$203.40

**Kubota**

	Dimension	Use With	Oregon	Rotary	Stens	Price
 <p><b>B1AF244</b>  <b>1G659-11222, K1211-82320, K2581-82311</b> Fits models BX1500D, BX1800D, BX1830D, BX2200D, BX2230D, BX22D, BX23D.</p>	3-1/2" OD x 1-27/32" ID x 7-1/4" H	Inner Filter-B1AF243	--	9550	100-533	\$13.10
 <p><b>B1AF243</b>  <b>32721-58240, 32821-58242, K7561-82360</b> Inner filter for B1AF244</p>	--	Outer Filter-B1AF244	--	--	100-541	\$9.20
 <p><b>B1VPD7398</b>  <b>K1211-82320</b> Fits models BX1500D, BX1800D, BX1830D, BX2200D, BX2230D, BX22D, BX23D.</p>	6.97" L x 3.66" W	--	--	--	--	\$14.10







Replacement Air Filters

**Kubota**



	Dimension	Use With	Oregon	Rotary	Stens	Price
 <p><b>B1VPD7027</b> <b>15606-11080</b> Outer Air Filter</p>						
	11.44" L x 6.38" W	Inner Filter- B1VPD7142	--	--	--	\$21.40
 <p><b>B1VPD7142</b> <b>17381-11180</b> Inner Air Filter. Fits models L2850DT, L2850F, L3250DT, L3250F, L3350DT, L3750, L3750DT, L4150, L4150DT, L4150DTN, L5450DT.</p>						
	10.08" L x 2.48" W	Outer Filter-B1VPD7027	--	--	--	\$26.30
 <p><b>B1VPD7381</b> <b>R1401-42270</b> Outer Air Filter</p>						
	--	Inner Filter-B1VP7378	--	--	--	\$28.50
 <p><b>B1VPD7378</b> <b>R2401-42280</b> Inner Air Filter. Fits models L48, L5030GST, L5030HST, L5030HSTC.</p>						
	11.73" L x 3.23" W	Outer Filter-B1VPD7381	--	--	--	\$17.40
 <p><b>B1VPD7390</b> <b>15287-11080</b> Outer Air Filter</p>						
	10.38" L x 5.15" W	Inner Filter-B1VPD7391	--	--	--	\$21.40
 <p><b>B1VPD7391 - 15287-11490</b> Inner Air Filter. Fits models L2250DT, L2250F, L2550DT, L2550F, L2650DT, L2650DTGST, L2650DTWET, L2650F, L275, L2850DT, L2950DT, L2950DTGST, L2950DTWET, L2950F, L295DT, L295F, L305DT, L305F, L3250DT, L345, L3450DT, L3450DTGST, L3450DTWET, L3450F, L345DT, L3650DT, L3650DTGST, L3650DTWE, L3650F.</p>						
	9.13" L x 2.48" W	Outer Filter-B1VPD7390	--	--	--	\$41.80
 <p><b>B1VPD7394</b> <b>TC020-16320</b> Outer Air Filter</p>						
	--	Inner Filter-B1VP7395	--	--	--	\$15.70
 <p><b>B1VPD7395</b> <b>T0270-93220</b> Inner Air Filter. Fits models ST30, ST35, STV32, STV36, STV40.</p>						
	9.02" L x 2.13" W	Outer Filter-B1VPD7394	--	--	--	\$25.60
 <p><b>B1VP7377</b> <b>6C040-94240</b> Outer Air Filter.</p>						
	--	Inner Filter-B1VPD7396	--	--	--	\$24.30
 <p><b>B1VP7396</b> <b>6C040-94250</b> Inner Air Filter. Fits models B1700D, B1700E, B1700HSD, B1700HSE, B2100D, B2100E, B2100HSD, B2100HSE, B2400D, B2400E, B2400HSD, B2400HSE.</p>						
	6.22" L x 2.17" W	Outer Filter-B1VPD7377	--	--	--	\$19.20



**Kubota**



	Dimension	Use With	Oregon	Rotary	Stens	Price
 <p><b>B1VPD7258 - 17325-11080</b> Fits models L2250DT, L2250F, L2550DT, L2550DTGST, L2550F, L2550TOW, L2650DT, L2650DTGST, L2650DTWET, L2650F, L2850DT, L285P, L285WP, L2950DT, L2950DTGST, L2950DTWET, L2950F, L2950DT, L295F, L305DT, L305F, L3250DT, L345, L3450DT, L3450DTGST, L3450DTWET, L3450F, L345DT, L355SS, L3650DT, L3650DTGST, L3650DTWET, L3650F.</p>	10.63" L x 5.51" W	--	--	--	100-519	\$15.60
 <p><b>B1VPD7261</b> <b>15852-11080</b> Fits models B1550D, B1550HSTD, B1550HSTE, B1750D, B1750E, B1750HSTD, B1750HSTE, B20.</p>	7.36" L x 4.88" W	--	--	--	--	\$18.10
 <p><b>B1VPD7263 - 19215-11220</b> Fits model B4200D, B5200D, B5200E, B6100DP, B6100EP, B6100HSTD, B6100HSTE, B6200D, B6200E, B6200HSTD, B6200HSTE, B7100HSTD, B7100HSTE, B7200E, B7200HSTD, B7200HSTE, B7300HSD, B8200DP, B8200EP, B8200HSTD, B8200HSTEP, L185DT, L185F, L2050DT, L2050F, L235, L2350DT, L2350F, L245DT, L245F, L245H</p>	7.32" L x 4.13" W	--	--	--	--	\$21.40
 <p><b>B1VPD7373</b> <b>67980-82630</b> Fits models B1700D, B1700E, B1700HSD, B1700HSE, B2100D, B2100E, B2100HSD, B2400D, B2400HSD, B2400HSE.</p>	7.28" L x 3.35" W	--	--	--	--	\$24.70
 <p><b>B1VPD7374</b> <b>15741-11083</b> Fits models B9200DCDP, B9200DCEP, B9200HSDTOW, B9200HSTD, B9200HSTEP.</p>	10.35" L x 5.75" W	--	--	--	--	\$26.30
 <p><b>B1VPD7393 - T0070-16323</b> Fits model L2500DT, L2500F, L2600DT, L2600F, L2900DT, L2900DTGST, L2900F, L3000DT, L3000F, L3300DT, L3300DTGST, L3300F, L35, L3600DT, L3600DTC, L3600DTGST, L4200DT, L4200DTC, L4200DTGST, L4200DTGSTC, L4200F, L4200FGST.</p>	9.96" L x 4.09" W	--	--	--	--	\$27.20
 <p><b>B1VPD7397- 6C060-99410</b> Fits models B1410, B1610, B1710D, B21, B2100D, B2100E, B2100HSE, B2400D, B2400E, B2410HSD, B2410HSDB, B2410HSE, B2710HSD, B7400HSD, B7410D, B7500D, B7500HSD, B7610HSD, B7800HSD.</p>	7" L x 3.5" OD	--	--	--	--	\$21.90

**Lawn Boy**



	Dimension	Use With	Oregon	Rotary	Stens	Price
 <p><b>B1SB2779</b> <b>602016</b> Fits C and D series engines.</p>	2-1/4" W x 1-7/16" H	--	30-053	2779	--	\$1.50
 <p><b>B1SB1380</b> <b>609493</b> Fits F series engines from 1978 and up.</p>	4-1/2" L x 2-1/2" W x 1" H	--	30-950	1380	100-586	\$1.20

Replacement Air Filters



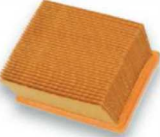

**Lawn Boy**

	Dimension	Use With	Oregon	Rotary	Stens	Price
	<b>B1SB1379</b> <b>607580</b> Fits D series engines 1977 and older.					
	4-1/16" L x 2-1/8" W x 1" H	--	30-949	1379	100-602	\$1.00
	<b>B1SB1378</b> <b>604274</b> Fits C, D, and F series engines 1977 and older.					
	3-1/4" OD x 1-1/4" H	--	30-948	1378	100-594	\$1.70

**Makita**

	Dimension	Use With	Oregon	Rotary	Stens	Price
	<b>B1AF151</b> <b>391-173-010, 394-173-010, 957-173-720</b> Fits models DPC6300, 6200, 6201, 7300C					
	4-1/8" L x 3" W x 2-3/8" H	Prefilter-B1AF152	--	9957	605-840	\$11.80
	<b>B1AF152</b> <b>391-173-030, 394-173-030</b> Prefilter					
	5-3/8" L x 3-1/4" W x 3/4" H	Filter-B1AF151	--	9958	605-361	\$4.90

**Massey Ferguson**

	Dimension	Use With	Oregon	Rotary	Stens	Price
	<b>B1SB1384</b> <b>1035-991-M1</b> Fits models K91 thru K161. Replaces Kohler 230840.					
	4-3/8" OD x 3-1/2" ID x 1-1/2" H	Prefilter-B1SB5934	30-081	1384	100-024	\$3.70
	<b>B1SB5934</b> Prefilter					
	--	Filter-B1SB1384	--	5934	102-343	\$2.00
	<b>B1SB1388</b> <b>1044627M1</b> Fits Kohler K341, K321, K482, K532, KT17, KT19, MV16 thru 20, M10 thru M20, CV18 thru CV22. Fits Onan models BF, BFA, BG, BGA, B43, B48. For 16 and 18 HP engines. Replaces Kohler 45 083 02; Onan 140-1216.					
	6" OD x 4-5/8" ID x 3" H	Prefilter-B1SB2844	30-093	1388	100-065	\$5.90
	<b>B1SB2844</b> Prefilter. Replaces Kohler 45 083 01; Onan 140-1218.					
	--	Filter-B1SB1388	30-946	2844	100-768	\$2.70

**McCulloch**

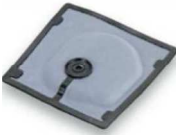
	Dimension	Use With	Oregon	Rotary	Stens	Price
	<b>B1AF19</b> <b>214226, 95213</b> Fits model 600 series 95213, 214226.					
	--	--	55-214	3108	605-238	\$5.30

**McCulloch**

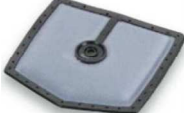





	Dimension	Use With	Oregon	Rotary	Stens	Price
	<b>B1AF20</b> <b>214224, 61460</b> Fits models 110 and 112					
	1-7/8" OD x 7/8" H	--	55-218	3105	605-204	\$3.70
	<b>B1AF23</b> <b>216685, 69922, 92420</b> Fits model 10-10					
	4-1/8" x 4-3/8"	--	55-212	3109	605-246	\$7.60

**Onan**



	Dimension	Use With	Oregon	Rotary	Stens	Price
	<b>B1SB6584</b> <b>140-2331, 140-2535, 140-3111, 140-2588</b> Fits model 125V. For 12.5 and 14 HP engines.					
	4-1/16" L x 2-1/8" W x 3-1/4" H	Prefilter-B1SB7419	30-434	6584	100-061	\$5.60
	<b>B1SB7419</b> <b>140-2335</b> Prefilter					
	--	Filter-B1SB6584	--	7419	100-077	\$2.90
	<b>B1SB2792</b> <b>140-1891, 140-2379</b> Fits 4000 BGE Emerald generator.					
	4" OD x 2-3/4" ID x 3-1/8" H	--	30-432	2792	--	\$6.60
	<b>B1SB1385</b> <b>140-1188</b> Fits 8, 10 and 12 HP horizontal engines.					
	4-3/8" OD x 3" ID x 2-1/4" H	Prefilter-B1SB2780	30-082	1385	100-032	\$4.60
	<b>B1SB2780</b> Prefilter					
	--	Filter-B1SB1385	30-125	2780	102-350	\$2.30
	<b>B1SB6583</b> <b>140-2523, 140-1911, 140-2628-02</b> Fits P216, P218, P220, P224, P260. For 24 HP engines.					
	8" OD x 6-1/2" ID x 3-7/8" H	Prefilter-B1SB7209	30-435	6583	102-319	\$7.30
	<b>B1SB7209</b> <b>140-1912</b> Prefilter					
	--	Filter-B1SB6583	--	7209	102-137	\$4.80
	<b>B1SB6585</b> <b>140-2597, 140-2199</b> Onan generator set equipped with Kubota engines.					
	5-1/8" to 2-3/4" ID x 6-3/4" to 4-1/24" OD x 3" H	Prefilter-B1SB7420	--	6585	--	\$6.10
	<b>B1SB7420</b> <b>140-2255</b> Prefilter					
	--	Filter-B1SB6585	--	7420	--	\$3.60

Replacement Air Filters

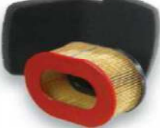
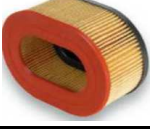

**Onan**

	Dimension	Use With	Oregon	Rotary	Stens	Price
	<b>B1SB1388</b> <b>140-1216</b> Fits Onan models BF, BFA, BG, BGA, B43, B48. For 16 and 18 HP engines.					
	6" OD x 4-5/8" ID x 3" H	Prefilter-B1SB2844	30-093	1388	100-065	\$5.90
	<b>B1SB2844</b> <b>140-1218</b> Prefilter					
	--	Filter-B1SB1388	30-946	2844	100-768	\$2.70
	<b>B1SB2790</b> <b>140-1228, 140-2522, 140-2628</b> Fits models NCH, T260, NHA, NHB, B43, P216, P218, P220, P224. For 16 thru 20 HP engines.					
	8" OD x 6-5/8" ID x 2-1/8" H	Prefilter-B1SB7050	30-430	2790	100-149	\$5.70
	<b>B1SB7050</b> <b>140-1496</b> Prefilter					
	--	Filter-B1SB2790	30-011	7050	100-875	\$2.80
	<b>B1SB2791</b> <b>140-0495</b> Fits model BFA, BGA, CCKA, CCKB, NH, NHB, NHC.					
	4-3/8" OD x 3" ID x 3-1/2" H	--	30-431	2791	--	\$5.00
	<b>B1AF109</b> <b>140P842</b>					
	3-1/4" OD x 1-11/16" ID x 7-1/2" L	--	30-025	8279	100-465	\$21.80

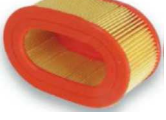





**Partner**

	Dimension	Use With	Oregon	Rotary	Stens	Price
	<b>B11620</b> <b>506 22 42-01, 506 22 63-01, 531 03 14-97</b> Air filter kit for Partner K650 and K700 cut off saws. Includes prefilter.					
	Filter-4-3/4" L x 3-3/8" W x 2-3/32" H. Prefilter 7-7/8" L x 4-1/2" W x 3/4" H	--	30-066	--	100-808, 605-283	\$18.20
	<b>B1AF100</b> <b>506 22 42-01</b> Fits Partner K650 Active.					
	4-3/4" L x 3-3/8" W x 2-3/32" H	Prefilter-B1AF101	--	--	--	\$21.90
	<b>B1AF101</b> <b>506 22 63-01</b> Prefilter					
	7-7/8" L x 4-1/2" W x 3/4" H	Filter-B1AF100	--	--	605-283	\$6.30
	<b>B1AF325</b> <b>506 23 18-01, 506 23 18-02, 506 23 19-01</b> Fits Partner K950 and K1250 cut off saws.					
	6" L x 4-1/2" W x 2-5/8" H	Prefilter-B1AF163	--	--	605-046	\$17.40



**Partner**

	Dimension	Use With	Oregon	Rotary	Stens	Price
	<b>B1AF163</b> 506 23 19-01 Prefilter					
	--	Filter-B1AF325	--	--	605-257	\$6.70
	<b>B1AF262</b> 506 36 72-02, 544 18 16-01, 544 18 16-02 Fits K750 cut-off saws.					
	--	--	--	12887	605-381	\$9.00

**Poulan**

	Dimension	Use With	Oregon	Rotary	Stens	Price
	<b>B1WE7</b> 530-024371 Fits all Poulan XR series 1400, 1500, 1600, 1700, 4000, 5000, 6000 and Pro 150.					
	1-1/4" H x 1-1/4" W x 2-5/8" L	--	55-500	4300	100-297	\$1.70
	<b>B1AF30</b> 24548 Fits models 3400 and 3700					
	3-3/4" x 2-5/8"	--	55-226	3112	605-402	\$7.20
	<b>B1AF32</b> 2586 Fits model 361.					
	1/2" Thick x 4" L x 3-7/16" W	--	55-225	1549	--	\$9.60
	<b>B1AF29</b> 23369, 520-023369 Fits model 25DA.					
	1-1/8" Thick x 3-1/4" L x 1-1/2" W	--	55-223	1568	605-402	\$0.80
	<b>B1AF31</b> 23791, 530-023791 Fits micro 25.					
	1" Thick x 2-5/8" L x 1-1/2" W	--	55-224	1567	605-428	\$0.80
	<b>B1AF255</b> 530-036141 Fits chain saw mills 2200, 2500, 255, 2600, 2750, 2775, 2900, 295, 3050, 310 and 315.					
	--	--	--	12486	--	\$5.70

**Robin**

	Dimension	Use With	Oregon	Rotary	Stens	Price
	<b>B1AF230</b> 220-32812-04, 261-32601-07, 261-32601-17, 277-32606-18, 277-32611-07 Fits EH-18V					
	4-7/8" L x 2-3/8" W x 1-13/16" H	Prefilter-B1AF231	--	9748	100-854	\$9.90
	<b>B1AF231</b> Prefilter					
	--	Filter-B1AF230	--	9904	--	\$1.90

Replacement Air Filters

Robin



	Dimension	Use With	Oregon	Rotary	Stens	Price
 <p><b>B1AF323</b> <b>263-32610-01</b> Fits Robin EH63, EH64, EH65.</p>	5-1/2" ID x 6-7/8" OD x 2-3/8" H	--	--	--	050-821	\$19.80
 <p><b>B1AF324</b> <b>279-32607-07</b></p>	5-3/4" L x 3-5/16" L x 3-7/8" H	--	--	--	--	\$20.70
 <p><b>B1SB7036</b> <b>106-32704-07</b> Fits EC-10, EZ-08 engines.</p>	2-3/8" OD x 1-3/4" ID x 2-1/4" H	--	--	7036	--	\$11.80
 <p><b>B1SB6702</b> <b>206-32601-07</b> Fits model EY18-3W. For 4 &amp; 6 HP horizontal engines. Includes prefilter.</p>	2-1/2" top OD x 3-3/8" bottom OD x 2-3/8" H	--	30-414	6702	102-681	\$12.90
 <p><b>B1SB6704</b> <b>207-32600-08</b> Fits model EY27. For 7.5 HP horizontal engines.</p>	3-1/2" top OD x 4-3/4" bottom OD x 2-1/2" H	--	30-415	6704	102-301	\$12.50
 <p><b>B1SB7038</b> <b>207-32601-08, 207-32606-18</b> Fits EY-27, EY-25, WI-340, WI-390 engines.</p>	2-1/2" top OD x 4-1/4" bottom OD x 3-1/2" H	Prefilter-B1SB7039	30-419	7038	050-009	\$15.70
 <p><b>B1SB7040</b> <b>220-32600-08, 226-32610-07</b> Fits model WI-185. For 4 thru 6 HP vertical shaft engines. Includes prefilter.</p>	2" top OD x 3-13/16" bottom OD x 2-3/8" H	--	30-413	7040	050-029	\$14.10
 <p><b>B1SB6700</b> <b>227-32610-07</b> Fits model W1-185, 4, 6, and 8 HP horizontal engines. Includes Prefilter.</p>	2-1/2" top OD x 4-1/4" OD x 2-1/2" H	--	30-413	6700	102-715	\$12.60
 <p><b>B1WR307</b> <b>227-32803-07, 227-32803-17</b> Fits models W1-145V and W1-185V. For 4 and 5 HP 4-cycle engines. (vertical engines on Snapper)</p>	2-13/16" top OD x 3-9/16" bottom OD x 2-3/8" H	Prefilter-B1SB6695	30-410	6694	102-095	\$8.30
 <p><b>B1AF111</b> <b>234-32604-07</b> For WI-280 engines.</p>	2-1/2" top OD x 4-5/8" bottom OD x 3-3/8" H	--	--	--	--	\$18.60



**Robin**

	Dimension	Use With	Oregon	Rotary	Stens	Price
	<b>B1WR121</b> <b>235-34701-21</b> Fits model W1-450V 12 HP vertical shaft on Snapper rider engines. Includes prefilter.					
	8-7/8" L x 2-3/4" W x 2-5/8" H. 6-1/2" center to center bolt holes.	Prefilter-B1SB6697	30-411	6696	--	\$12.60





**Red Max**

	Dimension	Use With	Oregon	Rotary	Stens	Price
	<b>B1AF99</b> <b>1260-84160</b> Fits model BT17. Minimum order of 5.					
	2-3/4" L x 11-16" W x 3/8" H	--	--	7208	102-210	\$0.35
	<b>B1SB9909</b> <b>T4012-82310</b> Fits model EB7000.					
	7-3/4" L x 5" W x 3/4" H	--	--	--	--	\$12.80

**Ryan**



	Dimension	Use With	Oregon	Rotary	Stens	Price
	<b>B1LB12</b> <b>610312</b> Fits Ryan/Ryobi gas trimmers. Fits models 261, 262, 263, 264, 264-1, 265, 265-T, 274, 275, 275-1, 284, 285, 500, 500-1, 520, 520-1, 540, 540-1, 580, and 580-1					
	2-3/4" L x 1-1/4" W x 1/2" H	--	--	7206	--	\$1.30

**Shindaiwa**





	Dimension	Use With	Oregon	Rotary	Stens	Price
	<b>B1AF247</b> <b>68900-82120</b> Air Filter for Shindaiwa Backpack Blower EB8510.					
	4-7/8" L x 3-3/8" W	--	--	11641	102-949	\$5.10
	<b>B1WE229</b> <b>20000-81701</b> Air Cleaner Assembly used on model GP25.					
	--	Filter-B1SB5864	--	7926	--	\$7.90
	<b>B1SB5864</b> <b>20000-81740</b> Fits Shindaiwa models T25 and T20. Packaged in lots of five.					
	2-3/8" OD x 1/2" H	Air Cleaner Assembly-B1WE229	55-507	5864	100-826	\$1.20
	<b>B1SB8589</b> <b>20036-81740</b> Fits Shindaiwa model T20 trimmers.					
	5/8" ID x 1-1/4" OD x 1" H	Cover-B1SB8519	--	8589	--	\$1.20
	<b>B1SB8519</b> <b>20036-81712</b> Air filter cover fits Shindaiwa T20.					
	--	Filter-B1SB8589	--	8519	--	\$3.70

Replacement Air Filters





**Shindaiwa**

	Dimension	Use With	Oregon	Rotary	Stens	Price
	<b>B1SB8713</b> <b>70064-82210</b> Fits Shindaiwa models T18, F18, T230, C230, LE230, T230XB.					
	3-7/16" L x 13/16" W x 1/2" H	--	55-510	8713	100-392	\$1.20
	<b>B1SB8658</b> <b>20024-81777</b> Cover fits Shindaiwa T27 and C27 trimmer models.					
	--	--	--	8658	--	\$7.50

**Snapper**

	Dimension	Use With	Oregon	Rotary	Stens	Price
	<b>B1AF204</b> <b>5101543</b>					
	4" OD x 2-13/32" ID x 10-1/2" H	Inner Filter-B1AF201	30-055	9583	102-305	\$21.10
	<b>B1AF204B</b> <b>5101543</b> Bulk package of B1AF204 (12).					
	4" OD x 2-13/32" ID x 10-1/2" H	--	30-055	9583	102-305	\$198.00
	<b>B1AF201</b> <b>5101542</b> Inner filter.					
	--	Filter-B1AF204	30-056	9728	100-780	\$21.70
	<b>B1AF201B</b> <b>5101542</b> Bulk package of B1AF201 (12).					
	--	--	30-056	9728	055-165	\$206.40

**Stihl**

	Dimension	Use With	Oregon	Rotary	Stens	Price
	<b>B1AF249</b> <b>4134 141 0300</b> Air filter for Stihl FS120, 200, 250, 350, 450.					
	3-1/4" L x 2-3/4" W	--	--	11659	102-404	\$3.30
	<b>B1AF250</b> <b>4203 141 0301</b> Air Filter for Stihl Backpack Blowers BR420/420C.					
	5-1/8" L x 3-1/2" W x 1-1/4" H	--	--	10963	102-414	\$5.00
	<b>B1AF140</b> <b>4126 124 0801</b> Fits Stihl FS81, FS86, FS106					
	--	--	--	--	--	\$1.00
	<b>B1AF144</b> <b>4130 124 0800</b> Fits Stihl FS36, FS40, FS44.					
	--	--	--	--	--	\$4.90

**Stihl**





	Dimension	Use With	Oregon	Rotary	Stens	Price
	<b>B1AF139</b> <b>4123 124 0801</b> Fits Stihl FS48, FS52, FS56.					
	--	--	--	--	--	\$0.50
	<b>B1AF72</b> <b>4114 124 0800</b> Fits Stihl model FS-50 blower, FS-51, 60, 61, 65.					
	--	--	55-507	6986	100-826	\$0.90
	<b>B1AF53</b> <b>4112 124 0801, 4114 124 0801</b> Fits Stihl FS80. 2" diameter. 5/16"					
	--	--	55-501	7207	100-305	\$3.00
	<b>B1WE229</b> <b>4114 120 1600</b> Air Cleaner Assembly.					
	--	--	--	7926	--	\$7.90
	<b>B1SB8716</b> <b>4133 124 1500</b> Fits Stihl trimmer models FS74, 76, FC72, HS72, 74, 76, BG72, code 135263300.					
	2-7/16" L x 2-7/16" W x 1/4" H	--	--	8716	--	\$1.10
	<b>B1AF46</b> <b>4201 141 0300</b> Use on cut off saws. Canister filter. Fits Cut Quick models TS350, TS510, TS360.					
	3-7/8" OD x 2-3/8" ID x 2-13/16" H	Inner Filter- B1AF44 two bolt, Inner Filter-B1AF45 single bolt, Prefilter-B1AF47	55-240	3116	605-709	\$7.70
	<b>B1AF47</b> <b>4201 141 0310</b> Prefilter. Use on cut off saws models TS350, TS360 and TS510.					
	--	Filter-B1AF46, Inner Filter-B1AF44 two bolt, Inner Filter-B1AF45 single bolt	55-241	5907	605-691	\$8.30
	<b>B1AF44</b> <b>4201 140 1801</b> Use on cut off saws. Fits Cut Quick models TS350, TS510, TS360. Two bolt mount.					
	--	Filter-B1AF46, Prefilter-B1AF47	55-242	5906	605-725	\$6.00
	<b>B1AF45</b> <b>4201 140 1802</b> Use on cut off saws. For Cut Quick models TS350, TS510, TS360. Single bolt mount.					
	--	Filter-B1AF46, Prefilter-B1AF47	--	8283	--	\$5.40
	<b>B1WE7997</b> <b>4203 141 0300</b> For models BR320, BR400 back power blower.					
	2-7/8" OD x 1-3/4" ID x 1-5/8" H	Prefilter-B1AF112	30-416	7997	100-945	\$8.90

Replacement Air Filters

**Stihl**

	Dimension	Use With	Oregon	Rotary	Stens	Price
	<b>B1AF112</b> <b>4203 141 0310</b> For models BR320, BR400 back pack blower.					
	--	Filter-B1WE7997	55-247	--	100-949	\$9.00
	<b>B11622</b> <b>4221 141 0300, 4221 140 1800, 4221 141 0310, 4221 007 1002, 4221 140 440</b> Fits Stihl TS460 cut off saw, TS510 and TS760 with single screw cover. Includes aire filter, prefilter, and wrap.					
	2-1/16" ID x 4-15/32" OD x 2-5/16" H	--	--	--	--	\$20.30
	<b>B1AF332</b> <b>4223 140 1800</b> Fits model TS400. Inner Filter.					
	4-21/32" L x 2-43/64" W x 1-5/32" H	--	--	--	605-741	\$6.20
	<b>B1AF336</b> <b>4223 141 0300</b> Fits Stihl TS400					
	5-5/16" L x 3-1/2" W x 1-15/16" H	Prefilter-B1AF337	--	--	605-228	\$9.80
	<b>B1AF337</b> <b>4223 141 0600</b> Fits Stihl TS400, TS460, TS760.					
	4-7/8" L x 3-5/32" W x 3/4" H	Filter-B1AF336	--	--	605-224	\$6.00
	<b>B11624</b> Fits Stihl TS400. Includes: B1AF332 innder filter, B1AF336 air filter, and B1AF337 prefilter.					
	--	--	--	--	605-208	\$16.20
	<b>B1AF41</b> <b>1118 120 1611</b> Fits model 028.					
	--	--	55-236	5834	605-733	\$25.60
	<b>B1AF57</b> <b>1113 120 1603</b> Fits models 031, 032					
	--	--	55-235	5833	605-683	\$26.20
	<b>B1AF42</b> <b>1119 120 1600, 1119 120 1610, 1119 120 1611, 1119 120 1615</b> Fits Stihl 038.					
	4" L x 3" W x 1-1/8" H	--	--	5837	605-071	\$26.60
	<b>B1AF254</b> <b>4282 141 0300</b> Fits backpack blowers BR500, BR550, BR600.					
	4-1/2" L x 2-1/2" W x 1-1/4" H	--	--	12081	--	\$6.60
	<b>B1AF256</b> <b>1130-124-0800</b> Plate filter. Fits models MS170, MS180.					
	--	--	30-156	11580	--	\$1.60

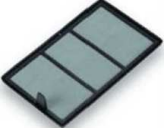



## Stihl

	Dimension	Use With	Oregon	Rotary	Stens	Price
	<b>B1AF263</b> <b>1127 120 1621</b> Fits MS290, MS310, MS390, 029 with IntelliCarb.					
	--	--	--	12305	605-679	\$14.80
	<b>B1AF264</b> <b>1123 120 1613</b> Fits MS10, MS230, MS250, 023 and 025.					
	--	--	--	12306	605-687	\$5.40
	<b>B1AF265</b> <b>4224 141 0300</b> Fits TS700, TS800 Cutquik saws.					
	5-1/2" L x 4-1/16" W x 1-5/8" H	--	--	12561	605-749	\$8.00
	<b>B1AF269</b> <b>4238 140 4401, 4238 141 0300</b> Fits models TS410 and TS420 Cutquik saws.					
	--	Prefilter-B1AF268	30-333	12716	605-555	\$6.60
	<b>B1AF268</b> <b>4238 140 1800, 4238 140 4402</b> Prefilter for B1AF269					
	5-3/4" L x 5-1/2" W x 1-3/4" H	Fiter-B1AF269	--	--	605-559	\$7.90

## Tanaka

	Dimension	Use With	Oregon	Rotary	Stens	Price
	<b>B1WE232</b> <b>00700-911, 410-00731-900</b> Air filter assembly. Fits Tanaka TB373. Replaces Walbro 21-413					
	--	--	--	8080	--	\$9.40

## Tecumseh

	Dimension	Use With	Oregon	Rotary	Stens	Price
	<b>B1SB2775</b> <b>33268</b> Fits models HM70, VM80, HM80, HM100. For 7, 8 & 10 HP engines.					
	4-1/2" L x 2-7/8" W x 2-1/4" H	--	30-100	2775	100-115	\$5.20
	<b>B1SB1386</b> <b>32008</b> Fits models OH120 thru 175, HH100-115, HH80-120 and VH100-149. For 8 thru 16 HP horizontal engines.					
	6" OD x 4-5/8" ID x 1-7/8" H	Prefilter-B1SB1377	30-080	1386	100-040	\$4.40
	<b>B1SB1377</b> <b>32906</b> Prefilter, Replaces Kohler 237421; Tecumseh 32906.					
	--	Filter-B1SB1386	30-941	1377	100-750	\$2.00
	<b>B1SB6515</b> <b>34782, 34782B, 34782A</b> Fits models TVS840, TVXL105 thru 120 and HH60, 70, HS40, HS40, HS50, H50, H70. Used on Snapper V21 and Toro with (4 HP, 2 cycle) Tecumseh engines.					
	2-7/8" OD x 1-1/16" ID x 3-1/2" H, bottom plate hole 1/4"	Prefilter-B1SB6553	30-141	6515	102-285	\$7.20

Replacement Air Filters

Tecumseh

	Dimension	Use With	Oregon	Rotary	Stens	Price
	<b>B1SB6553</b> <b>34783</b> Prefilter. Fits model TVS840.					
	--	Filter-B1SB6515	30-116	6553	102-400	\$1.80
	<b>B1SB8785</b> <b>36745</b> Fits models LEV115 and LEV120. Fits 5.5 HP Centura engines.					
	2-3/4" L x 1-3/4" W x 2-1/8" H	--	30-030	8785	100-317	\$3.40
	<b>B1AF120</b> <b>35850A</b> Fits models OVRM40, OVRM50, TV51 and VLV40 engine. For 4 and 5 HP vertical crankshaft engines.					
	5-1/8" L x 2-11/32" W x 2-3/8" H	--	--	9152	--	\$6.50
	<b>B1SB7732</b> <b>36356</b> Fits models OHV110, OHV115, OHV120, OHV125, OHV130, OHV135, OHV140, OHV 14, OHV145, OHV150, OHV15, OHV155, OHV160, OHV165, OHV17, OHV170 OHV175, YT15H, YT004 and YT005.					
	7-1/8" L x 3-1/8" H x 2-3/4" W wide end / 2" W narrow end	Prefilter-B1SB7746; Nut-B1SB7778	30-024	7732	100-895	\$14.80
	<b>B1SB7746</b> <b>36357</b> Prefilter.					
	--	Filter-B1SB7732	30-952	7746	102-495	\$2.20
	<b>B1SB7778</b> <b>650886</b> Air Filter Nut. Comes with washer and rubber O-Ring attached. 1/4-20 THD. Built in rubber seal.					
	1/4"-20 with "O" Ring	Filter-B1SB7732	--	7778	--	\$0.90
	<b>B1SB1390</b> <b>30727</b> Fits models LAV, VH40 thru 70, HH60 thru 70, HM80, HS40 thru 50. For 3 thru 8 HP and most vertical and horizontal shaft engines. Metal top.					
	3-3/4" OD x 2-3/8" ID x 2" H	--	30-070	1390	100-008	\$3.50
	<b>B105137B</b> <b>36905</b> Bulk package of B105137 (30).					
	2-3/4" L x 1-3/4" W x 2-7/8" H	--	30-031	9200	100-812	\$111.00
	<b>B105137</b> <b>36905</b> Fits models LEV100, LEV115, LEV120, OVRM 105, OVRM65, TVS115, TVS120, RVS115, RVS120. Also fits 4.5, 5 and 5.5 HP engines.					
	2-3/4" L x 1-3/4" W x 2-7/8" H	--	30-031	9200	100-812	\$4.80
	<b>B1SB1395</b> <b>32972</b> Fits models H30, H35, LAV30, LAV35, LAV40, LAV50, ECH90, ECV100, TVS90, TVS105, TVXL105 and ECV series. For Sears Eager 1.					
	2" OD, 3/4" neck OD, 3-7/16" overall length	Prefilter-B1SB6847	30-091	1395	100-180	\$4.20
	<b>B1SB6847</b> <b>35435</b> Prefilter					
	--	Filter-B1SB1395	--	6847	102-160	\$2.30



## Tecumseh



	Dimension	Use With	Oregon	Rotary	Stens	Price
	<b>B1SB2784B</b> <b>35066</b> Bulk package of B1SB2784 (40). Replaces AYP 63087A, 10096.					
	1-3/4" OD x 7/8" ID x 2-7/8" H	--	30-301	2784	100-222	\$84.00
	<b>B1SB2784</b> <b>35066</b> Fits models TVS and ECV series, H30 and H35, LEV115. Sears 1972 and up with plastic canister. 3.5 and 4 HP vertical engines. Replaces AYP 63087A, 10096.					
	1-3/4" OD x 7/8" ID x 2-7/8" H	Prefilter-B1SB6847	30-301	2784	100-222	\$2.60
	<b>B1SB6847</b> <b>35435</b> Prefilter					
	--	Filter-B1SB2784	--	6847	102-160	\$2.30
	<b>B1SB2829</b> <b>35403</b> Fits models TVXL195, TVM195, OVXL120 thru 125, OHV12, OHV13, OHV125 and OHV200. For 8-13 HP vertical engines.					
	8" L x 2" W x 2-5/16" H	Prefilter-B1SB5862	30-111	2829	100-909	\$8.00
	<b>B1SB5862</b> <b>35404</b> Prefilter					
	--	Filter-B1SB2829	30-951	5862	102-111	\$2.90
	<b>B1SB2798</b> <b>35102</b> Fits models TVS105 and TVS90. For Snapper mowers.					
	7-1/16" L x 2" OD x 1" neck OD	Prefilter-B1SB2799	--	2798	100-230	\$5.60
	<b>B1SB2799</b> <b>35103</b> Prefilter. For Tecumseh powered Snappers.					
	--	Filter-B1SB2798	--	2799	--	\$4.00
	<b>B1SB2839</b> <b>429778, 450247</b> Fits 4 HP, 2 cycle engine models TVS840, TVSXL840, TVXL840. Also Fits models TC200-300 engines.					
	3" L x 3" W x 7/8" H	Prefilter-B1SB6846	30-711	2839	100-412	\$4.50
	<b>B1SB8330</b> <b>36046</b> Fits 4, 5.5, and 6 HP engines. Models OHH45, OHH50, VLV126, VLV40, VLV50, VLV55, VLV60, VLV65, VLV66, VLXL50, VLXL55, VL5126.					
	3-7/8" L x 3-7/16" W x 1-1/4" H	--	30-740	8330	100-450	\$5.20
	<b>B1SB5940</b> <b>35500</b> Fits models TVS90, 100, 105 and 120 premier series, TVXL105, TVXL120, OVRM40, 50, OVRM120, and EVC100. For 3.5 thru 5 HP vertical engines.					
	7-3/16" L x 2-3/16" W x 3/4" H	Prefilter-B1SB5955	30-112	5940	100-883	\$5.90
	<b>B1SB5955</b> <b>35705</b> Prefilter.					
	6-1/4" L x 1-1/2" W x 1/2" H	Filter-B1SB5940	30-115	5955	--	\$1.50

Replacement Air Filters









**Tecumseh**

	Dimension	Use With	Oregon	Rotary	Stens	Price
	<b>B1SB2842</b> <b>34340</b> Fits models TVS75, TVS90, TVS105, TVS120 and Excel 105. Fits 3 thru 5 HP engines.					
	5-1/4" L x 1-3/4" W x 1-5/8" H	--	30-117	2842	100-479	\$2.60
	<b>B1SB1392</b> <b>33631</b> Fits (4 HP) V40, VH40, (5 HP) V50, VH50, (6 HP) VH60, (7 HP) VM70, (8 HP) V80, VM80, V60 thru VM100, V70.					
	6" L x 2-1/2" to 3" W x 1-1/2" H	--	30-060	1392	--	\$2.00
	<b>B1SB6848</b> <b>35604</b> Fits models TVS75 and 90.					
	5-3/16" L x 1-9/16" W x 1-1/8" H	--	--	6848	--	\$1.60
	<b>B1SB1382</b> <b>29961</b> Fits (2.2 HP) H22, LAV22, (2.5 HP) H25, LAV25, (3 HP) H30, LAV30, (3.5 HP) H35, LV35, LAV35, (4 HP) HS40, LAV40, (5 HP) LAV50, (9 HP) ECH90, TVS90, TVS105, TVS75, TVXL105, TVS120.					
	2-1/2" to 3-3/8" OD x 2-1/4" H	--	30-083	1382	--	\$1.90
	<b>B1SB1393</b> <b>33006</b> Fits (3.5 HP) TVS90, (4 HP) TVS105, TVXL105, (5 HP) LAV50, TVS75, TVS120, TVS150.					
	2-7/8" L x 2-3/8" W x 1-7/8" H	--	30-084	1393	--	\$1.50
	<b>B1SB1381</b> <b>31700</b> For (3 HP) H22, H25, H30, (3.5 HP) H35, LV35, LAV35, (4 HP) H40, HS40, LAV40, V40, (5 HP) H50, HS50, LAV50, V50, VH50, (6 HP) H60, HH60, V60, VH60, (7 HP) HH70, HM70, V70, VH70, (8 HP) H80, HM80.					
	3-3/4" OD x 2-3/16" H	--	30-205	1381	100-610	\$3.90
	<b>B1SB1383</b> <b>33896</b> Fits models TNT100, TVS100-94040F and TNT120. Also fits Toro Grassmaster.					
	4" L x 2" W x 1-11/16" H	--	--	1383	--	\$2.10
	<b>B1SB2783</b> <b>34910</b> Fits TVM140, 170, 195, 220, VH50 and VH60. For 5 thru 10 HP engines.					
	6-3/8" L x 2-3/4" W x 1-7/8" H	--	30-118	2783	--	\$2.80
	<b>B1SB1384</b> <b>30804</b> Fits Tecumseh H40, H50, H60 and H70 series engines.					
	4-3/8" OD x 3-1/2" ID x 1-1/2" H	Prefilter-B1SB5934	30-081	1384	100-024	\$3.70
	<b>B1SB5934</b> Prefilter					
	--	Filter-B1SB1384	--	5934	102-343	\$2.00
	<b>B1SB1385</b> <b>31925</b> Fits Tecumseh HH80, HH100, HH120, VH80, VH100.					
	4-3/8" OD x 3" ID x 2-1/4" H	Prefilter-B1SB2780	30-082	1385	100-032	\$4.60

**Tecumseh**

	Dimension	Use With	Oregon	Rotary	Stens	Price
	<b>B1SB2780</b> Prefilter					
	--	Filter-B1SB1385	30-125	2780	102-350	\$2.30
	<b>B1AF260</b> <b>37360</b> Fits OV691EA, OV691EP, TVT69 and VTX691.					
	7/1/4" L x 6/7/8" W x 1-1/4" H	--	30-443	11473	102-45	\$7.80

**Toro**



	Dimension	Use With	Oregon	Rotary	Stens	Price
	<b>B1AF204</b> <b>108-9810, 39-9763</b>					
	4" OD x 2-13/32" ID x 10-1/2" H	Inner Filter-B1AF201	30-055	9583	102-305	\$21.10
	<b>B1AF204B</b> <b>108-9810, 39-9763</b> Bulk package of B1AF204 (12).					
	4" OD x 2-13/32" ID x 10-1/2" H	--	30-055	9583	102-305	\$198.00
	<b>B1AF201</b> <b>103-1326</b> Inner filter.					
	--	Filter-B1AF204	30-056	9728	100-780	\$21.70
	<b>B1AF201B</b> <b>103-1326</b> Bulk package of B1AF201 (12).					
	--	--	30-056	9728	055-165	\$206.00
	<b>B1AF244</b> <b>108-3811, 93-2195</b> Fits models BX1500D, BX1800D, BX1830D, BX2200D, BX2230D, BX22D, BX23D.					
	3-1/2" OD x 1-27/32" ID x 7-1/4" H	Inner Filter-B1AF243	--	9550	100-533	\$13.10
	<b>B1AF243</b> <b>98-2982</b> Inner filter for B1AF244					
	--	Outer Filter-B1AF244	--	--	100-541	\$9.20
	<b>B1AF109</b> <b>108-3808, 33-1300</b> For Toro Pro Groundsmaster. Fits Sandpro 12, 14, 2000 and Turf Pro. Primary air filter. Plastic fins.					
	3-1/4" OD x 1-11/16" ID x 7-1/2" L	--	30-025	8279	100-465	\$21.80
	<b>B1AF110</b> <b>108-3833, 27-7110</b> Fits models 62, 2170, 220 and GMT Front Runner GM 72, 322D, 327. For 62" and 72" Groundmaster, Groundmaster 3000 and Reelmaster. Primary air filter. Plastic fins.					
	4-1/8" OD x 10-3/8" L	--	30-026	8328	100-519	\$25.90
	<b>B1AF232</b> <b>98018</b> Fits models SV470S, SV480, SV530S, SV540S, SV590S, SV600S, and SV610 Courage single series for 15 thru 17 HP engines.					
	8" L x 7-3/4" W x 1-1/2" H	--	--	11466	--	\$12.90

Replacement Air Filters



**Toro**

	Dimension	Use With	Oregon	Rotary	Stens	Price
 <p><b>B1SB6991</b>  <b>63-9380</b> Used on 2-cycle Suzuki-equipped Toro mowers. For 1988 and newer models.</p>	6-9/16" L x 3-3/8" W x 1-5/8" H	--	30-422	6991	100-564	\$6.00
 <p><b>B1EC24</b>  <b>47-6320</b> For backpack blowers. Use with heavy duty filter kit. Fits Echo PB400E and Toro 40cc blowers                      Also fits John Deere models 4 and 4E.</p>	1-3/4" ID x 3-1/4" OD x 7" L	--	30-143	8585	100-576	\$12.10
 <p><b>B1AF90</b>  <b>46-3960</b> 2-7/16" Diameter. Fits most trimmers such as Echo, Poulan, and Toro using Kioritz engines.</p>	2-7/16" Diameter	--	55-506	6966	100-404	\$3.20
 <p><b>B1AF54</b>  <b>54-5190</b> Fits Tanaka TC1000, 2000, 3000, and 4000 trimmers.</p>	2-3/8" OD x 3/8" H	--	55-505	7679	100-396	\$1.70
 <p><b>B1SB2843</b>  <b>81-4120</b> For 4 cycle OHV Suzuki engines.</p>	7" L x 2" W x 1-1/4" H	--	30-421	2843	100-263	\$3.30
 <p><b>B1AF215</b>  <b>9809212</b> Fits models 123602, 123607, 123672. Fits Intek Pro 5, 5.5, 6, 6.5 HP</p>	3-3/4" L x 2-3/8" W x 3-1/8" H	Prefilter-B1AF179	30-039	9591	100-871	\$8.60
 <p><b>B1AF179</b>                      Prefilter</p>	--	Filter-B1AF215	--	9592	102-091	\$1.70
 <p><b>B1SB2790</b>  <b>UN10774</b> Fits models NHC, T260, NHA, NHB, B43, P216, P218, P220, P224. For 16 thru 20 HP engines. Replaces Onan 140-1228, 140-2522, 140-2628</p>	8" OD x 6-5/8" ID x 2-1/8" H	Prefilter-B1SB7050	30-430	2790	100-149	\$5.70
 <p><b>B1SB7050</b>                      Prefilter. Replaces Onan 140-1496</p>	--	Filter-B1SB2790	30-011	7050	100-875	\$2.80
 <p><b>B1SB6585</b>  <b>92-0956</b> Fits 16 and 20 HP engines.</p>	5-1/8" to 2-3/4" ID x 6-3/4" to 4-1/24" OD x 3" H	Prefilter-B1SB7420	--	6585	--	\$6.10
 <p><b>B1SB7420</b>                      Prefilter</p>	--	Filter-B1SB6585	--	7420	--	\$3.60

## Toro

	Dimension	Use With	Oregon	Rotary	Stens	Price
	<b>B1SB2782</b> <b>81-0100</b> For 2-cycle Suzuki engine.					
	6-3/4" L x 3-5/8" W x 1-1/4" H	--	30-954	2782	--	\$2.00
	<b>B1AF209</b> <b>98019</b> Fits LX500, GT2100, GT2200 and GT2300 tractors. Includes Prefilter. Replaces Kohler 32 083 03-S.					
	5-5/8" L x 4-3/8" W x 1-3/4" H	Prefilter-B1SB7043	--	11505	100-774	\$12.40
	<b>B1SB7043</b> Prefilter					
	--	Filter-B1AF209	--	7043	100-432	\$1.90



## Walker

	Dimension	Use With	Oregon	Rotary	Stens	Price
	<b>B1AF244</b> <b>5090-01</b> Primary air filter. Replaces Kohler 25 083 02 S.					
	3-1/2" OD x 1-27/32" ID x 7-1/4" H	Inner Filter-B1AF243	--	9550, 11842	100-533	\$13.10
	<b>B1AF243</b> <b>5090-3</b> Inner filter. Fits Engineaire and Kohler CH22-66557, TH16-52527. Replaces Kohler 25 083 03 S					
	--	Filter-B1AF244	--	--	100-541	\$9.20

## Weedeater



	Dimension	Use With	Oregon	Rotary	Stens	Price
	<b>B1WE7</b> <b>530-024371</b> Fits all Poulan XR series 1400, 1500, 1600, 1700, 4000, 5000, 6000 and Pro 150.					
	1-1/4" H x 1-1/4" W x 2-5/8" L	--	55-500	4300	100-297	\$1.70

## Wheel Horse

	Dimension	Use With	Oregon	Rotary	Stens	Price
	<b>B1SB2790</b> <b>NN10774</b> Fits models NHC, T260, NHA, NHB, B43, P216, P218, P220, P224. For 16 thru 20 HP engines. Replaces Onan 140-1228, 140-2522, 140-2628					
	8" OD x 6-5/8" ID x 2-1/8" H	Prefilter-B1SB7050	30-430	2790	100-149	\$5.70
	<b>B1SB7050</b> <b>NN10176</b> Prefilter. Replaces Onan 140-1496					
	--	Filter-B1SB2790	30-011	7050	100-875	\$2.80
	<b>B1SB6584</b> <b>NN10872</b> Fits model 125V. For 12.5 and 14 HP engines. Replaces Onan 140-2331, 140-2535, 140-3111, 140-2588.					
	4-1/16" L x 2-1/8" W x 3-1/4" H	Prefilter-B1SB7419	30-434	6584	100-061	\$5.60

Replacement Air Filters

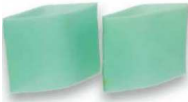
**Wheel Horse**

	Dimension	Use With	Oregon	Rotary	Stens	Price
	<b>B1SB7419</b> <b>NN10898</b> Prefilter. Replaces Onan 140-2335.					
	--	Filter-B1SB6584	--	7419	100-077	\$2.90
	<b>B1AF280</b> <b>KW10071</b> Fits models FB460. For 12.5 HP engines. Replaces Kawasaki 11013-2021.					
	7" L x 2-1/4" W x 2-3/4" H	--	30-303	6567	100-347	\$9.90

**Wisconsin**

	Dimension	Use With	Oregon	Rotary	Stens	Price
	<b>B1SB1386</b> <b>L0194A</b> Fits models K241, K301, K321. For 10, 12, 14 HP engines. Replaces Kohler 235116.					
	6" OD x 4-5/8" ID x 1-7/8" H	Prefilter-B1SB1377	30-080	1386	100-040	\$4.40
	<b>B1SB1377</b> prefilter. Replaces Kohler 237421; Tecumseh 32906					
	--	Filter-B1SB1386	--	--	--	\$2.00
	<b>B1SB7036</b> <b>106-32704-07</b> Fits EC-10, EZ-08 engines.					
	2-3/8" OD x 1-3/4" ID x 2-1/4" H	--	--	7036	--	\$11.80
	<b>B1SB6700</b> <b>EY2273261007</b> Fits models W1-185, 4, 6, and 8 HP horizontal engines. Includes prefilter.					
	2-1/2" top OD x 4-1/4" bottom OD x 2-1/2" H	--	30-413	6700	102-715	\$12.60
	<b>B1SB6704</b> <b>EY2073260008</b> Fits model EY27. For 7.5 HP horizontal engines.					
	3-1/2" top OD x 4-3/4" bottom OD x 2-1/2" H	--	30-415	6704	102-301	\$12.50
	<b>B1SB7038</b> <b>EY2073260618, EY207326018</b> Fits EY-27, EY-25, WI-340, WI-390 engines.					
	2-1/2" top OD x 4-1/4" bottom OD x 3-1/2" H	Prefilter-B1SB7039	30-419	7038	050-009	\$15.70
	<b>B1SB7039</b> Prefilter					
	--	Filter-B1SB7038	--	7039	--	\$3.70
	<b>B1WR307</b> <b>EY2273280307, EY2273280317</b> Fits models W1-145V and W1-185V. For 4 and 5 HP 4-cycle engines (vertical engines on Snapper).					
	2-13/16" top OD x 3-9/16" bottom OD x 2-3/8" H	Prefilter-B1SB6695	30-410	6694	102-095	\$8.30





## Wisconsin





	Dimension	Use With	Oregon	Rotary	Stens	Price
	<b>B1SB6695</b> <b>EY2273261308</b> Prefilter					
	--	Filter-B1WR307	--	6695	--	\$1.90
	<b>B1WR121</b> <b>EY2353470121</b> Fits model W1-450V 12 HP vertical shaft on Snapper rider engines. Includes prefilter.					
	8-7/8" L x 2-3/4" W x 2-5/8" H. 6-1/2" center to center bolt holes	Prefilter-B1SB6697	30-411	6696	--	\$12.60
	<b>B1SB6697</b> <b>EY2353261008</b> Prefilter					
	--	Filter-B1WR121	30-500	6697	--	\$1.70
	<b>B1SB6702</b> <b>EY2063260107</b> Fits model EY18-3W. For 4 & 6 HP horizontal engines. Includes prefilter.					
	2-1/2" top OD x 3-3/8" bottom OD x 2-3/8" H	--	30-414	6702	102-681	\$12.90
	<b>B1AF102</b> <b>L0188</b> Fits Wisconsin model TH, THD and TJD. For 17 and 20 HP engines.					
	4-1/4" OD x 2" ID x 6-1/4" H	--	30-102	8332	100-069	\$7.90
	<b>B1SB2781</b> <b>L0173B</b>					
	3-7/16" OD x 2-1/16" ID x 4-3/16" H	--	--	2781	--	\$14.00
	<b>B1SB7040</b> <b>EY2203260008, EY2263261007</b> Fits model W1-185. For 4 thru 6 HP vertical shaft engines. Includes prefilter.					
	2" top OD x 3-13/16" bottom OD x 2-3/8" H	--	30-413	7040	050-029	\$14.10
	<b>B1SB2785</b> <b>L0175E</b>					
	4-1/4" OD x 2" ID x 4" H	--	--	2785	--	\$9.60
	<b>B1SB7164</b> <b>2273600203</b> Standard duty air filter. Fits models W1-145 and W1-185					
	4-5/8" L x 3-1/4" W x 1-3/16" H	--	--	7164	--	\$2.70
	<b>B1AF111</b> <b>EY2343260407</b> For W1-280 engines.					
	2-1/2" top OD x 4-5/8" bottom OD x 3-3/8" H	--	--	--	--	\$18.60
	<b>B1SB7165</b> <b>EY2063600303</b> Standard duty air filter. Fits models EY25W and EY27W.					
	5-1/2" L x 3-11/16" W x 1-3/8" H	--	--	7165	--	\$3.60

Replacement Air Filters

**Woods**

	Dimension	Use With	Oregon	Rotary	Stens	Price
 <p><b>B1SB2777 - 70301</b> Fits models 290000, 290400, 290700, 294000, 294400, 294700, 303400, 303700, 303900, 392642, 394018, 400400 thru 422400, 350700, 350400, 351400. For L-Head Twin Horizontal and all vertical V-Twin OHV Vanguard Engines. Replaces Briggs &amp; Stratton 392642, 394018.</p>	7" OD x 5-5/8" ID x 2-1/8" H	Prefilter-B1SB2797	30-101	2777	100-131	\$5.40
	<p><b>B1SB2797</b> <b>70302</b> Prefilter. Replaces Briggs &amp; Stratton 271271, 272490.</p>					
 <p><b>B1AF109</b> <b>70649</b></p>	3-1/4" OD x 1-11/16" ID x 7-1/2" L	--	30-025	8279	100-465	\$21.80
	<p><b>B1SB1389</b> <b>71803</b> Fits models K241, K301, K321 and K361. 10 thru 20 HP engines. Replaces Kohler 47 083 03.</p>					
	7" OD x 5-5/8" ID x 2-1/2" H	--	30-095	1389	100-016	\$5.00

**Yanmar**

	Dimension	Use With	Oregon	Rotary	Stens	Price
 <p><b>B1AF110</b> <b>121420-12511, 12464-12510</b></p>	4-1/8" OD x 10-3/8" L	--	30-026	8328	100-519	\$25.90
	<p><b>B1AF204</b> <b>119808-12520</b></p>					
	4" OD x 2-13/32" ID x 10-1/2" H	Inner Filter-B1AF201	30-055	9583	102-305	\$21.10
	<p><b>B1AF204B</b> <b>119808-12520</b> Bulk package of B1AF204 (12).</p>					
	4" OD x 2-13/32" ID x 10-1/2" H	--	30-055	9583	102-305	\$198.00
	<p><b>B1AF201</b> Inner filter.</p>					
	--	Filter-B1AF204	30-056	9728	100-780	\$21.70
	<p><b>B1AF201B</b> Bulk package of B1AF201 (12).</p>					
	--	--	30-056	9728	055-165	\$206.40



Product No.	OEM Manufacturer	Application	Oregon	Rotary	Stens	Price
<b>B1SB6000B</b>	Briggs & Stratton: 298090; John Deere: PT4265; Scag: 48057-02; Toro: 42-5240	Bulk package with 50 of our B1SB6000 fuel filter	69-052	6000	120-188	\$69.00
<b>B1SB1349B</b>	Briggs & Stratton: 394358; John Deere: AM38708; Toro: 56-6360	Bulk package with 50 of our B1SB1349 fuel filter	69-051	1349	120-014	\$105.00
<b>B1SB7998B</b>	Briggs & Stratton: 493629, 691035; Bobcat: 38666; Kohler: 25 050 02; John Deere: AM108356	Bulk package with 40 of our B1SB7998 fuel filters.	07-107	7998	120-158	\$110.00
<b>B1FF202B</b>	Husqvarna: 503 44 32-01, 501-87-76-01	Bulk package with 100 of our B1FF202 fuel filters.	07-213	9227	610-220	\$290.00
<b>B1SB1358B</b>	Ariens: 21541500; Bobcat: 38283, 38666; Buntton: PM244; Club Car: 1013684, 1014522, 102003201; Craftsman: 24688; Cub Cadet: OCC-25 050 22; Exmark: 1-303197, 303197, 1-109585, 109585; EZ-GO: 72084G01; Grasshopper: 101001; Gravely: 21410800, 21541500; Jacobsen: 552265; John Deere: AM116304; Kohler: 25 050 03, 25 050 08, 25 050 22; Kubota: E7187-82150; Lesco: 050311; Onan: 149-2206-01; Toro: 71-5960, 98021; Yamaha: JN3-F4560-00, JN6-F4560-00	Bulk package with 40 of our B1SB1358 fuel filters.	69-054	1358	120-436	\$98.00
<b>B1FF100B</b>	John Deere: AM116304; Toro: 71-5960; Onan: 149-2206-01	Bulk package with 20 of our B1FF100 fuel filters.	07-160, 07-103, 07-107	1358	120-436	\$51.00
<b>B1WE4B</b>	McCulloch: 216985; Homelite: 49422	Bulk package with 100 of our B1WE4 fuel filters.	07-200	4995	610-089, 610-701, 610-087	\$172.00

**Ariens**

	Part Name	OEM No.	Oregon	Rotary	Stens	Price
	<b>B1SB1358</b>	Two step filter. Fits 1/4" ID and 5/16" ID fuel line. Exact OEM replacement.				
	In Line Fuel Filter	21541500	69-054	1358	120-436	\$3.50

Fuel Filters

**Ariens**

	Part Name	OEM No.	Oregon	Rotary	Stens	Price
<b>B1SB1358B</b> Bulk package with 40 of our B1SB1358 fuel filters.						
In Line Fuel Filters		21541500	69-054	1358	120-436	\$120.00

**Bobcat**

	Part Name	OEM No.	Oregon	Rotary	Stens	Price
<b>B1SB7998</b> Fits select engines with fuel pumps. Fits 1/4" ID fuel line. 80 micron. Order in multiples of 10.						
In Line Fuel Filter		38283, 38666	07-107	7998	120-158	\$3.80
<b>B1SB7998B</b> Bulk package with 40 of our B1SB7998 fuel filters.						
In Line Fuel Filters		38283, 38666	07-107	7998	120-158	\$136.00



**Bolens**

	Part Name	OEM No.	Oregon	Rotary	Stens	Price
<b>B1SB1357</b> Fits 1/4" ID fuel line. Order in multiples of 10.						
In Line Fuel Filter		1727491	69-053	1357	120-006	\$2.20

**Briggs & Stratton**

	Part Name	OEM No.	Oregon	Rotary	Stens	Price
<b>B1SB6000</b> For engine without fuel pumps. Fits 1/4" ID fuel line. Red. Order in multiples of 10.						
In Fuel Line Filter		298090	69-052	6000	120-188	\$2.00
<b>B1SB6000B</b> Bulk package with 50 of our B1SB6000 fuel filters.						
In Line Fuel Filters		298090	69-052	6000	120-188	\$69.00
<b>B1SB1349</b> For engines with fuel pumps. Fits 1/4" ID fuel line. White. Order in multiples of 10.						
In Line Fuel Filter		394358	69-051	1349	120-014	\$2.90
<b>B1SB1349B</b> Bulk package with 50 of our B1SB1349 fuel filters.						
In Line Fuel Filters		394358	69-051	1349	120-014	\$92.00
<b>B1FF300</b> 10 micron. Universal metal style. Fits 5/16" ID fuel line.						
In Line Fuel Filter		492836	07-112, 07-104	9146	120-410	\$5.40



**Briggs & Stratton**

	Part Name	OEM No.	Oregon	Rotary	Stens	Price
	<b>B1SB7998</b> Fits select engines with fuel pumps. Fits 1/4" ID fuel line. 80 micron. Order in multiples of 10.					
	In Line Fuel Filter	493629, 691035	07-107	7998	120-158	\$3.70
	<b>B1SB7998B</b> Bulk package with 40 of our B1SB7998 fuel filters.					
	In Line Fuel Filters	493629, 691035	07-107	7998	120-158	\$102.00



**Bunton**

	Part Name	OEM No.	Oregon	Rotary	Stens	Price
	<b>B1FF300</b> 10 micron. Universal metal style. Fits 5/16" ID fuel line.					
	In Line Fuel Filter	PM244	07-112, 07-104	9146	120-410	\$5.40



**Club Car**

	Part Name	OEM No.	Oregon	Rotary	Stens	Price
	<b>B1SB1358</b> Two step filter. Fits 1/4" ID and 5/16" ID fuel line. Exact OEM replacement.					
	In Line Fuel Filter	1013684-1014522, 102003201	69-054	1358	120-436	\$3.70
	<b>B1SB1358B</b> Bulk package with 40 of our B1SB1358 fuel filters.					
	In Line Fuel Filters	1013684, 1014522, 102003201	69-054	1358	120-436	\$124.00

**Craftsman**



	Part Name	OEM No.	Oregon	Rotary	Stens	Price
	<b>B1SB1358</b> Two step filter. Fits 1/4" ID and 5/16" ID fuel line. Exact OEM replacement.					
	In Line Fuel Filter	24688	69-054	1358	120-436	\$3.70
	<b>B1SB1358B</b> Bulk package with 40 of our B1SB1358 fuel filters.					
	In Line Fuel Filters	24688	69-054	1358	120-436	\$136.00

**Echo**



	Part Name	OEM No.	Oregon	Rotary	Stens	Price
	<b>B1SB3903</b> High grade felt. Fits 3/16" ID fuel line. Order in multiples of 10.					
	In Tank Fuel Filters	131205-06530	07-206	3903, 13903	610-014	\$2.10
	<b>B1FF182</b> Filter only. High grade felt. For use with our B1SB3903 filter assembly. Order in multiples of 10.					
	Replacement Fuel Filter	--	07-201	1400	610-071	\$2.30

Fuel Filters





**Exmark**

	Part Name	OEM No.	Oregon	Rotary	Stens	Price
	<b>B1FF300</b> 10 micron. Universal metal style. Fits 5/16" ID fuel line.					
	In Line Fuel Filter	303197	07-112, 07-104	9146	120-410	\$5.40
	<b>B1SB1358</b> Two step filter. Fits 1/4" ID and 5/16" ID fuel line. Exact OEM replacement.					
	In Line Fuel Filter	1-109585, 1-303197, 109585, 303197	69-054	1358	120-436	\$3.70
	<b>B1SB1358B</b> Bulk package with 40 of our B1SB1358 fuel filters.					
	In Line Fuel Filters	1-109585, 1-303197, 109585- 303197	69-054	1358	120-436	\$136.00

**EZ-GO**



	Part Name	OEM No.	Oregon	Rotary	Stens	Price
	<b>B1SB1358</b> Two step filter. Fits 1/4" ID and 5/16" ID fuel line. Exact OEM replacement.					
	In Line Fuel Filter	72084G01	69-054	1358	120-436	\$3.70
	<b>B1SB1358B</b> Bulk package with 40 of our B1SB1358 fuel filters.					
	In Line Fuel Filters	72084G01	69-054	1358	120-436	\$136.00

**Grasshopper**







	Part Name	OEM No.	Oregon	Rotary	Stens	Price
	<b>B1CO107</b> Fits larger HP models. 10 micron. Fits 5/16" ID fuel line.					
	In Line Fuel Filter	101005	07-104	9146	120-678	\$5.90
	<b>B1SB1358</b> Two steps filter. Fits 1/4" ID and 5/16" ID fuel line. Exact OEM replacement.					
	In Line Fuel Filter	101001	69054	1358	120-436	\$3.70
	<b>B1SB1358B</b> Bulk package with 40 of our B1SB1358 fuel filters.					
	In Line Fuel Filters	101001	69-054	1358	120-436	\$136.00
	<b>B1FF300</b> 10 micron. Universal metal style. Fits 5/16" ID fuel line					
	In Line Fuel Filter	101005	07-112, 07-104	9146	120-410	\$5.40



## Gravelly

	Part Name	OEM No.	Oregon	Rotary	Stens	Price
	<b>B1SB1358</b> Two step filter. Fits 1/4" ID and 5/16" ID fuel line. Exact OEM replacement.					
	In Line Fuel Filter	21410800, 21541500	69-054	1358	120-436	\$3.70
	<b>B1SB1358B</b> Bulk package with 40 of our B1SB1358 fuel filters					
	In Line Fuel Filters	21410800, 21541500	69-054	1358	120-436	\$136.00

## Homelite



	Part Name	OEM No.	Oregon	Rotary	Stens	Price
	<b>B1WE4</b> Fits 1/8" ID fuel line. For all mini saws and trimmers. .50" OD x 1.25" L. Order in multiples of 10.					
	In Tank Fuel Filter	49422	07-200	4995	610-089, 610-701, 610-087	\$2.10
	<b>B1WE4B</b> Bulk package with 100 of our B1WE4 fuel filters.					
	In Tank Fuel Filter	49422	07-200	4995	610-089, 610-701, 610-087	\$152.00
	<b>B1FF298</b> Residue-free porous plastic. Fits 3/16" ID fuel line. Order in multiples of 5.					
	In Tank Fuel Filter	64083	07-215	3905	610-063	\$1.60
	<b>B1FF299</b> Filter only. Residue-free porous plastic. 40-50 micron. For use with our B1FF298 fuel filter assembly. Order in multiples of 10.					
	Replacement Fuel Filter	64083	07-216	3906	610-071	\$1.00
	<b>B1SB3903</b> High grade felt. Fits 3/16" ID fuel line. Order in multiples of 10.					
	In Tank Fuel Filter	69923	07-206	3903, 13903	610-014	\$2.10
	<b>B1FF182</b> Filter only. High grade felt. For use with our B1SB3903 filter assembly. Order in multiples of 10.					
	Replacement Fuel Filter	64083	07-201	1400	610-071	\$2.20
	<b>B1SB3902</b> High grade felt. Fits 3/16" ID fuel line. Order in multiples of 10.					
	In Tank Fuel Filter	--	07-207	3902	610-006	\$2.40
	<b>B1FF172</b> Filter only. High grade felt. For use with our B1SB3902 fuel filter assembly. Order in multiples of 10.					
	Replacement Fuel Filter	59253-1A	07-202	1399	610-030	\$2.10

Fuel Filters



**Honda**

	Part Name	OEM No.	Oregon	Rotary	Stens	Price
<b>B112165</b> Fits Honda GX110, GX120, GX140, GX160, GX200, GX240, GX270, GX340 and GX390. Use with our B112150, B112155, B112160 fuel tanks.						
In Tank Fuel Filter		17672-880-000, 0474759	--	--	120-414	\$7.50





**Husqvarna**

	Part Name	OEM No.	Oregon	Rotary	Stens	Price
<b>B1FF202</b> Residue free porous plastic. Double wall design. 30 micron. Fits 3/16" ID fuel line. Order in multiples of 10						
In Tank Fuel Filter		503 44 32-01, 501-87-76-01	07-213	9227	610-220	\$3.80
	<b>B1FF202B</b> Bulk package with 100 of our B1FF202 fuel filters					
In Tank Fuel Filters		503 44 32-01, 501-87-76-01	07-213	9227	610-220	\$290.00











**Jacobsen**

	Part Name	OEM No.	Oregon	Rotary	Stens	Price
<b>B1SB1358</b> Two step filter. Fits 1/4" ID and 5/16" ID fuel line. Exact OEM replacement.						
In Line Fuel Filter		552265	69-054	1358	120-436	\$3.70
	<b>B1SB1358B</b> Bulk package with 40 of our B1SB1358 fuel filters.					
In Line Fuel Filters		552265	69-054	1358	120-436	\$136.00

**John Deere**



	Part Name	OEM No.	Oregon	Rotary	Stens	Price
<b>B1SB1357</b> Fits John Deere riding mowers 66, 68, RX73, RX75, SX75 and LX173; Front mount F510. Fits 1/4" ID fuel line. Order in multiples of 10.						
In Line Fuel Filters		AM107314, AM36483	69-053	1357	120-006	\$2.10
	<b>B1SB7998</b> Fits select engines with fuel pumps. Fits 1/4" ID fuel line. 80 micron. Order in multiples of 10.					
In Line Fuel Filter		AM108356	07-107	7998	120-158	\$3.70
	<b>B1SB7998B</b> Bulk package with 40 of our B1SB7998 fuel filters.					
In Line Fuel Filters		AM108356	07-107	7998	120-158	\$115.00
	<b>B1FF100</b> Two step filter/ Fits 1/4" ID and 5/16" ID fuel line. 70 micron. Manufactured for use with Ethanol. Larger in size than our B1SB1358 fuel filter.					
In Line Fuel Filter		AM116304	07-160, 07-103, 07-107	12619	120-436	\$3.30

John Deere





	Part Name	OEM No.	Oregon	Rotary	Stens	Price
	<b>B1FF100B</b> Bulk package with 20 of our B1FF100 fuel filters					
	In Line Fuel Filter	AM116304	07-160, 07-103, 07-107	1358	120-436	\$50.00
	<b>B1SB1358</b> Two step filter Fits 1/4" ID and 5/16" ID fuel line. Exact OEM replacement.					
	In Line Fuel Filter	AM116304	69-054	1358	120-436	\$3.30
	<b>B1SB1358B</b> Bulk package with 40 of our B1SB1358 fuel filters.					
	In Line Fuel Filters	AM116304	69-054	1358	120-436	\$136.00
	<b>B1SB1349</b> For engines with fuel pumps. Fits 1/4" ID fuel line. White. Order in multiples of 10.					
	In Line Fuel Filter	AM38708	69-051	1349	120-014	\$2.90
	<b>B1SB1349B</b> Bulk package with 50 of our B1SB1349 fuel filters.					
	In Line Fuel Filters	AM38708	69-051	1349	120-014	\$115.00
	<b>B1CO107</b> Fits John Deere front mount mowers F912 and F932. Fits larger HP models. 10 micron. Fits 5/16" ID fuel line.					
	In Line Fuel Filter	AM76035	07-104	9146	120-678	\$5.90
	<b>B1SB6000</b> For engines without fuel pumps. Fits 1/4" ID fuel line. Red. Order in multiples of 10.					
	In Line Fuel Filter	PT4265	69-052	6000	120-188	\$2.00
	<b>B1SB6000B</b> Bulk package with 50 of our B1SB6000 fuel filters.					
	In Line Fuel Filters	PT4265	69-052	6000	120-188	\$70.00
	<b>B1VPD6132</b> Fits X740, X744, X748, X749, X495, front mowers, gators, fairway/greens mowers, compact utility tractors, and skid-steer loaders with diesel engines.					
	Fuel Filter	M801101	--	--	--	\$5.40
	<b>B1VPD6144</b> Fits some compact utility tractors, excavators, fairway mowers, wide area mowers, and skid-steer loaders with diesel engines.					
	Fuel Filter	T111383	--	--	--	\$5.80

Fuel Filters



**Jonsered**

	Part Name	OEM No.	Oregon	Rotary	Stens	Price
	<b>B1FF202</b> Residue free porous plastic. Double wall design. 30 micron. Fits 3/16" ID fuel line. Order in multiples of 10					
	In Tank Fuel Filter	--	07-213	9227	610-220	\$3.80
	<b>B1FF202B</b> Bulk package with 100 of our B1FF202 fuel filters.					
	In Tank Fuel Filters	--	07-213	9227	610-220	\$275.00







**Kohler**

	Part Name	OEM No.	Oregon	Rotary	Stens	Price
	<b>B1FF300</b> 10 micron. Universal metal style. Fits 5/16" ID fuel line.					
	In Line Fuel Filter	25 050 03	07-112, 07-104	9146	120-410	\$5.40
	<b>B1SB7998</b> Fits select engines with fuel pumps. Fits 1/4" ID fuel line. 80 micron. Order in multiples of 10.					
	In Line Fuel Filter	25 050 02	07-107	7998	120-158	\$3.70
	<b>B1SB7998B</b> Bulk package with 40 of our B1SB7998 fuel filters.					
	In Line Fuel Filters	25 050 02	07-107	7998	120-158	\$72.10
	<b>B1SB1358</b> Two step filter. Fits 1/4" ID and 5/16" ID fuel line. Exact OEM replacement.					
	In Line Fuel Filter	25 050 03, 25 050 08, 25 050 2	69-054	1358	120-436	\$3.30
	<b>B1SB1358B</b> Bulk package with 40 of our B1SB1358 fuel filters.					
	In Line Fuel Filter	25 050 03, 25 050 08, 25 050 2	69-054	1358	120-436	\$136.00



**Kubota**

	Part Name	OEM No.	Oregon	Rotary	Stens	Price
	<b>B1VPD6903</b> Fits Kubota B6000, B6000E, BX1500D, BX1800D, BX1830D, BX22D, BX23D, BX2200D, BX2200E, and BX2230D. Fits 5/16" ID fuel filters.					
	In Line Fuel Filter	12581-43012	07-104	9146	120-678	\$5.80
	<b>B1CO107</b> Fits larger HP models. 10 micron. Fits 5/16" ID fuel line.					
	In Line Fuel Filter	13351-4301-0, 12581-43012	07-704	9146	120-678	\$5.90
	<b>B1SB1358</b> Two step filter. Fits 1/4" ID and 5/16" ID fuel line. Exact OEM replacement.					
	In Line Fuel Filter	E7187-82150	69-054	1358	120-436	\$3.30

**Kubota**

	Part Name	OEM No.	Oregon	Rotary	Stens	Price
	<b>B1SB1358B</b> Bulk package with 40 of our B1SB1358 fuel filters.					
	In Line Fuel Filters	E7187-82150	69-054	1358	120-436	\$136.00
	<b>B1VPD6051</b> - Fits Kubota L175, L185DT, L185F, L225, L225DT from SN 1001, L245DT, L245F, L245H, L285P, L285WP, L295DT, L295F, L305DT, L305F, L345, L345DT, L2050DT from SN>10104, L2050F from SN> 10001, L2350DT, L2350F, L2500F, L2600DT, L2950DTWET, L2950F, L3000DT, and L3000F.					
	Fuel Filter	15221-43170	--	--	--	\$10.30
	<b>B1VPD6072</b> - Fits Kubota B20, B21, B1550D, B1550HSTD, B1550HSTE, B1700D, B1700E, B1700HD, B1700HSD, B1700HSE, B1750D, B1750E, B1750HSTD, B1750HSTE, B2100D, B2100E, B2100HD, B2100HSD, B2100HSE, B2150D, B2150E, B2150HSD, B2150HSE, B2150HSTD, B2400D, B2400E, B2400HD, B2400HSD, B2400HSE, B2710HSD up to Sn 15496, B4200D, B5100DP, B5100E, B5100EP, B5200D, B5200E, B6000, B6000E, B6100D, B6100DP, B6100E, B6100EP, B6100HSTD, B6100HSTE, B6200D, B6200DU, B6200E, B6200HSTD, B6200HSTE, B7100D, B7100HSTD, B7100HSTE, B7200DU, B7200E, B7200HSTD, B7200HSTE, B7300HSD, B8200, B8200DP, B8200EP, B8200HSTD, B8200HSTEP, B8200HSTDU, B9200DCDP, B9200DCEP, B9200HSDTOW, B9200HSTD, and B9200HSTEP.					
	Fuel Filter	15231-43560	--	--	120-670	\$9.90
	<b>B1VPD6132</b> Fits most Kubota L series models.					
	Fuel Filter	15521-43160	--	--	--	\$5.40
	<b>B1VPD6144</b> Fits Kubota ST25, ST30, ST30 ALPHA, STV32, ST35, ST35 ALPHA, STV36, and STV40.					
	Fuel Filter	16271-43560	--	--	--	\$5.80
	<b>B1VPD6152</b> - Fits Kubota B1410, B1610, B1710D, B2110D, B2110HDB, B2410D, 2410HDB, B2410HSD, B2410HSDB, B2410HSE, B2710HSD from SN 50101, B2710HDB, B7400HSD, B7410D, B7500D, B7522D TN, B7500HSD, B7510D, B7510DN, B7510HSD, B7610HSD, B7800HSD, L2800F, L3400DT and L3400F.					
	Fuel Filter	6A320-59930	--	--	--	\$12.40

**Lesco**



	Part Name	OEM No.	Oregon	Rotary	Stens	Price
	<b>B1SB1358</b> Two step filter. Fits 1/4" ID and 5/16" ID fuel line. Exact OEM replacement.					
	In Line Fuel Filter	50311	69-054	1358	120-436	\$3.30
	<b>B1SB1358B</b> Bulk package with 40 of our B1SB1358 fuel filters.					
	In Line Fuel Filters	50311	69-054	1358	120-436	\$136.00

**McCulloch**







	Part Name	OEM No.	Oregon	Rotary	Stens	Price
	<b>B1FF174</b> Filter only. High grade felt. Order in multiples of 10					
	Replacement Fuel Filter	63932	07-204	1391	610-048	\$1.00

Fuel Filters

**McCulloch**

	Part Name	OEM No.	Oregon	Rotary	Stens	Price
	<b>B1WE4</b> Fits 1/8" ID fuel line. For all mini saws and trimmers. .50" OD x 1.25" L. Order in multiples of 10.					
	In Tank Fuel Filter	216985	07-200	4995	310-089, 610-701, 610-087	\$2.10
	<b>B1WE4B</b> Bulk package with 100 of our B1WE4 fuel filters.					
	In Tank Fuel Filters	216985	07-200	4995	610-089, 610-701, 610-087	\$151.00

**Onan**







	Part Name	OEM No.	Oregon	Rotary	Stens	Price
	<b>B1FF100</b> Two step filter. Fits 1/4" ID and 5/16" ID fuel line. 70 micron. Manufactured for use with Ethanol. Larger in size than our B1SB1358 fuel filter.					
	In Line Fuel Filter	149-2206-01	07-160, 07-103, 07-107	12619	120-436	\$3.30
	<b>B1FF100B</b> Bulk package with 20 of our B1FF100 fuel filters.					
	In Line Fuel Filter	149-2206-01	07-160, 07-103, 07-107	1358	120-436	\$54.00
	<b>B1SB1358</b> Two step filter. Fits 1/4" ID and 5/16" ID fuel line. Exact OEM replacement.					
	In Line Fuel Filter	149-2206-01	69-054	1358	120-436	\$3.30
	<b>B1SB1358B</b> Bulk package with 40 of our B1SB1358 fuel filters.					
	In Line Fuel Filters	149-2206-01	69-054	1358	120-436	\$136.00
	<b>B1SB6000</b> For engines without fuel pumps. Fits 1/4" ID fuel line. Red. Order in multiples of 10.					
	In Line Fuel Filter	149-2356	69-052	6000	120-188	\$2.00
	<b>B1SB6000B</b> Bulk package with 50 of our B1SB6000 fuel filters.					
	In Line Fuel Filters	149-2356	69-052	6000	120-188	\$70.00

**Poulan**



	Part Name	OEM No.	Oregon	Rotary	Stens	Price
	<b>B1FF298</b> Residue-free porous plastic. Fits 3/16" ID fuel line. Order in multiples of 5.					
	In Tank Fuel Filter	23364	07-215	3905	610-063	\$1.60



## Poulan

	Part Name	OEM No.	Oregon	Rotary	Stens	Price
	<b>B1FF299</b> Filter only. Residue-free porous plastic. 40-50 micron. For use with our B1FF298 fuel filter assembly. Order in multiples of 10.					
	Replacement Fuel Filter	23364	07-216	3906	310-071	\$1.00
	<b>B1SB3903</b> High grade felt. Fits 3/16" ID fuel line. Order in multiples of 10.					
	In Tank Fuel Filter	91481	07-206	3903, 13903	610-014	\$2.10
	<b>B1FF182</b> Filter only. High grade felt. For use with our B1SB3903 filter assembly. Order in multiples of 10.					
	Replacement Fuel Filter	23364	07-201	1400	610-071	\$2.20
	<b>B1FF202</b> Residue free porous plastic. Double wall design. 30 micron. Fits 3/16" ID fuel line. Order in multiples of 10.					
	In Tank Fuel Filter	--	07-213	9227	610-220	\$3.80
	<b>B1FF202B</b> Bulk package with 100 of our B1FF202 fuel filters.					
	In Tank Fuel Filters	--	07-213	9227	610-220	\$270.00
	<b>B1SB3902</b> High grade felt. Fits 3/16" ID fuel line. Order in multiples of 10.					
	In Tank Fuel Filter	--	07-207	3902	610-006	\$2.40
	<b>B1FF172</b> Filter only. High grade felt. For use with our B1SB3902 fuel filter assembly. Order in multiples of 10.					
	Replacement Fuel Filter	34032	07-202	1399	610-030	\$2.10

## Scag

	Part Name	OEM No.	Oregon	Rotary	Stens	Price
	<b>B1SB6000</b> For engines without fuel pumps. Fits 1/4" ID fuel line. Red. Order in multiples of 10.					
	In Line Fuel Filter	48057-02	69-052	6000	120-188	\$2.00
	<b>B1SB6000B</b> Bulk package with 50 of our B1SB6000 fuel filters.					
	In Line Fuel Filters	48057-02	69-052	6000	120-188	\$72.00

## Shindaiwa



	Part Name	OEM No.	Oregon	Rotary	Stens	Price
	<b>B1SB8529</b> Fits Shindaiwa T25, T27, C35, and B45.					
	Fuel Filter with Weight	22100-85411	--	8529	--	\$5.40

Fuel Filters



**Snapper**

	Part Name	OEM No.	Oregon	Rotary	Stens	Price
	<b>B1SB1357</b> Fits 1/4" ID fuel line. Order in multiples of 10.					
	In Line Fuel Filter	1-4359, 1-7777	69-053	1357	120-006	\$2.10





**Stihl**

	Part Name	OEM No.	Oregon	Rotary	Stens	Price
	<b>B1FF173</b> Filter only. Foam. Order in multiples of 10.					
	Replacement Fuel Filter	1110 358 1800	07-205	3904	610-055	\$1.00
	<b>B1FF203</b> Fits Stihl TS08 and TS50. Fits 1/4" ID fuel line.					
	In Tank Fuel Filter	1111 350 3503, 0000 350 3500	07-211	7298	610-170	\$8.00



**Tecumseh**

	Part Name	OEM No.	Oregon	Rotary	Stens	Price
	<b>B1WE4</b> Fits 1/8" ID fuel line. For all mini saws and trimmers. .50" OD x 1.25" L. Order in multiples of 10.					
	In Tank Fuel Filter	410263	07-200	4995	610-089, 610-701, 610-087	\$2.10
	<b>B1WE4B</b> Bulk package with 100 of our B1WE4 fuel filters.					
	In Tank Fuel Filters	410263	07-200	4995	610-089, 610-701, 610-087	\$151.00









**Tillotson**

	Part Name	OEM No.	Oregon	Rotary	Stens	Price
	<b>B1SB3902</b> High grade felt. Fits 3/16" ID fuel line. Order in multiples of 10.					
	In Tank Fuel Filter	OW-497	07-207	3902	610-006	\$2.40
	<b>B1FF172</b> Filter only. High grade felt. For use with our B1SB3902 fuel filter assembly. Order in multiples of 10.					
	Replacement Fuel Filter	95-172	07-202	1399	610-030	\$2.10
	<b>B1FF298</b> Residue-free porous plastic. Fits 3/16" ID fuel line. Order in multiples of 5.					
	In Tank Fuel Filter	OW-802	07-215	3905	610-063	\$1.60
	<b>B1FF299</b> Filter only. Residue-free porous plastic. 40-50 micron. For use with our B1FF298 fuel filter assembly. Order in multiples of 10.					
	Replacement Fuel Filter	95-182	07-216	3906	610-071	\$1.00

**Tillotson**





	Part Name	OEM No.	Oregon	Rotary	Stens	Price
	<b>B1SB3903</b> High grade felt. Fits 3/16" ID fuel line. Order in multiples of 10.					
	In Tank Fuel Filter	OW-802	07-206	3903, 13903	610-014	\$2.10
	<b>B1FF182</b> High grade felt. For use with our B1SB3903 filter assembly. Order in multiples of 10.					
	Replacement Fuel Filter	95-182	07-201	1400	610-071	\$2.20

**Toro**





	Part Name	OEM No.	Oregon	Rotary	Stens	Price
	<b>B1C0107</b> Fits larger HP models. 10 micron. Fits 5/16" ID fuel line.					
	In Line Fuel Filter	18/1520	07-104	9146	120-678	\$5.90
	<b>B1FF300</b> - Fits Toro Greensmaster 3, 300 and 3000, Parksmaster, Turf Pro HTM, Groundsmaster 52, 62, 117, 217-D, 225, 228, 72, 322-D, 325-D and 327 with 72" decks; and Z Master Z256 and Z286 with Kohler engines. 10 micron. Universal metal style. Fits 5/16" ID fuel line.					
	In Line Fuel Filter	18-1520, 108-3831, 99-9403	07-112, 07-104	9146	120-410	\$5.40
	<b>B1SB3903</b> High grade felt. Fits 3/16" ID fuel line. Order in multiples of 10.					
	In Tank Fuel Filter	34-7260	07-206	3903, 13903	610-014	\$2.10
	<b>B1FF182</b> Filter only. High grade felt. For use with our B1SB3903 filter assembly. Order in multiples of 10.					
	Replacement Fuel Filter	--	07-201	1400	610-071	\$2.20
	<b>B1SB6000</b> For engines without fuel pumps. Fits 1/4" ID fuel line. Red. Order in multiples of 10.					
	In Line Fuel Filter	42-5240	69-052	6000	120-188	\$2.00
	<b>B1SB6000B</b> Bulk package with 50 of our B1SB6000 fuel filters.					
	In Line Fuel Filters	42-5240	69-052	6000	120-188	\$90.00
	<b>B1SB1349</b> For engines with fuel pumps. Fits 1/4" ID fuel line. White. Order in multiples of 10.					
	In Line Fuel Filter	56-6360	69-051	1349	120-014	\$2.90
	<b>B1SB1349B</b> Bulk package with 50 of our B1SB1349 fuel filters.					
	In Line Fuel Filters	56-6360	69-051	1349	120-014	\$102.00

Fuel Filters



**Toro**

	Part Name	OEM No.	Oregon	Rotary	Stens	Price
	<b>B1FF100</b> Two step filter. Fits 1/4" ID and 5/16" ID fuel line. 70 micron. Manufactured for use with Ethanol. Larger in size than our B1SB1358 fuel filter.					
	In Line Fuel Filter	71-5960	07-160, 07-103, 07-107	12619	120-436	\$3.20
	<b>B1FF100B</b> Bulk package with 20 of our B1FF100 fuel filters.					
	In Line Fuel Filters	71-5960	07-160, 07-103, 07-107	1358	120-436	\$50.00
	<b>B1SB1358</b> Two step filter. Fits 1/4" ID and 5/16" ID fuel line. Exact OEM replacement.					
	In Line Fuel Filter	71-5960, 98021	69-054	1358	120-436	\$3.40
	<b>B1SB1358B</b> Bulk package with 40 of our B1SB1358 fuel filters.					
	In Line Fuel Filters	71-5960, 98021	69-054	1358	120-436	\$136.00



**Walbro**

	Part Name	OEM No.	Oregon	Rotary	Stens	Price
	<b>B1W125527</b> OEM Walbro. Felt filter. Fits 3/16" ID fuel line, up to 30 cc.					
	In Tank Fuel Filter	125-527-1	007-214	--	615-093, 610-393	\$2.40
	<b>B1W125527D</b> OEM Walbro. Display pack includes 10 Walbro 125-527-1 fuel filters.					
	In Tank Fuel Filter	125-527D	07-124	9024	610-125	\$28.60
	<b>B1W125528</b> OEM Walbro. Felt filter. Fits 3/16" ID fuel line.					
	In Tank Fuel Filter	125-528-1	07-219	9025	610-101, 610-717	\$4.00
	<b>B1W125528D</b> OEM Walbro. Display pack includes 10 Walbro 125-528-1 fuel filters.					
	In Tank Fuel Filters	125-528D	07-219	--	610-129	\$44.00
	<b>B1W125532</b> OEM Walbro. Felt filter. Fits 3/16" ID fuel line, 30 cc to 125 cc.					
	In Tank Fuel Filter	125-532-1	--	--	615-910	\$3.10





**Walbro**

	Part Name	OEM No.	Oregon	Rotary	Stens	Price
	<b>B1W125532D</b> OEM Walbro. Display pack includes 10 Walbro 125-532-1 fuel filters.					
	In Tank Fuel Filters	125-532D	--	--	--	\$45.00
	<b>B1W125535</b> OEM Walbro. Felt filters. Fits 3/16" ID fuel line.					
	In Tank Fuel Filter	125-535-1	--	--	615-912	\$3.90
	<b>B1W125552</b> OEM Walbro. Non-replaceable filter. Fits 3/16" ID fuel line.					
	In Tank Fuel Filter	125-552-1	--	--	615-913	\$2.40



**Yamaha**

	Part Name	OEM No.	Oregon	Rotary	Stens	Price
	<b>B1SB1358</b> Two step filter. Fits 1/4" ID and 5/16" ID fuel line. Exact OEM replacement.					
	In Line Fuel Filter	JN3-F4560-00, JN6-F4560-00	69-054	1358	120-436	\$3.30
	<b>B1SB1358B</b> Bulk package with 40 of our B1SB1358 fuel filters.					
	In Line Fuel Filters	JN3-F4560-00, JN6-F4560-00	69-054	1358	120-436	\$136.00

**Zama**

	Part Name	OEM No.	Oregon	Rotary	Stens	Price
	<b>B1WE4</b> Fits 1/8" ID fuel line. For all mini saws and trimmers. .50" OD x 1.25" L. Order in multiples of 10.					
	In Tank Fuel Filter	ZF-1	07-200	4995	610-089, 610-701, 610-087	\$2.10
	<b>B1WE4B</b> Bulk package with 100 of our B1WE4 fuel filters.					
	In Tank Fuel Filters	ZF-1	07-200	4995	610-089, 610-701, 610-087	\$151.00
	<b>B1WE115</b> Fits 3/16" ID fuel line. For engines 30 cc or smaller. .514" OD x 1.227" L. Order in multiples of 10.					
	In Tank Fuel Filter	ZF-2	07-208	9137	610-174	\$1.60
	<b>B1WE116</b> Fits 1/8" ID fuel line. For engines 30 cc or larger. .712" OD x 1.647 L. Order in multiples of 10.					
	In Tank Fuel Filter	ZF-3	07-209	9138	610-178	\$3.10

Fuel Filters

Zama	Part Name	OEM No.	Oregon	Rotary	Stens	Price
	<b>B1WE117</b>	Fits 3/16" ID fuel line. For engine 30 cc or larger. .717" OD x 1.622" L. Order in multiples of 10.				
	In Tank Fuel Filter	ZF-4	07-210	9139	610-182	\$3.10
	<b>B1WE118</b>	Fits 1/4" ID fuel line. For engines 30 cc or larger. .712" OD x .1.638" L. Order in multiples of 10.				
	In Tank Fuel Filter	ZF-5	07-211	9140	610-186	\$3.10



**IF YOU CAN'T FIND WHAT YOU ARE LOOKING**

**FOR..... PLEASE CALL OUR TOLL FREE**

**PHONE NUMBER 1-800-989-0162**

**WE WILL BE HAPPY TO ASSIST YOU!!**







### 4-Cycle Engine Oil

Sunbelt 4-cycle engine oil is a high-detergent oil specially designed for small air cooled four-cycle engines. It provides superior oxidation, anti-wear, bearing corrosion, and deposit control while meeting warranty requirements for Briggs & Stratton, Tecumseh and other small engine manufacturers.

Product No.	Size	Case Qty	Price
<b>B1AC47</b>	20 oz.	12	\$3.70
<b>B1AC50</b>	48 oz.	6	\$6.90



**SAE 10W-30 Multi-Weight Oil**

1 qt./Case quantity: 12  
**B1AC402** \$6.50



**Oil Seal**

Dipstick seal for engines with extended plastic dipstick. Screws into engine base. OD: .936" Replaces B&S 281370, 281370S, 68838.

**B1BR26** \$2.00



**Oil Drain Valve**

Mounts permanently to Briggs & Stratton and Kohler engines with 3/8" NPTF drain plugs. Comes with drainage hose and instructions.

**B1AC1959** \$9.00



**Magnetic Oil Plug**

3/8"-18 NPTF thread. Replaces B&S 92738, 690289 and Kohler X-305-4, X-305-4-S.

**B1AC14** \$4.50



**Oil Plug**

Fits most small engines. Nylon. Replaces B&S 66768, 281658, 281658S and Tecumseh 27625.

**B1SB2681** \$0.90



**Oil Dipstick**

Fits GX160 engines. Replaces Honda 17230-ZE1-820.

**B1HD0025** \$4.90



**Oil Drain Valve**

Mounts permanently to engine. Connect any 1/2" hose when draining oil. 3/8"-18 NPTF thread. Replaces Kohler 25 462 08, 25 755 14, 25 755 14-S.

**B1AC52** \$9.60



**Plastic Drain Pan**





Oil-resistant, all purpose plastic pan with built in, raised rim handles. 12" diameter, 4" deep. 6 quart capacity.

**B1PG77** \$16.50

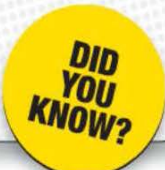

**You can download new product bulletins, view current promotions, and check pricing all online? Visit our website to begin. If you don't have your login information, call us and customer service will be happy to help!**



	Relief Pressure	Anti-Drain	Thread Size	OD	Height	Micron	Oregon	Rotary	Stens	Price
 <p><b>B1OF286 Oil Filter</b></p> <p><b>Ariens: 08200204, 21397200; Cub Cadet: 12-050-08; Ferris: 5021144X1; Gravely: 21397200; Husqvarna: 531 30 73-93; Hustler: 747303; John Deere: KH1205008, AM101207, GY20577; Kohler: 12 050 01, 12 05 08; Lesco: 032009; Toro: 98020; Woods: 70820.</b></p> <p>Fits Kohler CH10-20, CV18-20. John Deere lawn tractors SST15, L100 and LX173 with Kohler engines as well as Briggs &amp; Stratton models 260700, 261700, 290700. Cub Cadet 1500 and 200 series lawn tractors with Kohler engines.</p>	10-20 PSI	Yes	3/4"-16	2.96"	2.66"	20	83-284	7916	120-523	\$6.40
	 <p><b>B1OF285 Oil Filter</b></p> <p><b>Bad Boy: 063-2004-00; Briggs &amp; Stratton: 4154, 492056, 492932, 492056, 5049, 5076, 696854, 842921; Grasshopper: 100803; Husqvarna: 531 30 70-43, 531 30 73-89; John Deere: AM125424, GY20577, LG492932S; Kawasaki: 49065-7002, 49065-7007; Tecumseh: 36262, 36563, 36961</b></p> <p>Briggs &amp; Stratton small version filter for 12-25 HP Vanguard engines, pressure lubrication engines. Fits models 104700, 261700, 303700, 290700, 294700 and 350700. Tecumseh OHV 115-170, TVT691, OV and VTX. Kawasaki 15-19 HP FB460V, FC420V, FC540V, FD501D and FD590V. Kohler CH18-25, CV18-25.</p>	10-20 PSI	Yes	3/4"-16	2.96"	2.26"	30	83-013	6929	120-485
 <p><b>B1OF280 Oil Filter</b></p> <p><b>Bad Boy: 063-2010-00, 063-5400-00; Bobcat: 6513601, 6652366; Briggs &amp; Stratton: 491056, 4153; Case: C26191; Cub Cadet: 2505025; Grasshopper: 100802; Gravely: 042366; Husqvarna: 531 30 73-92; Jacobsen: 5000440; John Deere: AM101207; Kohler: 52 050 02 S; Onan: 122-0645; Toro: NN10147, 491056; Woods: 70939</b></p> <p>Fits Briggs &amp; Stratton Vanguard pressure lubrication models 260700, 261700 and 290700. Fits Kohler KT and Magnum engines. Kohler models KT17-19 series II, M18-20, MV16-20, CH11-25, CV11-22 Pro Series, K582. Onan models P216, 218, 220, BFA, BGA, BGAL, BGD, BGD, BGE, BGEL, BGM, B43G and B48GM. Fits Bobcat skid steer models 632, 642, 732; 440B, 450 with Kohler engines and 722 with Ford engine. John Deere STX46 lawn tractor. Toro and Woods with Kohler engines.</p>		10-20 PSI	Yes	3/4"-16	2.96"	3.40"	20	83-283	5909	120-345
	 <p><b>B1OF243 Oil Filter</b></p> <p><b>Bad Boy: 063-2090-00; Club Car: 41016-67, 1016467; Cub Cadet: 490-201-0001; Cushman: 833438; EZ-GO: 607454; Ferris: 5021334X1; Generac: 070185, 70185, 070185D, 070185GS, 70185GS; Grasshopper: 100806; Gravely: 21527900, 043594, 21480600, 20777000, 21535800; Husqvarna: 531 30 73-88, Hustler: 772079; John Deere: AM101054, AM107423; Kawasaki: 49065-2057, 49065-2070, 49065-2071, 49065-2074, 49065-2078, 49065-2062; Kees: 363312; Lesco: 014888; Onan: 122-0737, 122-0737-03; Robin: 248-65801-00, 261-65902-A0; Shindaiwa: 5023396X1; Snapper: 7-7355, 7077288, 77288; Toro: NN10684, 108-3842, KW10586, KW10761; Woods: 72859.</b></p> <p>Fits most Kawasaki engines including 14-19 HP models FH381-721V, FH601-770D, FJ180V and FX751-1000V. Onan 12-1/2, 14 and 17 HP engines; model E125V. Cub Cadet 1500 series with 15-19 HP Kawasaki engines. John Deere 112L, LX172 and LX176 with Kawasaki engines and front mount F510. Robin models EH18V, EH64 and EH65. Tecumseh OHV15 specs 204003, 204005, 204010, 204013 and OHV16 spec 204205A. Snapper, Toro and Woods with Kawasaki engines.</p>	11-17 PSI	Yes	3/4"-16	2.67"	2.90"	20	83-282	6600	120-634







Oil and Transmission Filters



	Relief Pressure	Anti-Drain	Thread Size	OD	Height	Micron	Oregon	Rotary	Stens	Price
<b>B1FF181 Oil Filter</b>  <b>Bobcat I.R: 3974113B, Grasshopper: 100800; Honda: 15410-MJO-405, 15410-MJO-004, 15410-MBO-000, 15400-679-023, 15400-679-033, 15400-POH-305; Howard Prince: 05364; Hustler: 785634; Jacobsen: 554011, 557759; John Deere: AM101378, AM100750, M806418, M806419; Kubota: 70000-15241, 16271-32090, 15841-32430, 70000-74034, HH150-32094; Napa: 7-07113; Toro: 42-9030; Troy Bilt: 1874139; Yanmar: 129150-35150.</b> Fits Honda EM5000 and Honda water cooled engines. John Deere 300, 400, F912, 925, 932, 935 series. Howard Price 1260 with Yanmar engines. Kubota T1600H, D600, D650, D722E, D722-EB, D750, D750B, D850, D950. Troy Bilt latest YHRs, Sunstrand transmissions. Bobcat excavator models 56, 76, X220, X320, 443B, 453 and 463; skid steer models 553, 443, 543, and 543B. John Deere 300, F912, 915, 925, 932 and 935 series.										
	11-14 PSI	Yes	M20 x 1.5	3-1/8"	3"	25	83-301	6681	120-360	\$9.40
<b>B1SB6676 Oil Filter</b>  <b>Bobcat: 6512143, 6647672; John Deere: AM 34770, AM39687; Kohler: 277233; Lesco: 012367; Onan: 122-0445, 122-0800, 122-0469; Toro: 277233</b> N52M, P224 and T260. Also fits some Bobcat skid steers.										
	8-12 PSI	Yes	3/4"-16	3"	4-3/16"	25	83-028	6676	120-626	\$12.00
<b>B1VPD5136 Oil Filter</b>  <b>Kubota: 15213-32090</b> Fits Kubota models L175, L210, L225, L185F, L245F, L245H, L295F, L305F, L185DT, L225DT, L245DT, L295DT and L305DT.										
	29 PSI	Yes	3/4" - 16	2.99"	4.80"	20	--	--	--	\$13.10
<b>B1VPD5101 Oil Filter</b> <b>Grasshopper: 100800; Kubota: 15241-32090</b>  Fits Kubota models B20, B21, B1550D, B1550HSTD, B1550HSTE, B1700D, B1700E< B1700HD, B1700HSD, B1700HSE, B1710D, B1750D, B1750E, B1750HSTD, B1750HSTE, B2100D, B2100E, B2100HD, B2100HSD, B2100HSE, B2110D, B2110HDB, B2150D, B2150E, B2150HSD, B2150HSE, B2150HSTD. B2400D, B2400E, B2400HD, B2400HSD, B2400HSE, B2410D, B2410HDB, B2410HSDB, B2410HSE, B4200D, B5200D, B5200E, B6100D, B6100DP, B6100E, B6100EP, B6100HSTD, B6100HSTE, B5100DP, B5100E, B5100EP, B6200D, B6200DU, B6200E, B6200HSTD, B6200HSTE, B7100D, B7100DP, B7100HSTD, B7100HSTE, B7500D, B7200DU, B7200HSTD, B7200HSTE, B7500DTN, B7500HSD, B7510D, B7510DN, B7510HSD, B7610HSD, B8200, B8200DP, B8200EP, B8200HSTD, B8200HSTD, B8200HSTEP, B9200DCDP, B9200DCEP, B9200HSDTOW, B9200HSTD, B9200HSTEP, BX22D, BX23D, BX1800D, BX1830D, BX2200D and BX2200E.										
	7.98 PSI	Yes	M20 x 1.5-6H INT	3.31"	3.19"	30	--	12120	--	\$9.80
<b>B1VPD5103 Oil Filter</b>  <b>Kubota: 15402-32430</b> Fits Kubota models L285P, L285WP, L3750, L3750DT, L4150, L4150DT, L4150DTU and L4150U.										
	35.53 PSI	Yes	3/4" -16 LINE-2B	3.7"	4.16"	30	--	--	--	\$16.40
<b>B1VPD5135 Oil Filter</b>  <b>Kubota: 15521-32430</b> Fits Kubota models L235, L275, L2050F, L2250F, L2550F, L2850F, L3250F, L355SS, L2050DT, L2250DT, L2550DT, L2850DT, L3250DT, L3350DT, L2550TOW, L2550DTGST and L2850DTGST.										
	10-20 PSI	Yes	3/4" - 16	3.66"	3.7"	40	--	--	--	\$7.70

	Relief Pressure	Anti-Drain	Thread Size	OD	Height	Micron	Oregon	Rotary	Stens	Price
 <p><b>B1VPD5105 Oil Filter</b>  <b>Honda: 15410-MCJ-003; Kubota: 15853-32430</b>                      Fits Kubota models B1410, B1610, B7200E, B7410D, BX1500D, BX2230D, B7300HSD and B7400HSD; Honda GXV530 16 HP V-Twin.</p>	11-17 PSI	--	M20 x1.5	2.68"	2.56"	20	--	10883	--	\$9.80
 <p><b>B1VPD5107 Oil Filter</b>  <b>Kubota: 16271-32092</b>                      Fits Kubota models B2410HSD, ST25, ST30, B2710HDB, B2710HSD, and B7800HSD.</p>	14.5 PSI	Yes	M20 x 1.5	3.19"	3.98"	20	--	--	--	\$7.00
 <p><b>B1VPD5108 Oil Filter</b>  <b>Kubota: 17321-32430</b>                      Fits most Kubota L series models; ST30 ALPHA, STV32, STV36 and STV40.</p>	12.47 PSI	Yes	3/4" - 16 UNF-2B	3.68"	3.4"	30	--	--	--	\$10.20
 <p><b>B1VPK5603 Oil Filter</b>  <b>Kubota: 32701-37950</b>                      Fits Kubota B series - B20, B2150HSD, B8200 and B9200.</p>	--	--	1-1/8" - 16	3.69"	5.37"	10	--	--	--	\$14.80
 <p><b>B1VOK5602 Hydraulic Filter</b>  <b>Honda: 15400-679-023, 15410-MJ0-004, 15410-ZJ4-999AH, 15400-PR3-004; John Deere: AM101378; Kubota: 30401-37580</b>                      GX360K1 engines, tractor models 3813, 4514; John Deere models F22100, F22400.</p>	--	--	--	--	--	--	83-301	6681	--	\$11.20
 <p><b>B1VPK5611 Hydraulic Filter</b>  <b>Kubota: 31391-38830</b>                      Fits Kubota L series - L2250DT, L2250F, L2550DT, L2550F, L2600F, L2650DT, L2650DTWET, L2650F, L2800DT,</p>	--	--	--	--	--	--	--	--	--	\$19.90
 <p><b>B1VPK5612 Hydraulic Filter</b>  <b>Kubota: 67955-37710</b>                      Fits Kubota B series models B1410, B1610, B1700D, B1700E, B2100D, B2100E, B2400D, B2400E, B7410D, B7500D, B2410HSD, B7400HSD, B7500HSD, B2410HSDB.</p>	290 PSI	--	M20 x 1.5	3.23"	4.53"	100 wire mesh	--	--	--	\$9.50
 <p><b>B1VPK5500 Hydraulic Filter</b>  <b>Kubota: 38430-37710</b>                      Fits Kubota models L235, L275, L2250F, L2550F, L2850F, L3250F, L2250DT, L2550DT, L2850DT, L3250DT, B9200DCDP, B9200DCEP, L2550DTGST and L2850DTGST,</p>	--	--	--	--	--	--	--	--	--	\$16.80
 <p><b>B1VPK5604 Hydraulic Filter</b>  <b>Kubota: 66021-36060</b>                      Fits most Kubota B series models.</p>	--	--	--	--	--	--	--	--	--	\$11.80



Oil and Transmission Filters

	Relief Pressure	Anti-Drain	Thread Size	OD	Height	Micron	Oregon	Rotary	Stens	Price
 <p><b>B1VPK5600 Hydraulic Filter</b>  <b>Kubota: K2561-36990</b>                      Fits Kubota models BX22D, BX23D, BX1500D, BX1800D, BX1830D, BX2200D and BX2230D.</p>	--	--	--	--	--	--	--	--	--	\$10.70
 <p><b>B1VPK5614 Hydraulic Filter</b>  <b>Kubota: TAO40-37710</b>                      Fits most Kubota L series models.</p>	--	--	--	--	--	--	--	--	--	\$24.60
 <p><b>B1HP600 Transmission Filter</b>  <b>HG521114; Toro: 109-3321</b>                      Original Hydro-Gear filter. Fits Hydro-Gear Transmission models ZT-2800, 3100, 3400, G700.</p>	--	No	3/4" - 16	2.60"	2.93"	25 nom 40 abs	--	12374	120-738	\$12.90
 <p><b>B1HP601 Transmission Filter</b>  <b>AYP: 142912, 182642; Hustler: 768341; Hydro-Gear: 51563</b>                      Original Hydro-Gear filter. Fits Hydro-gear 210-3000.</p>	--	No	3/4" - 16	3"	3.36"	25 nom 40 abs	--	--	--	\$12.70
 <p><b>B1WH35 Transmission Filter</b>  <b>Ariens: 03192800; Bobcat: 48045B; Bolens: 1726450; Cub Cadet: 395789-R-2, 723-3014, 759-3014, 759-3605, 923-3014; Gravely: 39306, John Deere: AM35176, AM39653; MTD: 727-0162; Onan: 122-0185; Simplicity: 171439, 1650954; Toro: 79-5270, 106-5830, 108335</b>                      Fits most Ariens, Howard, Onan and Simplicity Hydro models. Bobcat XW Hydro series and 700 series. Cub Cadet 1250, 1450 and 1862. Gravely Pro Master 400. Fits MTD Hydro Unit. John Deere lawn tractors 140, 230, 300, 312, 314, 316, 317, 318, 322, 330, 332, 400, 420, 430 and 900 series; front mount mower F911, F912, F915, F925, F932 and F935; Z-Trak mowers F620, F680, F687, F737 and F757; also fits some John Deere loaders. Toro 300, 400 and 500 hydro series. Troy Bilt 1455, 1476, 1477, 166, 1660, 1666, 1886, 194, 197, 198, 2086, 2087 and QT-16.</p>	--	No	3/4" - 16	3-1/2"	3-3/4"	16	83-300	6680	120-265	\$11.10
 <p><b>B1OF211 Transmission Filter</b>  <b>Bobcat: 2188179; Bunton: PL7488; Dixie Chopper: 60105, 68140; Dixon: 5565, 7252, 539125960; Encore: 423063, 423361; Exmark: 1-513211, 1-633750, 109-4180; Ferris: 22028, 5022028; Honda: 25641-VE4-003; Husqvarna: 531 30 73-94, 539 10 26-06; Kees: 102606, 101164; Toro: 23-9740, 1-633750, E-633750</b>                      Fits Bunton ZT200. Dixon 501, 502, 5501, 5017, 5020, 5023, 5421 and 5601. Exmark Hydro units, Viking, Explorer, Lazer Z, Turf Tracer, Turf Ranger. Honda HRC7013, HRC7018 and HRC7020. Also fits Dixie Chopper.</p>	18-22 PSI	Yes	3/4"-16	3"	3-1/2"	10	83-010	--	120-380	\$9.30
 <p><b>B1SB8631 Transmission Filter</b>  <b>Cub Cadet: 723-04032A; Scag: 48462-01, 48452-01; Snapper: 2-7164; Toro: 67-8110</b>                      Fits Scag and Snapper Hydro models. Toro Groundsmaster 300 series. Fits new ProLine commercial mowers.</p>	--	No	1" - 12	3.66"	3.79"	10	83-012	8631	120-372	\$15.20

	Relief Pressure	Anti-Drain	Thread Size	OD	Height	Micron	Oregon	Rotary	Stens	Price
 <p><b>B1TF702 Transmission Filter</b>                      Cub Cadet: 723-0405; Cushman: 834702; Encore: 445348, 453048, 453058; Exmark: 103-2146; Gravelly: 09414200; Hustler: 783986; Jacobsen: 118017; John Deere: AT38431; MTD: 723-0405; Scag: 48757, 48758; Snapper: 5021357X1; Toro: 23-9740, 54-0110                      PM252H, PM252Z, PM260H, PM260Z and PM272Z. Scag STHM, MAGII, SCR, SM, SMST, SMT, SMTC and STT.</p>	--	No	1" - 12	3-11/16"	5-1/4"	10	83-011	9380	120-818	\$16.30
 <p><b>B1EM61 Transmission Filter</b>                      Dixie Chopper: 68140; Dixon: 7252, 539125960; Exmark: 1-523541; Toro: E63-3752                      Hydrostatic transmission filter.</p>	--	--	3/4" - 16	3"	3-7/8"	40	--	9464	--	\$16.40

**IF YOU WOULD LIKE TO SAVE MONEY...**

**PLACE ALL YOUR BELTING AND PARTS**

**ORDERS WITH US TODAY!!!!**





**Sprockets**



Product No	Description	Price
<b>B1SB472</b>	5/8" ID. 12 teeth. #35 chain.	\$8.30
<b>B1SB473</b>	5/8" ID. 14 teeth. #35 chain.	\$9.10
<b>B1SB475</b>	5/8" ID. 9 teeth. #41 Chain.	\$9.00
<b>B1SB476</b>	5/8" ID. 10 teeth. #41 chain.	\$9.20
<b>B1SB462</b>	3/4" ID for 5/8" clutch. 11 teeth. #35 chain	\$15.10
<b>B1SB463</b>	7/8" ID for 3/4" clutch. 12 teeth. #35 chain.	\$14.70
<b>B1SB464</b>	7/8" ID for 3/4" clutch. 10 teeth. #41 chain.	\$14.70

**Steel Plate Sprockets**

Use with #35 roller chain. 2" CH, Indus pattern. Mounting holes 2" apart.



Product No	Description	Price
<b>B1SB469</b>	7-1/4" OD. 60 teeth.	\$14.90
<b>B1SB470</b>	8-3/4" OD. 72 teeth.	\$18.50
<b>B1SB471</b>	8" OD. 66 teeth.	\$22.80

**Steel Plate Sprockets**

Use with #41 roller chain. 2-1/8" CH, Indus pattern with universal mounting holes 5/16" and 3/8".



Product No	Description	Price
<b>B1SB8247</b>	8" OD. 48 teeth	\$19.50
<b>B1SB8248</b>	9" OD. 54 teeth.	\$23.20
<b>B1SB8249</b>	10" OD. 60 teeth.	\$25.70



**Disc Brake Assembly**

Fits gasoline powered scooters and mini-bikes. Use with our B1SB490 Replacement Brake Pucks.

**B1SB488** \$13.10



**Brake Drum**

2" ID x 4" OD x 1" H. Popular Indus pattern. Universal mounting holes 5/16" and 3/8". Steel.

**B1SB485** \$6.50



**Brake Band and Pin**

Replacement parts for our B1SB485 Brake Drum.

**B1SB486** \$17.40

**Replacement Brake Pucks**

Replacement brake pucks for the most popular disc brakes. Sold in pairs.



Round. 1-1/8" OD, 1/2" H.

**B1SB489** \$2.70



Flat-end type. Use with our B1SB488 Disc Brake Assembly.

**B1SB490** \$2.70



**Brake Cable**

Universal. 65" inner cable. 60" outer casing. Use with our B1SB267 Mini-Bike Wire Swivel Stop.

**B1SB264** \$2.30



**Brake Cable**

For use with disc brakes. Complete with spring and U clamp. 56" length.

**B1SB266** \$5.60

**Key Stock**

Sold in 1 ft. lengths.



Product No	Description	Price
B1SB5600	3/16"	\$1.45
B1SB5601	1/4"	\$2.00
B1SB5602	5/16"	\$2.40
B1SB5603	3/8"	\$2.90

**Mini-Bike Throttle Cables**

Complete with inner cable and housing. Ball on one end, barrel on the other.



Product No	Description	Price
B1SB261	For 48" control. 43" outer casing. Use with our B1SB267 Mini-Bike Wire Swivel stop.	\$3.40
B1SB262	For 53" control. 48" outer casing.	\$2.30
B1SB263	For 60" control. 55" outer casing. Use with our B1SB267 Mini-Bike Wire Swivel Stop.	\$2.40
B1SB269	For use on all terrain vehicles. 100" cable length. 90" outer casing. Use with our B1SB267 Mini-Bike Wire Swivel Stop.	\$6.20

**Kill Switches** 48" lead wire. For use on go-karts, ATV, etc.



Product No	Description	Price
B1WE2	Kill Switch	\$3.00
B1SB7728	Toggle type	\$5.40

**Mini-Bike Throttle Controls**

With twist grip and dummy grip (metal). Sold as a set.



Product No	Description	Price
B1SB257	For 7/8" handle	\$15.00
B1SB258	For 1" handle	\$17.80



**Twist Grip Ferrule**

Used on many twist grips to hold housing in place. Order in multiples of 10.

**B1SB268** \$1.80



**Mini-Bike Wire Swivel Stop**

Universal wire stop. Use with our B1SB261, B1SB269, and B1SB264 throttles and B1SB264 brake. Also works as a wire swivel. Order in multiples of 10.

**B1SB267** \$0.60



**Wire Stop**

Used to secure inner wire to engine. Order in multiples of 10.

**B1SB219** \$1.30

**Grease lubrication points**

Most equipment manufacturers recommend greasing lubrication points every 25 hours. In some cases, failure to follow this guideline can void the equipment warranty.





**Max-Torque Clutches**

Max-Torque clutches are designed, engineered and manufactured to deliver exceptional performance. They are unique and original in design and engineering. Others have copied the design, but they are not able to duplicate the performance and reliability engineered into the Max-Torque clutch.

Product No	Description	Price
<b>B1SB864</b>	3.2" OD, 3/4" ID. For A or B section belts.	\$63.00
<b>B1SB455</b>	3/4" ID. 12 teeth. #35 chain.	\$37.00
<b>B1SB456</b>	5/8" ID. 11 teeth. #35 chain.	\$37.00
<b>B1SB457</b>	3/4" ID. 10 teeth. #40, 41, 410 chain.	\$37.00
<b>B1SB458</b>	5/8" ID. 10 teeth. #40, 41, 410 chain.	\$33.00



**Set Screw**

AS-1414-F. Order in multiples of 10.

**B1SB119** \$0.40



**Centrifugal Clutch Key**

3/16" x 3/4". Order in multiples of 10.

**B1SB461** \$0.47

**Max-Torque Max Lube Clutch System**



This patented clutch system is manufactured with special features that extend the life of ordinary centrifugal clutches. For 3/4" crankshafts with 5/16" thread in hole. Grooved bushing for grease retention. Ground sleeve with hole for grease. Patented 3/4" long zerkbolt fitting. Built-in internal key. No set screws required.

Product No	Description	Price
<b>B1SB7680</b>	12 teeth. #35 chain	\$42.00
<b>B1SB7681</b>	10 teeth. #41 chain.	\$42.00
<b>B1SB8489</b>	Replacement zerkbolt fitting	\$6.50

**Clutch Collars**

Complete with set screws.



Product No	Description	Price
<b>B1SB467</b>	Heavy duty. 5/8" ID. 1/2" H	\$1.90
<b>B1SB468</b>	Heavy duty. 3/4" ID. 9/16" H	\$2.00
<b>B1SB7329</b>	Locking. 1" ID. 5/8" H	\$2.10



**Bearing**

Free-spinning bore. For live axles. 1-1/4" ID.

**B1AC63** \$18.00



**Bearing**

1" rear axle bearing. Comes with collar.

**B1AC64** \$12.00

**Spindle Bearing**

3/8" ID. Used in go-kart spindles. High speed.

**B1AC60** \$3.30



**Sprocket Bushings**



For 3/4" clutch. 1" OD x 7/8" ID.

**B1SB465** \$3.20



For 5/8" clutch. 7/8" OD x 3/4" ID.

**B1SB466** \$3.20





**Steering Wheels**

1/2" CH. (3) 1/4" mounting holes. 1-3/8" center-to-center.

Product No.	Description	Price
<b>B1SB5890</b>	10" ID	\$21.80
<b>B124128</b>	12" ID	\$24.70

**Torque-A-Verter Belts**

--

Product No	Description	Price
<b>B1AC393</b>	5/8" x 27-3/8". Comet #200393A.	\$25.00
<b>B1203591</b>	3/4" x 29-9/32". Fits Manco, Carter Brothers, and many other Go-Karts.	\$24.30
<b>B1AC589</b>	3/4" x 27-3/8". Cogged. Comet #203589A	\$18.00



**ATV Cover**

ATV Covers are made of a rugged fabric that won't stretch or shrink. A special coating ensures maximum water repellancy. Covers are UV and mildew-resistant. Each cover features a storage bag, an elastic cord in the bottom hem, and dual rear air vents.

Product No.	Description	Price
<b>B172113</b>	75" L x 45" W x 35" H	\$49.00
<b>B178443</b>	85" L x 48" W x 40" H	\$54.00



**ATV Tank Organizer**

Keep clothing, food, GPS tools and more within easy reach with these handy ATV fuel tank organizers. Installation is quick and easy on all standard ATVs. Attaches to vehicle using gas cap and hook and loop tape. Two zippered pockets keep essentials within easy reach. The foam back helps to damage. Additionally, the heavy-duty UV resistant ProtekX™ Extreme fabric with PVC backing provides extreme weather and abrasion resistance. Comes with 1 year manufacturer's warranty.

<b>B172779</b>	Timber Camo	\$30.00
----------------	-------------	---------

**ATV Starter**



**ATV Starter**

**Honda 31200-HA0-682, 31200-HA0-682, 31200-HA6-682**  
Fits ATC250ES, ATC250SX, and TRX250 models (1985-1986). Short shaft. 12 volts, CCW, 10 tooth.

**B174682** \$178.00



**ATV Starter**

**Polaris 3085394, 3087030**  
ATV bendix gear used on Polaris models from 1985 - 2007.

**B174298** \$186.00



**ATV Starter**

**Polaris 3084981**  
Fits ATP 330/500 (2004-2005), Big Boss 500 (1998-2002), Magnum 2x2/2x4/325/330/500 (1995-2006), Ranger (1998-2007), Scrambler 500 (1997-2007), Sportsman 335/400/450/500 (1996-2007), and Trail Boss 325/330 (00-07). 12 volts, CW, 9 tooth.

**B174299** \$196.00



**ATV Starter**

**Polaris 3084403, 3085393**  
Fits 2-stroke ATV models with 244cc, 283cc, 352cc, and 378cc (1989 - 2006). 12 volts, CW, 9 tooth.

**B174300** \$184.00



**ATV Starter**

**Yamaha 55X-81800-50-00, 55X-81800-51-00, 65X-81880-50-00, YMF-100-1985, YMF-80-1985**  
Fits YFM50 49cc (2004-2006), YFM80 79cc (1986-2007), YFM100 98cc (1985-1992). 12 volts, CW, 9 tooth.

**B174080** \$156.00



**ATV Starter**

**Yamaha 1UY-81890-51-00, 1UY-81890-00-00, 1UY-81890-11, 1YW-81800-50-00, 1YW-81800-51-00, 2HR-81800-51-00, 2HR-81800-52-00**  
Fits YFM350 Big Bear, Raptor, warrior and YFM400 Kodiak (198-2007). 12 volts, CCW, 9 tooth.

**B174350** \$178.00



**ATV and UTV Tires**

Did you know that we carry ATV and UTV tires? See the tires section of the catalog for a complete list of sizes and styles.



Drive Pulleys

**AYP**



	Jaydee Part No.	OEM Part No.	Description	ID	OD	Height	Keyway	Price Each
	B1SB7180	129861 153535	Spindle pulley fits 42" deck models 7147A29, 7167A29 and 7147B29. Fits our B1AY25 and B1RS25 spindle assemblies. Used with our B1AY21 spindle shafts. Steel.	5/8" Splined	5-3/16"	7/8"	--	\$10.70
	B1AY40	136572	Drive pulley for 44", 46", 48", 50", and 54" decks.	.640" Double Hex	5"	--	--	\$30.00
	B1AY33	140186	Double engine pulley, 3-5/8" distance between pulleys.	1" stepped down to 3/4"	Large Pulley 5-1/2"; Small Pulley 3-1/2"	5-3/8"	1/4"	\$50.90
	B1AY31	153531	Steel. Deck pulley fits 36" and 46" cut mowers. Double hex ID.	5/8" Splined	4-5/8"	7/8"	3/16"	\$8.00
	B1AY32	153532	Steel. Spindle pulley for 38" decks. Fits our B1AY25 and B1RS25 spindle assemblies. Used with our B1AY21 and B1RS21 spindle shafts.	5/8" Splined	4-7/8"	31/32"	--	\$8.70
	B1AY41	195945, 197473	Spindle pulley fits newer 42" and 46" decks. Fits our B1RS45 spindle assembly. Use with our B1RS49 spindle shaft.	5/8" Splined	6-1/4"	7/8"	--	\$16.40

**Bobcat**



	Jaydee Part No.	OEM Part No.	Description	ID	OD	Height	Keyway	Price Each
	B1CO135	31008B, 31012A	Replacement engine pulley or spindle pulley. Fits 48" cut mowers.	1"	5-3/4"	1-3/16"	1/4"	\$45.00





**Bobcat**

	Jaydee Part No.	OEM Part No.	Description	ID	OD	Height	Keyway	Price Each
	B1CO137	31011B	Spindle pulley fits 48" cut mowers.	1"	5-3/4"	1-5/8"	1/4"	\$37.50
	B1CO130	38018N, 38456	Jackshaft pulley fits 32", 36" and 48" decks.	5/8"	3-1/2"	1-9/32"	3/16"	\$25.40
	B1SB6608	38183	Transmission to wheel double pulley fits 48" mid-size mowers. A section with hub.	5/8"	7/16"	1-13/16"	3/16"	\$43.00

**Bunton**





	Jaydee Part No.	OEM Part No.	Description	ID	OD	Height	Keyway	Price Each
	B1CO130	PL0636	Jackshaft pulley fits 32", 36" and 48" decks.	5/8"	3-1/2"	1-9/32"	3/16"	\$25.40
	B1SB5883	PL01246	Cast iron engine pulley fits old style 36", 48" and 52" decks. For A and B section belts.	1"	4"	--	1/4"	\$29.50

**Encore**

	Jaydee Part No.	OEM Part No.	Description	ID	OD	Height	Keyway	Price Each
	B1SB5988	36216	Spindle pulley fits 32", 36", 48" and 61" decks. Use with our B1SB6532 tapered hub. For A and B section belts.	Tapered 1-9/16" to 1-5/8"	5-3/4"	7/8"	--	\$40.00
	B1SB6532	--	Tapered Hub. 1/4" keyway, 25mm bore.	--	--	--	1/4"	\$16.40

Drive Pulleys



**Exmark**

	Jaydee Part No.	OEM Part No.	Description	ID	OD	Height	Keyway	Price Each
	B1EM72	1-323256	Transmission pulley fits 36" and 48" commercial walk-behind mowers. Uses 1/2" belt.	1"	2-3/4"	1-1/8"	1/4"	\$23.20
	B1CO130	303072	Jackshaft pulley fits 32", 36" and 48" decks.	5/8"	3-1/2"	1-9/32"	3/16"	\$25.40
	B1CO137	303073	Spindle pulley fits 48" cut mowers.	1"	5-3/4"	1-5/8"	1/4"	\$37.50
	B1EM58	303498	Engine pulley fits 36" commercial walk-behind mowers. Uses 5/8" belt.	1"	6-1/4"	1-1/4"	1/4"	\$40.70

**Gates**

	Jaydee Part No.	OEM Part No.	Description	ID	OD	Height	Keyway	Price Each
	B1SB1262	7800-22	Engine pulley used on 2.2 HP Honda and 2-3 HP Briggs and Stratton. Has set screw and key.	5/8"	2-1/2"	5/8"	3/16"	\$16.00

**Great Dane**

	Jaydee Part No.	OEM Part No.	Description	ID	OD	Height	Keyway	Price Each
	B1GD55	D18083	Spindle pulley. Short hub, 12 splined. Fits our B1GR5 assembly.	7/8" Splined	5-3/4"	3/4"	--	\$28.50
	B1GD45	D18084	Spindle pulley fits Chariot Sr. and Jr. models. Long hub, 12 splined. Fits our B1GR5 spindle assembly.	7/8" Splined	5-3/4"	1-1/8"	--	\$30.50



**Husqvarna**

	Jaydee Part No.	OEM Part No.	Description	ID	OD	Height	Keyway	Price Each
	B1AY40	532 13 65-72	Drive pulley for 44", 46", 48", 50", and 54" decks.	.640" Double Hex	5"	--	--	\$38.40



**Hustler**

	Jaydee Part No.	OEM Part No.	Description	ID	OD	Height	Keyway	Price Each
	B1HS12	783571	Steel. Deck pulley.	15/16"	5-13/16"	7/8"	--	\$21.90



**John Deere**

	Jaydee Part No.	OEM Part No.	Description	ID	OD	Height	Keyway	Price Each
	B1SB1262	M47161	Engine pulley used on 2.2 HP Honda and 2-3 HP Briggs and Stratton. Has set screw and key.	5/8"	2-1/2"	5/8"	3/16"	\$16.00
	B1SB5883	PT8778	Cast iron. Engine pulley fits 36", 48" and 52" decks. For A and B section belts.	1"	4"	--	1/4"	\$29.00

**Kees**

	Jaydee Part No.	OEM Part No.	Description	ID	OD	Height	Keyway	Price Each
	B1CO130	362096, 957582	Jackshaft pulley fits 32", 36" and 48" decks.	5/8"	3-1/2"	1-9/32"	3/16"	\$25.40
	B1CO137	976398	Spindle pulley fits 48" cut mowers.	1"	5-3/4"	1-5/8"	1/4"	\$37.50





**McLane**

	Jaydee Part No.	OEM Part No.	Description	ID	OD	Height	Keyway	Price Each
	B1SB1262	1063	Engine pulley used on 2.2 HP Honda and 2-3 HP Briggs and Stratton. Has set screw and key.	5/8"	2-1/2"	5/8"	3/16"	\$16.00
	B1SB1263	1063-A	Engine pulley used on 3-1/2 HP Honda. Has set screw and key.	3/4"	2-1/2"	5/8"	3/16"	\$16.10



**MTD**

	Jaydee Part No.	OEM Part No.	Description	ID	OD	Height	Keyway	Price Each
	B1SB8657	756-0486	Spindle pulley fits 36" and 38" F deck 600 series tractors. Fits our B1MT17 spindle assembly.	3/4" Splined	5"	2-1/4"	--	\$17.80
	B1MT28	756-0488 753-0635	Stack pulley fits models 660 through 679.3" space between pulleys.	1-1/4" x 1"	Large pulley 5-1/2"; Small Pulley 3-9/16"	5-5/8"	1/4"	\$38.70
	B1SB8965	756-0556	Spindle pulley fits 42" G series deck. Fits our B1MT17 spindle assembly.	3/4" Splined	5-1/2"	2-1/2"	--	\$18.60
	B1MT161	756-0603	Deck pulley for 600 series mowers. Fits our B1MT51 spindle assembly. Used with our B1SB9516 spindle shaft.	12 Point Spline	5"	2-3/4"	--	\$29.30
	B1MT59	756-0638	Double deck pulley fits Yard Machine hydrostatic lawn tractor model series 690 through 699.	1-9/16"	5"	3-1/4"	--	\$46.70







## MTD

	Jaydee Part No.	OEM Part No.	Description	ID	OD	Height	Keyway	Price Each
	B1MT162	756-0658	Double engine pulley fits 600 series mowers.	Top 1", Bottom 1-1/4"	Top 3-1/2", Bottom 5"	6-1/4"	--	\$48.80
	B1MT159	756-0969	Deck pulley fits 600 series mowers.	12 Point Spline	5"	1"	--	\$9.60
	B1MT158	756-0980	Spindle pulley fits 60 series mowers. Fits our B1MT53 spindle assembly. Used with our B1SB9517 spindle shaft.	12 Point Spline	5-3/4"	1"	--	\$10.70
	B1MT160	756-0982B	Double engine pulley fits riding mower models 660 through 679. Without spacer.	Top 1", Bottom 1"	Top 3-1/2", Bottom 5-1/2"	4-7/8"	--	\$29.40
	B1MT126	756-0983B	Double engine pulley fits models 690 through 699 riding mowers. No spacer.	Top 1", Bottom 1"	Top 3-1/2", Bottom 5-1/2"	4-5/8"	--	\$30.00

## Murray

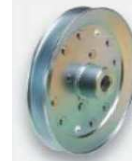

	Jaydee Part No.	OEM Part No.	Description	ID	OD	Height	Keyway	Price Each
	B1SB2926	20615	Jackshaft pulley fits 42" side discharge garden tractor.	5/8"	4-1/2"	--	5/32"	\$9.60
	B1SB2929	021096, 02196MA 21096	Drive pulley.	5/8"	3-3/4"	--	5/32"	\$9.50

**Murray**





	Jaydee Part No.	OEM Part No.	Description	ID	OD	Height	Keyway	Price Each
	B1SB7996	23052	Trans axle pulley fits front engine rider 42", 18 HP models 3-39003 and 3-9004.	3/4"	7"	1-9/32"	3/16"	\$27.50
	B1MU39	23739	Jackshaft pulley for 36" and 42" mowers.	5/8"	5"	--	5/32"	\$12.60
	B1SB7981	55101	Transaxle pulley fits 30" rear engine rider 8 HP, models 8-35500 and 7-30502.	5/8"	7"	1-17/64"	3/16"	\$23.50
	B1SB7993	92127	Right and left spindle pulley. Fits 46" front engine rider 14 and 18 HP, models 46620B, 46620X15A and 46621X92B. Used with our B1SB7282 spindle shaft	9/16" Splined	5"	1-17/64"	--	\$23.40
	B1SB7994	92128	Double spindle pulley (center pulley) fits 46" front engine riders 14 and 18 HP, models 46620B, 46620X15A and 46621X92B	9/16" Splined	5"	2-9/16"	--	\$48.00
	B1SB7995	92425	Spindle pulley fits 42" front engine rider 18 HP, model 42170X9A.	9/16" Splined	6-1/4"	1-13/32"	--	\$35.30
	B1MU53	91769, 91943	Spindle pulley fit 38" front engine rider 12 HP models 38617X5A. 38618X92A and 38608X12D. Used with our B1MU48 spindle shaft.	9/16" Splined	5-1/4"	1-13/32"	--	\$27.70
	B1MU56	91951, 91950 774090	Spindle pulley fits 30" deck on 1990 and newer mowers. For splined shaft models. Used with our B1SB7282 spindle shaft	.600" Splined	7-1/2"	1-3/8"	--	\$30.40



## Power Trim

	Jaydee Part No.	OEM Part No.	Description	ID	OD	Height	Keyway	Price Each
	B1SB3316	307	Edger pulley with 2 set screws	5/8"	2"	1"	3/16"	\$15.70
	B1SB1262	334	Engine pulley used on 2.2 HP Honda and 2-3 HP Briggs and Stratton. Has set screw and key.	5/8"	2-1/2"	5/8"	3/16"	\$16.30
	B1SB1263	334-1	Engine pulley used on 3-1/2 HP Honda. Has set screw and key.	3/4"	2-1/2"	5/8"	3/16"	\$16.50

## Scag

	Jaydee Part No.	OEM Part No.	Description	ID	OD	Height	Keyway	Price Each
	B1SC76	48062	Fits 48" and 61" decks, 1999 and older STHM models.	1-9/16"	5-3/4"	7/8"	--	\$51.60
	B1SB7124	48199	Double jackshaft wheel drive pulley fits 36", 48", 60" and 72" mid-size walk-behind units.	5/8"	3-1/4"	1-3/4"	3/16"	\$44.50
	B1SC92	48586	Pump pulley fits SWZ, Turf Tiger and Cougar models.	9/16"	5-1/2"	1-1/2"	3/16"	\$41.00
	B1SC101	48923	Engine pump pulley fits SWZ, SW, STHM and SSZ models.	1-19/32"	5-13/16"	2-7/64"	--	\$85.50
	B1SB5988	48924 48127-01	Spindle pulley fits 32", 36", 48" and 61" decks. Use with our B1SB6532 tapered hub. For A and B section belts.	Tapered 1-9/16" to 1-5/8"	5-3/4"	7/8"	--	\$43.00



**Scag**

	Jaydee Part No.	OEM Part No.	Description	ID	OD	Height	Keyway	Price Each
	B1SB6532	48141	Tapered Hub. 1/4" keyway. 25mm bore.	1"	2-1/2"	--	1/4"	\$16.40
	B1SC87	48967 482747	Spindle pulley fits Turf Tiger right hand spindles. Used with our B1SC72 spindle assembly and B1SC85 tapered hub.	1-19/32" tapered to 1-19/32"	7"	7/8"	--	\$63.90
	B1SC85	48926	Tapered Hub. Fits Turf Tiger spindles. Fits our B1SC72 spindle assembly. Used with our B1SC86 and B1SC87 spindle pulleys.	1-1/8"	2-15/32"	1-1/4"	1/4"	\$19.90
	B1CO8587	481048	Transmission pulley fits 36", 46" and 52" gear drive commercial mowers. Heavy-duty.	3/8"	3-1/4"	1"	--	\$14.80
	B1SC99	481666	Engine pulley fits SW and SWU walk-behinds.	1"	2-3/4"	1-1/2"	1/4"	\$28.50
	B1SC91	481883	Pump pulley fits Turf Tiger and Tiger Cub models.	1-9/16"	6-1/4"	9/16"	--	\$49.40
	B1SC102	482298	Blower housing and grass catcher pulley fits models GC-STC and GC-SST.	1"	4-3/4"	1-3/8"	1/4"	\$39.20
	B1SC12	482649	Pump shaft pulley fits 40" and 48" decks. Steel without flanges.	Tapered	5-9/20"	--	--	\$27.00

## Scag

	Jaydee Part No.	OEM Part No.	Description	ID	OD	Height	Keyway	Price Each
	B1SC98	482670	Engine pulley fits Turf Tiger models.	1-1/8"	4-7/16"	1-3/8"	1/4"	\$47.70
	B1SC10	482744	Steel. Spindle pulley used with our B1SB6532 tapered hub.	Tapered	5-3/4"	--	--	\$42.40
	B1SC86	482745 48753	Spindle pulley fits Turf Tiger left hand spindles. Used with our B1SC72 spindle assembly and B1SC85 tapered hub.	1-19/32" tapered to 1-19/32"	6-1/4"	7/8"	--	\$64.10
	B1SC14	482746	Gear box spindle pulley fits Turf Tiger model 31BSD. Steel without flanges.	Tapered	4-3/4"	--	--	\$28.60
	B1SC15	482748	Double spindle pulley fits 2005 SWZ walk-behind models. Steel pulley without flanges.	Tapered	5-3/4"	--	--	\$53.80
	B1SC16	482752	Deck pulley fits 2005 Turf Tiger model 31BSD. Steel pulley without flanges.	Tapered	6-1/4"	--	--	\$26.70
	B1SC17	482754	Deck pulley fits 2005 31" through 61" SWZU walk-behind models. Steel pulley without flanges.	1"	4"	--	--	\$31.50
	B1SC18	482755	Pump drive engine pulley fits 2005 SWZ walk-behinds. Steel pulley without flanges.	1"	4-9/20"	--	--	\$24.80





**Scag**

	Jaydee Part No.	OEM Part No.	Description	ID	OD	Height	Keyway	Price Each
	B1SC11	482872	Fits Turf Tiger models. Steel pulley without flanges.	1-1/8"	4-1/4"	--	1/4"	\$23.50
	B1CO7983	481048 48201 483208	Transmission pulley fits 36", 46" and 52" gear drive commercial mowers.	3/8"	3-7/16"	1-3/16"	--	\$15.00



**Snapper**

	Jaydee Part No.	OEM Part No.	Description	ID	OD	Height	Keyway	Price Each
	B1SB9508	24521	Die cast aluminum pulley fits 21" self-propelled models.	3/8"	2"	1-1/4"	--	\$5.00
	B1CO137	76398	Spindle pulley fits 48" cut mowers.	1"	5-3/4"	1-5/8"	1/4"	\$37.50
	B1SB776	1-4397	Spindle pulley fits 41" lawn tractors.	3/4"	5-3/4"	1-5/16"	--	\$17.20
	B1SB438	1-0987	Engine pulley fits 33" rider.	1-1/2" x 1-1/4" (Square D)	5"	1-1/16"	--	\$8.40
	B1SB436	1-8587 1-0787 8781 7-8587 1-5290 1-8781	Spindle pulley fits most rear engine riders 23" to 33" old style.	3/4"	6-7/8"	1-27/64"	--	\$19.40
	B1SN8193	2-1764	Engine pulley for Snappers with Honda engines	7/8"	2-1/8"	7/8"	5/32"	\$16.90
	B1CO130	7-7285 5-7582	Jackshaft pulley fits 32", 36" and 48" decks.	5/8"	3-1/2"	1-9/32"	3/16"	\$25.40

## Ariens

	Jaydee Part No.	OEM Part No.	Description	ID	OD	Height	Price Each
	B1SB2181	01213200	Flat Idler with flanges and heavy-duty bearing. Steel. Fits snow blowers.	5/16"	2-1/2"	--	\$12.60
	B1SB722	07305400	Flat Idler with flanges. Steel.	3/8"	3-7/32"	--	\$9.00
	B1SB2917	07306100	Flat Idler with flanges. Steel.	1/2"	4"	--	\$18.10
	B1SB728	07310900	V-Idler with flanges. Steel.	3/8"	3.060"	--	\$8.80
	B1SB730	07310900	V-Idler with flanges. Steel.	3/8"	3.060"	--	\$8.20

## AYP



	Jaydee Part No.	OEM Part No.	Description	ID	OD	Height	Price Each
	B1SB2176	104679X	Flat Idler with flanges. Steel.	3/8"	3-1/8"	--	\$8.40
	B1SB723	104679X 61620	Flat Idler with Flanges. Steel.	3/8"	3-3/4"	--	\$10.50
	B1SB7157	105315X	Fits Idler. Fits 36" and 42" decks.	3/8"	4-1/4"	1"	\$18.50

**AYP**





	<b>Jaydee Part No.</b>	<b>OEM Part No.</b>	<b>Description</b>	<b>ID</b>	<b>OD</b>	<b>Height</b>	<b>Price Each</b>
	B1AY35	131494	Flat Idler with flanges. Steel. Drive belt and mower deck pulley for many 12 through 22 HP front engine tractors.	3/8"	4-1/4"	1"	\$20.00
	B1AY48	173437	Flat Idler with flanges. Steel. Fits 42" decks, 2000 and later.	3/8"	3.060"	--	\$11.50
	B1AY46	175820	Flat Idler with flanges. Steel. Fits 48" decks, 2001 and later.	3/8"	3 3/4"	--	\$19.70
	B1AY47	177968	Flat Idler with flanges. Steel. Fits 48" decks, 2001 and later.	3/8"	3.060"	--	\$13.10
	B1SB2175	4702H	Flat Idler with flanges and heavy-duty bearing. Steel.	3/8"	2-1/2"	--	\$9.20
	B1SB738	4827H	Flat Idler with flanges and heavy-duty bearing. Steel.	5/8"	2-1/2"	--	\$12.60
	B1SB714	61095	Flat Idler with flanges. Steel.	3/8"	3-1/4"	--	\$9.30
	B1SB731	110484X	V-Idler with flanges. Steel.	3/8"	3.060"	--	\$8.70
	B1AY96	139123	V-Idler. Deck belt idler fits AYP riding mowers.	3/8"	3"	1-1/8"	\$13.70



## AYP

	Jaydee Part No.	OEM Part No.	Description	ID	OD	Height	Price Each
	B1AY49	139245	V-Idler. Heavy-duty. Deck belt idler fits AYP and Husqvarna riding mowers.	3/8"	3-1/2"	1-1/8"	\$15.90
	B1SB2182	195307X	V-Idler with flanges. Steel. For 32", 36" and 48" cut models and 5 speed units.	3/8"	3-9/16"	--	\$8.30
	B1SB729	75672	V-Idler with flanges. Steel.	3/8"	2-5/8"	--	\$8.70



## Bobcat

	Jaydee Part No.	OEM Part No.	Description	ID	OD	Height	Price Each
	B1CO46	38010-1A	Flat Idler with flanges. Steel. Mower blade deck idler.	3/8"	4"	--	\$16.90
	B1CO47	38010-2A	Flat Idler with flanges. Steel. For 32", 36" and 48" cut models and 5 speed units.	3/8"	2-3/4"	--	\$14.80
	B1SB2192	38184-1	Flat Idler without flanges.	3/8"	2-3/4"	1-3/16"	\$9.80
	B1SB7813	38184-2	Flat Idler without flanges. For double "V" drive wheel pulley to gear and positive drive belt. Fits 36", 48", 54" and 61" mid-size.	3/8"	4"	--	\$15.70





## Bolens

	Jaydee Part No.	OEM Part No.	Description	ID	OD	Height	Price Each
	B1SB719	1710566	Flat Idler with flanges. Steel.	3/8"	2.47"	--	\$8.70

**Bolens**

	Jaydee Part No.	OEM Part No.	Description	ID	OD	Height	Price Each
	B1CO47	1713802	Flat Idler with flanges. Steel.	3/8"	2-3/4"	--	\$14.80
	B1SB723	1724488	Flat Idler with flanges. Steel.	3/8"	3-3/4"	--	\$10.50

**Bunton**

	Jaydee Part No.	OEM Part No.	Description	ID	OD	Height	Price Each
	B1CO8005	PL4274	Flat Idler. Fits mid-sized commercial mowers with double wide drive belt. Steel.	3/8"	3-1/2"	1-1/2"	\$12.30
	B1CO7861	PL8036A	Flat Idler. Fits 48" and 52" mid-size Hydro and BHC front engine riders.	3/8"	4-1/2"	1-5/32"	\$12.60
	B1CO7918	PL8540A	V-Idler. Fits 61" and 71" cut Hydro Rider Commercial Machine models.	3/8"	4-7/8"	1-5/32"	\$18.50
	B1SB5869	PL0786	V-Idler with heavy-duty bearing. Steel. Fits model 511 walk-behind mowers with 36" decks. Used on 32", 36", 40" 48" and 52" decks.	3/8"	4"	--	\$13.50



**Case**

	Jaydee Part No.	OEM Part No.	Description	ID	OD	Height	Price Each
	B1SB727	C-15343	Flat Idler with flanges. Steel	3/8"	4-1/2"	--	\$12.10



**Case**

	Jaydee Part No.	OEM Part No.	Description	ID	OD	Height	Price Each
	B1SB719	C-23535	Flat Idler with flanges. Steel	3/8"	2.47"	--	\$8.70

**Cub Cadet**

	Jaydee Part No.	OEM Part No.	Description	ID	OD	Height	Price Each
	B1CO46	756-3005	Flat Idler with flanges. Steel	3/8"	4"	--	\$16.90
	B1SB728	A61176-C92	V-Idler with flanges. Steel. PTO idler.	3/8"	3.060"	--	\$8.80

**Dixie Chopper**

	Jaydee Part No.	OEM Part No.	Description	ID	OD	Height	Price Each
	B1DC75	30224	Fits most 42"-72" decks from 1999-2008	5/8"	4-1/8"	1-3/16"	\$29.60
	B1DC74	30234	Fits most 42"-72" decks from 1999-2008	5/8"	4-5/8"	7/8"	\$21.40

**Dixon**

	Jaydee Part No.	OEM Part No.	Description	ID	OD	Height	Price Each
	B1CO47	1751	Flat Idler with flanges. Steel.	3/8"	2-3/4"	--	\$14.80



**Exmark**

	Jaydee Part No.	OEM Part No.	Description	ID	OD	Height	Price Each
	B1CO8005	--	Flat Idler. Steel. Fits mid-sized commercial mowers with double wide drive belt.	3/8"	3-1/2"	1-1/2"	\$12.30



**Exmark**

	Jaydee Part No.	OEM Part No.	Description	ID	OD	Height	Price Each
	B1EM98	1-633109	Flat Idler. Fits Z Advantage models with 52", 60" and 72" decks and belts on Lazer Z units' Lazer Z models with 52" and 60" Ultra decks, 66" and 72" Triton decks.	21/32"	6-3/4"	1-3/16"	\$31.30
	B1EM54	1-633167 109-4076	Flat Idler. For pump drive belt Fits Lazer Z models with 52" and 60" Ultra decks, 72" Triton deck; Z Advantage models with 52" and 60" decks.	3/8"	3-1/8"	1-3/16"	\$17.20
	B1CO47	303076	Flat Idler with flanges. Steel.	3/8"	2-3/4"	--	\$17.20
	B1EM96	323285	Flat Idler. Fits 36", 48" and 52" Metro walk-behind models.	3/8"	2-3/4"	1-3/8"	\$16.50
	B1SB2917	403009	Flat Idler with flanges. Steel.	1/2"	4"	--	\$18.10
	B1CO46	403009	Flat Idler with flanges. Steel.	3/8"	4"	--	\$16.90
	B1EM97	613098	Flat Idler with flanges. Fits all Z CT and Turf Tracer HP models Z HP models 44", 48", 45" Triton decks; Metro models with 36", 48" decks; Viking models with 48", 52" decks.	17mm	5-1/2"	--	\$17.50
	B1EM100	303516 1-303516	V-Idler with flanges. Steel. Fits Turf Tracer walk-behinds. For use with B section belts.	3/8"	3-15/16"	--	\$15.50

## Exmark

	Jaydee Part No.	OEM Part No.	Description	ID	OD	Height	Price Each
	B1EM106	603805	V-Idler with flanges, deep V. Steel. Fits Lazer Z with 52", 60" Ultra deck and 66", 72" Triton deck; Z advantage with 52", 60", 72" decks; Z XP with 60", 72" decks; all Z XS models	17 mm	5.060"	--	\$22.00
	B1EM53	633166	V-Idler. Pump drive idler for Lazer Z with 52" and 60" Ultra decks, 66" and 72" Triton decks Z advantage models with 52" 60", 72" decks.	11/16"	6"	1-1/8"	\$24.30



## Gilson

	Jaydee Part No.	OEM Part No.	Description	ID	OD	Height	Price Each
	B1SB435	33632	With flanges. Fits Gilson tillers.	5/8"	2"	7/8"	\$8.90
	B1SB727	36374	Flat Idler with flanges. Steel.	3/8"	4-1/2"	--	\$12.10
	B1SB734	24445	V-Idler with flanges. Steel.	3/8"	4"	--	\$9.60





## Grasshopper

		OEM Part No.	Description	ID	OD	Height	Price Each
	B1CO7937	393225	Flat Idler. Composite. Deck tension idler fits models from 1984 through 1994 with 44", 48", and 52" decks. (2 per deck)	1/2"	4-5/8"	31/32"	\$11.60

**Gravely**



	Jaydee	OEM Part	Description	ID	OD	Height	Price Each
	B1SB2917	21060	Flat Idler with flanges. Steel.	1/2"	4"	--	\$18.10
	B1CO46	21060	Flat Idler with flanges. Steel.	3/8"	4"	--	\$16.90
	B1SB2189	34286	Flat Idler with flanges and heavy-duty bearing. Steel.	3/8"	4-1/2"	--	\$20.10

**Great Dane**



	Jaydee Part No.	OEM Part No.	Description	ID	OD	Height	Price Each
	B1GD56	D18044	Flat Idler. Traction drive.	3/8"	5-3/4"	3/4"	\$26.70
	B1GD59	D18314	Flat Idler. Fits Surfer, Chariot and Scamper models.	3/8"	4"	1-3/8"	\$17.90
	B1GD57	D28105	Flat Idler. Fits Chariot models.	3/8"	5-7/8"	3-1/8"	\$42.40
	B1GD58	D18031	V-Idler. Fits Surfer, Chariot and Scamper models.	3/8"	5"	7/8"	\$15.30



## Husqvarna

		OEM Part No.	Description	ID	OD	Height	Price Each
	B1HU56	539102652	Flat Idler. Fits mid-mount zero turn commercial riders.	17 mm	5"	1-1/4"	\$33.60
	B1EM53	539102657	V-Idler. Fits mid-mount zero turn commercial riders.	11/16"	6"	1-1/8"	\$24.30



## Hustler

		OEM Part No.	Description	ID	OD	Height	Price Each
	B1HS15	781385	Flat Idler. Fits 52", 54", 60" and 72" Z, 52", 60", 66" and 72" Super Z, 44" and 52" Mini Z and Super Mini Z, 60" and 72" ATZ models.	11/16"	6-3/4"	1-1/2"	\$33.00
	B1HS16	781856	Flat Idler. Fits 52", 54", 60" and 72" Z, 52", 60", 66" and 72" Super Z, 44" and 52" Mini Z and Super Mini Z, 60" and 72" ATZ models.	11/16"	5-1/2"	1-5/16"	\$33.00

## Jacobsen

		OEM Part No.	Description	ID	OD	Height	Price Each
	B1SB2916	317726	Flat Idler with flanges. Steel.	1/2"	2-3/4"	--	\$11.80





## John Deere

		OEM Part No.	Description	ID	OD	Height	Price Each
	B1JD68	AM106627	Fits 100-series, 200-series, 300-series, F500, F700, G100 GT200, GX255, GX300, LT100 LX100, LX200, STX38, STX46 X300, X400, X500, X700, Z445 Z510A, Z520A, Z465, Z710A, Z720A.	21/32"	5-7/16"	1"	\$13.20
	B1SB725	AM35585	Flat Idler with flanges. Steel.	3/8"	3-5/8"	--	\$10.50

## John Deere

		OEM Part No.	Description	ID	OD	Height	Price Each
	B1SB727	AM35590	Flat Idler with flanges.	3/8"	4-1/2"	--	\$12.10
	B1JD20	GX20287	Flat Idler. Fits X130R, X140 and L100 series mowers with 42", 44" and 46" decks.	11/16"	3-11/32"	1"	\$9.50
	B1JD22	GY20067	Flat Idler. Fits L100 and LA100 series mowers with 42", 44", and 46" decks; Sabre models 14542GS, 1642HS, 1742HS and Scotts models L1742, L17542, L2048 and L2548	11/16"	3-5/8"	1-3/16"	\$7.10
	B1JD11	GY20629	Flat Idler with flanges. Steel. Fits L100 and LA100 series mowers with 42", 44", and 46" Decks	2/3"	4-1/2"	--	\$8.50
	B1SB2181	M124285	Flat Idler with flanges and heavy-duty bearing. Steel. Fits snow blowers.	5/16"	2-1/2"	--	\$12.60
	B1SB2916	PT8649	Flat Idler with flanges. Steel.	1/2"	2-3/4"	--	\$11.80
	B1CO47	PT8649	Flat Idler with flanges. Steel.	3/8"	2-3/4"	--	\$14.80
	B1SB2183	AM32369	V-Idler. For tractor mounted snow thrower models 32, 32A 321, 338, 37, 37A and 38. Steel.	4-1/2"	3/8"	--	\$17.80

**John Deere**

		OEM Part No.	Description	ID	OD	Height	Price Each
	B1SB734R	AM33574	V-Idler with flanges. Steel.	3/8"	4"	--	\$9.60
	B1SB734R	AM33574	V-Idler. Steel, heavy-duty style. Fits material collection system for F620, F680, F687 and Z-Trak	3/8"	4"	--	\$11.50
	B1JD23	GX20286	V-Idler. Fits Sabre models 14542GS, 164HS, 1742HS, 17542HS and Scotts L1742, L17542, L2048 and L2548	11/16"	2-7/8"	21/32"	\$5.50
	B1SB5869	PT8761 AM106564	V-Idler with heavy-duty bearing. Steel. Fits 1990 commercial walk-behind models with 32", 36", 48" and 52" decks.	3/8"	4"	--	\$13.50

**Kees**

		OEM Part No.	Description	ID	OD	Height	Price Each
	B1CO47	919078	Flat Idler with flanges. Steel.	3/8"	2-3/4"	--	\$14.80

**Lawn Boy**

		OEM Part No.	Description	ID	OD	Height	Price Each
	B1SB734	703715	V-Idler with flanges. Steel.	3/8"	4"	--	\$9.60

**MTD**

		OEM Part No.	Description	ID	OD	Height	Price Each
	B1MT402	01004101 02004447	Flat Idler with flanges. Steel. Fits Cub Cadet Z-Force with 44", 50" decks.	3/8"	4.06"	--	\$23.00

**MTD**

		OEM Part No.	Description	ID	OD	Height	Price Each
	B1MT401	1004081	Flat Idler with flanges. Steel.	3/8"	4"	--	\$14.00
	B1MT56	753-0518	Flat Idler. Fits self-propelled walk-behind mowers. Includes hex bolt and bearing.	3/8"	1-1/2"	1/2"	\$9.50
	B1SB720	756-0117	Flat Idler with flanges. Steel.	3/8"	2-15/32"	--	\$8.70
	B1SB719	756-0137	Flat Idler with flanges. Steel.	3/8"	2.47"	--	\$8.70
	B1SB2191	756-0178	Flat Idler without flanges.	3/8"	2-3/4"	1-3/16"	\$9.80
	B1SB718	756-0199	Flat Idler with flanges. Steel.	3/8"	2"	--	\$8.20
	B1SB721	756-0217	Flat Idler with flanges. Steel.	3/8"	3-1/4"	--	\$15.70
	B1CO47	756-0217 756-0178	Flat Idler with flanges. Steel.	3/8"	2-3/4"	--	\$14.80

**Grease moving parts**





Most equipment manufacturers recommend greasing lubrication points every 25 hours. In some cases, failure to follow this guideline can void the equipment warranty.





## MTD

		OEM Part No.	Description	ID	OD	Height	Price Each
	B1SB2192	756-0218	Flat Idler without flanges.	3/8"	3-1/4"	1-5/16"	\$10.00
	B1SB2176	756-0225	Flat Idler with flanges - Steel.	3/8"	3-1/8"	--	\$8.40
	B1SB722	756-0240	Flat Idler with flanges - Steel.	3/8"	3-7/32"	--	\$9.00
	B1SB8583	756-0437 956-0437	Flat Idler with flanges - Steel. Fits 600 series tractors.	3/8"	4"	--	\$9.00
	B1SB723	756-0515	Flat Idler with flanges - Steel.	3/8"	3-3/4"	--	\$10.50
	B1SB8602	756-0627	Flat Idler with flanges. Nylon. Fits 46" front engine rider models 144P820H000 through 144P849H000.	17 mm	4-1/8"	--	\$11.40
	B1SB715	956-0313	Flat Idler with flanges.	3/8"	2-1/8"	--	\$7.90
	B1SB728	756-0116	V-Idler with flanges. Steel.	3/8"	3.060"	--	\$8.80
	B1SB729	756-0166	V-Idler with flanges. Steel.	3/8"	2-5/8"	--	\$8.70

**MTD**

		OEM Part No.	Description	ID	OD	Height	Price Each
	B1SB734	756-0226 756-0293A	V-Idler with flanges. Steel.	3/8"	4"	--	\$9.60
	B1SB734R	756-0226 756-0293A	V-Idler without flanges. Steel, heavy-duty.	3/8"	4"	--	\$11.50
	B1SB5869	756-0293	V-Idler with heavy-duty bearing. Steel.	3/8"	4"	--	\$13.50
	B1SB732	756-0492	V-Idler. Steel.	3/8"	3-1/8"	--	\$9.20
	B1MT400	956-3045	V-Idler without flanges. Steel. Fits 48" GT series tractors.	3/8"	5.060"	--	\$24.70

**Murray**

		OEM Part No.	Description	ID	OD	Height	Price Each
	B1SB2916	21409 42109	Flat Idler with flanges. Steel.	1/2"	2-3/4"	--	\$11.80
	B1SB2917	23238 423238	Flat Idler with flanges. Steel.	1/2"	4"	--	\$18.10
	B1SB2915	23339 023339MA	Flat Idler with flanges and heavy-duty bearing. Steel.	1/2"	4"	--	\$11.80



**Murray**

		OEM Part No.	Description	ID	OD	Height	Price Each
	B1MU170	56526	Flat Idler. Drive belt idler on rear engine 25" and 30" riders.	3/8"	2-5/8"	5/8"	\$15.50
	B1SB3236	90118 490118	Flat Idler with flanges. Steel.	1/2"	4"	--	\$22.20
	B1MU7978	91179 42109	Flat Idler with flanges. Composite. Engine to transmission idler. Fits 38", 12 HP lawn tractors 1987 to 1993	1/2"	2-3/4"	--	\$8.80
	B1CO7937	91590 91590MA	Flat Idler for 46" through 52" decks. Composite.	1/2"	4-5/8"	31/32"	\$11.60
	B1SB7126	91801 774089	Flat Idler with flanges. Composite. Deck idler 36", 38", 40" and 46" decks.	1/2"	4"	--	\$10.10
	B1MU171	95068 95272	Flat Idler.	3/8"	6"	1-1/4"	\$19.80
	B1SB2918	20613 420613	V-Idler with heavy-duty bearing. Steel.	1/2"	3"	--	\$11.50
	B1SB2919	23211	V-Idler without flanges. Steel.	1/2"	3-3/4"	--	\$11.00
	B1SB7127	91178	V-Idler without flanges. Composite. Fits 25", 30", 36" rear engine rider models 7-25501, 7-30502, 7-35500.	1/2"	3"		\$8.80



**Noma**

		<b>OEM Part No.</b>	<b>Description</b>	<b>ID</b>	<b>OD</b>	<b>Height</b>	<b>Price Each</b>
	B1SB719	27332	Flat Idler with flanges. Steel.	3/8"	2.47"	--	\$8.70
	B1SB2916	300920	Flat Idler with flanges. Steel.	1/2"	2-3/4"	--	\$11.80
	B1SB721	300920	Flat Idler with flanges. Steel.	3/8"	3-1/4"	--	\$15.70
	B1SB7182	310326	Flat Idler. Composite. Fits 38", 39", 40", 42", 43" and 46" front engine riders, models B3812-160, C3912-090, B4013-030, B4213-010, B4314-040, B4618-021	3/8"	4"	--	\$8.40
	B1SB722	313850 51448	Flat Idler with flanges. Steel.	3/8"	3-7/32"	--	\$9.00
	B1SB714	39498	Flat Idler with flanges. Steel.	3/8"	3-1/4"	--	\$9.30
	B1CO47	40223	Flat Idler with flanges. Steel.	3/8"	2-3/4"	--	\$14.80
	B1SB2915	40501 2339	Flat Idler with flanges and heavy-duty bearing. Steel.	1/2"	4"	--	\$11.80

**Noma**

		OEM Part No.	Description	ID	OD	Height	Price Each
	B1SB724	46476	Flat Idler with flanges. Steel.	3/8"	3-1/2"	--	\$10.40
	B1SB726	57736	Flat Idler with flanges. Steel.	3/8"	4-1/2"	--	\$11.80
	B1SB718	583391	Flat Idler with flanges. Steel.	3/8"	2"	--	\$8.20
	B1SB733	27788	V-Idler with flanges. Steel.	3/8"	4"	--	\$11.50
	B1SB734	6826 44280	V-Idler with flanges. Steel.	3/8"	4"	--	\$9.60
	B1SB734R	6826 44280	V-Idler without flanges. Steel. Heavy-duty.	3/8"	4"	--	\$11.50

**Scag**

		OEM Part No.	Description	ID	OD	Height	Price Each
	B1SB7813	438184-2	Flat Idler without flanges for double "V" drive wheel pulley to gear and positive drive belt. Fits 36", 48", 54" and 61" mid-size.	3/8"	4"	--	\$15.70
	B1SB2917	48068	Flat Idler with flanges. Steel.	1/2"	4"	--	\$18.10

Scag

		OEM Part No.	Description	ID	OD	Height	Price Each
	B1CO46	48068	Flat Idler with flanges. Steel.	3/8"	4"	--	\$16.90
	B1SC82	481962	Flat Idler, heavy-duty. Fits Tiger Cub models with 48" and 52" decks, SWU models with 36" and 48" decks and SWZU models.	3/8"	5"	2-1/2"	\$73.00
	B1SB5712	48198 483211	Flat Idler with flanges and heavy-duty bearing. Steel pump idler fits SW models with 32", 36", 48" and 52" and SWU models with 36" and 48" decks.	3/8"	5-3/16"	--	\$16.30
	B1SC13	482416 483215	Flat Idler with flanges. Steel. Fits all deck sizes for models Sabre Tooth Tiger, Tiger Cub, Turf Tiger, Wildcat, STHM, SW SWZ and 52", 61" SWZU.	3/8"	5"	--	\$44.50
	B1SB6572	48269	Flat Idler with heavy-duty bearing. Steel. Fits Turf Tiger models with 52" and 61" decks and SW models with 32", 36", 48" and 52" decks.	3/8"	5-15/16"	--	\$16.30
	B1SC28	483210	Flat Idler with flanges. Steel. Fits all deck sizes for models Tiger Cub, Wildcat and SWZU.	3/8"	5"	--	\$42.40
	B1SC90	482062	V-Idler. Fits units with built-on blower system for grass catchers.	3/8"	4"	15/16"	\$30.30
	B1CO7918	482217	V-Idler. Fits 48" and 52" Tiger Cub.	3/8"	4-7/8"	1-5/32"	\$18.50





**Scag**

		OEM Part No.	Description	ID	OD	Height	Price Each
	B1GD58	482217	V-Idler. Fits 48" and 52" Tiger Cub.	3/8"	5"	7/8"	\$15.30

**Simplicity**

		OEM Part No.	Description	ID	OD	Height	Price Each
	B1SB723	108386	Flat Idler with flanges. Steel.	3/8"	3-3/4"	--	\$10.50

**Snapper**

		OEM Part No.	Description	ID	OD	Height	Price Each
	B1SB3478	12124	Flat Idler with flanges. Steel. Fits self-propelled 21" commercial series mowers.	1/4"	2-1/4"	--	\$6.50
	B1SB715	1-2124	Flat Idler with flanges.	3/8"	2-1/8"	--	\$7.90
	B1SB719	1-3850	Flat Idler with flanges. Steel.	3/8"	2.47"	--	\$8.70
	B1SB2175	1-4340	Flat Idler with heavy-duty bearing. Steel.	3/8"	2-1/2"	--	\$9.20
	B1SB777	1-8585	Flat Idler with flanges. Steel. Deck belt idler fits LT11, 12, 16 series tractors with 41" decks. Also used on 48" decks. Two per deck	3/8"	4-7/8"	--	\$16.10

## Snapper

		OEM Part No.	Description	ID	OD	Height	Price Each
	B1CO46	1-8585 76500	Flat Idler with flanges.	3/8"	4"	--	\$16.90
	B1SB2917	1-8585 7-6500 7-6688	Flat Idler with flanges. Steel.	1/2"	4"	--	\$18.10
	B1CO8005	19078	Flat Idler. Steel. Fits mid-sized commercial mowers with double wide drive belt.	3/8"	3-1/2"	1-1/2"	\$12.30
	B1SB8245	2-4725	Flat Idler with flanges. Steel. Tension idler fits 12 and 14 HP front engine riders with 38" decks.	3/8"	4-1/8"	--	\$21.90
	B1SB2189	57582	Flat Idler with flanges.	3/8"	4-1/2"	--	\$20.10
	B1CO47	7-6520	Flat Idler with flanges. Steel.	3/8"	2-3/4"	--	\$14.80
	B1SB734	1-1029	V-Idler with flanges. Steel.	3/8"	4"	--	\$9.60
	B1SB734R	1-1029	V-Idler without flanges. Steel. Heavy-duty.	3/8"	4"	--	\$11.50
	B1SB729	14208	V-Idler with flanges. Steel.	3/8"	2-5/8"	--	\$8.70



**Snapper**

		OEM Part No.	Description	ID	OD	Height	Price Each
	B1SB5870	1-8651	V-Idler. Steel. Mule drive assembly idler with heavy-duty bearing. Used on LT11, 12 and 16 Series tractors with 41" decks. Also used on other 48" decks. Two per deck.	3/8"	4-1/2"	--	\$17.90

**Toro**

		OEM Part No.	Description	ID	OD	Height	Price Each
	B1CO8373	104975	Flat Idler. Steel. Fits Garden Tractor models 300, 400, 500.	3/4"	4-1/8"	1-1/8"	\$20.50
	B1SB722	2-4463	Flat Idler with flanges. Steel.	3/8"	3-7/32"	--	\$9.00
	B1SB719	3-4244	Flat Idler with flanges. Steel.	3/8"	2.47"	--	\$8.70
	B1SB727	55-8260	Flat Idler with flanges. Steel.	3/8"	4-1/2"	--	\$12.10
	B1SB7278	46-5650	V-Idler. Fits all 21" BBC models	15/32"	2-7/8"	27/32"	\$10.20
	B1SB734R	52-4580	V-Idler without flanges. Steel, heavy-duty.	3/8"	4"	--	\$11.50
	B1SB2918	7-0823 62-4530	V-Idler with heavy-duty bearing. Steel.	1/2"	3"	--	\$11.50





### Toro

		OEM Part No.	Description	ID	OD	Height	Price Each
	B1SB8829	92-7103 104974	V-Idler. Fits Garden Tractor models 300, 400 and 500.	3/4"	4-1/4"	13/16"	\$22.50

### Troy Bilt

		OEM Part No.	Description	ID	OD	Height	Price Each
	B1SB2175	1754637	Flat Idler with heavy-duty bearing. Steel.	3/8"	2-1/2"	--	\$9.20



### Wheel Horse

		OEM Part No.	Description	ID	OD	Height	Price Each
	B1SB722	112426	Flat Idler with flanges. Steel.	3/8"	3-7/32"	--	\$9.00
	B1SB719	MW8821	Flat Idler with flanges. Steel.	3/8"	2.47"	--	\$8.70
	B1SB734	7451	V-Idler with flanges. Steel.	3/8"	4"	--	\$9.60
	B1SB734R	7451	V-Idler without flanges. Steel, heavy-duty.	3/8"	4"	--	\$11.50

### Wright

		OEM Part No.	Description	ID	OD	Height	Price Each
	B1SB727	71460006	Flat Idler with flanges. Steel.	3/8"	4-1/2"	--	\$12.10

**Yazoo**

		OEM Part No.	Description	ID	OD	Height	Price Each
	B1HU56	102652	Flat Idler. Fits mid-mount, zero turn commercial riders.	17 mm	5"	1-1/4"	\$33.60
	96	639-19087	Flat Idler.	3/8"	2-3/4"	1-3/8"	\$16.50
	B1EM53	102657	V-Idler. Fits mid-mount zero turn commercial riders.	11/16"	6"	1-1/8"	\$24.30

**DID YOU KNOW THAT WE CARRY A COMPLETE LINE  
OF BELTS FOR... ALL TERRAIN AND UTILITY VEHICLES,  
GOLF CARTS, GO KARTS, AND SNOW MOBILES??**

**CHECK US OUT - [WWW.JDV-BELTS.COM](http://WWW.JDV-BELTS.COM)!!**

**OR CALL US TOLL FREE AT 800-989-0162**

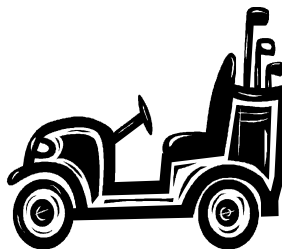
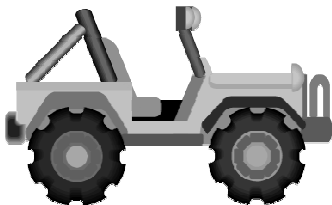

### Idler Pulley Assortment

Assortment contains 24 idlers in 18 of the most popular sizes. Includes pulleys, hooks, and display board.



**B1SB717** \$197.00

Part No.	Part Name	Qty.	Description	Dimensions	Price Each
B1SB718	Flat Idler	2	IF-3011	3/8" ID x 2" OD x 3/4" H	\$8.30
B1SB719	Flat Idler	1	IF-3612	3/8" ID x 2-15/32" OD x 3/4" H	\$8.80
B1SB720	Flat Idler	1	IF-3616	3/8" ID x 2-15/32" OD x 1" H	\$8.80
B1SB728	V-Idler	2	IV39-A	3/8" ID x 3.060" OD x 11/16" H	\$8.90
B1SB731	V-Idler	1	IV48-A	3/8" ID x 3.060" OD x 5/8" H	\$8.80
B1SB730	V-Idler	1	IV42-B	3/8" ID x 3.060" OD x 3/4" H	\$8.30
B1SB722	Flat Idler	1	IF-4812	3/8" ID x 3-7/32" OD x 3/4"	\$9.10
B1SB721	Flat Idler	2	IF-4414	3/8" ID x 3-1/4" OD x 7/8"	\$12.50
B1SB714	Flat Idler	1	IF-4424-2	3/8" ID x 3-1/4" OD x 1-1/4"	\$9.40
B1SB724	Flat Idler	1	IF-5216	3/8" ID x 3-1/2" OD x 1"	\$10.50
B1SB725	Flat Idler	1	IF-5220	3/8" ID x 3-5/8" OD x 1-1/4"	\$10.60
B1SB723	Flat Idler	2	IF-5212	3/8" ID x 3-3/4" OD x 3/4"	\$10.60
B1SB726	Flat Idler	1	IF-6412	3/8" ID x 4-1/2" OD x 3/4"	\$11.90
B1SB727	Flat Idler	1	IF-6416	3/8" ID x 4-1/2" OD x 1"	\$12.30
B1SB729	V-Idler	2	IV40-0	3/8" ID x 2-5/8" OD x 19/32"	\$8.80
B1SB732	V-Idler	1	IV48-0	3/8" ID x 3-1/8" OD x 3/8"	\$9.30
B1SB733	V-Idler	1	IV64-A	3/8" ID x 4" OD x 21/32"	\$11.60
B1SB734	V-Idler	2	IV64-B	3/8" ID x 4" OD x 13/16"	\$9.70

### Composite V-Idler Pulley Assortment

Assortment contains 20 composite V-idlers. Order bushing assortment B1SB7842 for exact center hole size.

**B1SB10126** \$228.50

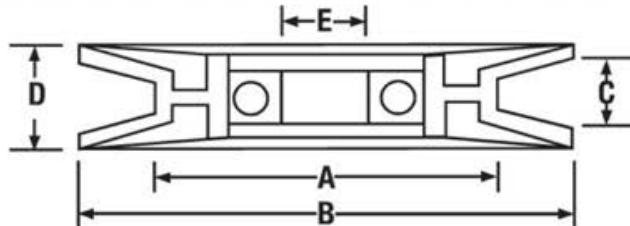

Part No.	Qty.	Description	A	B	C	D	E	Price Each
B1SB10128	2	VIP2000-2.112	1-3/8"	2"	3/8"	5/8"	10mm	\$6.80
B1SB10129	2	VIP2500-2.740	1-3/4"	2-1/2"	1/2"	3/4"	11/16"	\$7.80
B1SB10130	2	VIP2875-3.190	1-3/4"	2-7/8"	1/2"	3/4"	11/16"	\$8.20
B1SB10131	2	VIP3000-3.316	1.96"	3"	1/2"	11/16"	11/16"	\$7.90
B1SB10132	2	VIP3480-3.765	2-37/64"	3-31/64"	1/2"	11/16"	11/16"	\$8.50
B1SB10133	2	VIP3560-3.585	2-1/2"	3-9/16"	37/64"	25/32"	11/16"	\$8.50
B1SB10134	2	VIP4000-4.316	2-5/8"	4"	1/2"	7/8"	11/16"	\$9.00
B1SB10135	2	VIP3000-3.105	1-51/64"	3"	41/64"	13/16"	11/16"	\$7.50
B1SB10136	2	VIP3470-3.575	2-17/64"	3-37/64"	41/64"	13/16"	11/16"	\$8.50
B1SB10137	2	VIP4000-4.105	2-51/64"	4"	41/64"	13/16"	11/16"	\$9.60

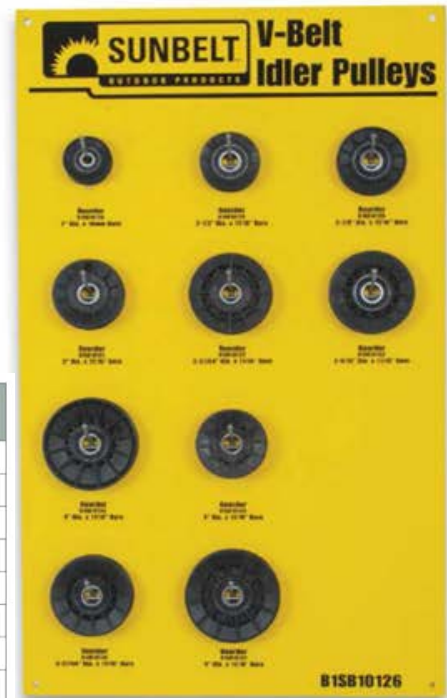



### Composite Flat Idler Assortment

Assortment contains 40 composite flat idlers. Order bushing assortment B1SB7842 for exact center hole size.

B1SB10125

\$338.00

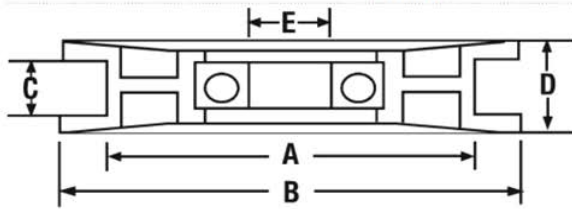

Part No.	ASST. QTY	Description	A	B	C	D	E	Price Each
B1SB10138	2	FIP1750-0.75	1-3/4"	2-7/32"	3/4"	15/16"	11/16"	\$7.40
B1SB10139	2	FIP1875-0.50	1-7/8"	2-1/8"	1/2"	45/64"	11/16"	\$7.40
B1SB10140	2	FIP1875-0.75	1-7/8"	2"	3/4"	31/32"	11/16"	\$7.70
B1SB10141	2	FIP2250-0.75	2-1/4"	2-23/32"	1/16"	15/16"	11/16"	\$7.70
B1SB10142	2	FIP2500-0.75	2-1/2"	2-31/32"	3/4"	1-3/16"	11/16"	\$8.70
B1SB10143	2	FIP2500-1.00	2-1/2"	2-31/32"	1"	1-3/16"	11/16"	\$8.40
B1SB10144	2	FIP2750-0.75	2-3/4"	3-7/32"	3/4"	15/16"	11/16"	\$8.40
B1SB10145	2	FIP2750-0.86	2-3/4"	3-3/16"	23/32"	1-1/16"	11/16"	\$8.70
B1SB10146	2	FIP2750-1.00	2-3/4"	3-7/32"	1"	1-3/16"	11/16"	\$8.70
B1SB10147	2	FIP3000-0.75	3"	3-1/2"	3/4"	1"	11/16"	\$8.70
B1SB10148	2	FIP3000-1.00	3"	3-31/64"	1"	1-3/16"	11/16"	\$8.90
B1SB10149	2	FIP3120-0.75	3-1/8"	4"	3/4"	1-1/8"	11/16"	\$9.70
B1SB10150	2	FIP3500-0.75	3-1/2"	4-1/8"	3/4"	1"	11/16"	\$9.10
B1SB10151	2	FIP3500-0.97	3-1/2"	3-31/32"	1"	15/32"	11/16"	\$9.90
B1SB10152	2	FIP4000-0.75	4"	4-39/64"	23/32"	1-1/16"	11/16"	\$10.20
B1SB10153	2	FIP4000-0.86	4"	4-3/4"	7/8"	1-11/32"	11/16"	\$10.20
B1SB10154	2	FIP4000-1.00	4"	4-5/8"	1"	1-3/16"	11/16"	\$10.20
B1SB10155	2	FIP4500-0.96	4-1/2"	4-31/32"	31/32"	1-1/8"	11/16"	\$10.90
B1SB10156	2	FIP5000-1.25	5"	5-1/2"	1-1/4"	1-1/2"	11/16"	\$15.90
B1SB10157	2	FIP6000-0.75	6"	6-1/2"	1"	1-9/32"	11/16"	\$16.20

### Steel Pulley Assortment

Assortment contains 21 pulleys from 2-1/4" OD x 3/8" ID to 4" OD x 1" ID. They are turned and dressed for "A" section (1/2") belts.

**B1SB749** \$186.00

Part No.	Qty.	Dimensions	Price Each
B1SB751	1	2" OD x 1/2" ID	\$6.30
B1SB752	1	2" OD x 5/8" ID	\$6.80
--	1	2-1/4" OD x 3/8" ID	--
B1SB753	1	2-1/4" OD x 1/2" ID	\$17.30
B1SB754	1	2-1/4" OD x 5/8" ID	\$6.80
--	1	2-1/2" OD x 1/2" ID	--
B1SB756	1	2-1/2" OD x 5/8" ID	\$6.80
B1SB757	1	3" OD x 1/2" ID	\$6.80
B1SB758	1	3" OD x 5/8" ID	\$6.90
B1SB759	1	3" OD x 3/4" ID	\$6.90
--	1	3-1/4" OD x 1/2" ID	--

Part No.	Qty.	Dimensions	Price Each
B1SB761	1	3-1/4" OD x 5/8" ID	\$7.20
B1SB762	1	3-1/4" OD x 3/4" ID	\$6.70
B1SB763	1	3-1/2" OD x 1/2" ID	\$6.80
B1SB764	1	3-1/2" OD x 5/8" ID	\$7.20
B1SB765	1	3-1/2" OD x 3/4" ID	\$7.20
B1SB770	1	3-1/2" OD x 7/8" ID	\$7.80
B1SB773	1	3-1/2" OD x 1" ID	\$8.60
B1SB766	1	4" OD x 1/2" ID	\$7.70
B1SB767	1	4" OD x 5/8" ID	\$8.20
B1SB768	1	4" OD x 3/4" ID	\$7.50



### Idler Bushing Assortment

This assortment contains 114 reducer bushings in 12 of the most popular sizes used in most idler pulley applications.

**B1SB7842** \$107.00



Part No.	Qty.	Dimensions	Price Each
NOPART1	10	.313" ID x .390" Shoulder Height x 12mm HT	\$2.00
NOPART2	10	.375" ID x .270" Shoulder Height x 12mm HT	\$2.00
B1SB7846	10	.375" ID x .310" Shoulder Height x 12mm HT	\$1.60
B1SB7847	10	.375" ID x .410" Shoulder Height x 12mm HT	\$1.60
B1SB7849	10	.375" ID x .460" Shoulder Height x 12mm HT	\$1.60
NOPART3	10	.375" ID x .510" Shoulder Height x 12mm HT	\$2.00
NOPART4	7	.375" ID x .590" Shoulder Height x 12mm HT	\$2.00
NOPART5	10	.500" ID x .270" Shoulder Height x 12mm HT	\$2.00
NOPART6	7	.500" ID x .760" Shoulder Height x 12mm HT	\$2.00
B1SB7851	10	.375" ID x 17mm Shoulder Height x 12mm HT	\$1.60
NOPART7	10	12mm ID x 17mm Shoulder Height x 12mm HT	\$2.00
B1SB7852	10	.500" ID x 17mm Shoulder Height x 12mm HT	\$1.60

### Engine oil

#### Pro Mix Ultra

Professional grade 2-cycle engine oil with semi-synthetic formula provides ultimate protection. 1 gallon mix pouch, 48/case.



**B1AC48** \$1.00

#### Pro Mix

2-cycle engine oil formulated to meet TC-3 Spec and reduce formation of deposits and build-up. 1 gallon mix bottle, 48/case.



**B1AC240** \$1.10

#### SAE 30 Oil

High detergent SAE 30 4-cycle engine oil with superior oxidation and anti-wear properties. 48 oz. bottle, 6/case.



**B1AC50** \$6.90



**Universal V-Belt Idler Pulleys**

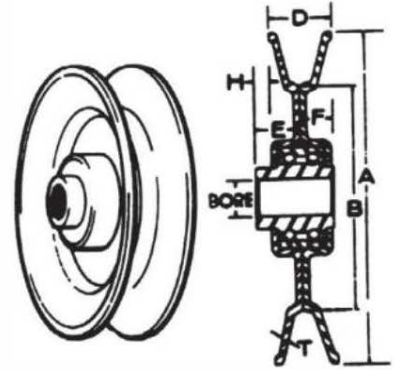

Part No.	Material	Description	A	B	C: Bore	D	E	F	H	T	Price
B1SB729	Steel	IV40-0	2-5/8"	1-3/4"	3/8"	19/32"	1/2"	11/32"	3/16"	.050	\$8.80
B1SB7127	Plastic	--	3"	1-31/32"	1/2"	11/16"	1/4"	1/2"	--	.086	\$8.90
B1SB2918	Steel	IV-80M	3"	2-1/16"	1/2"	1/2"	.240"	.240"	--	.050	\$11.60
B1SB731	Steel	IV48-A	3-1/16"	2"	3/8"	5/8"	1/2"	11/32"	5/32"	.060	\$8.80
B1SB728	Steel	IV39-A	3-1/16"	2"	3/8"	11/16"	1/2"	11/32"	1/8"	.060	\$8.80
B1SB730	Steel	IV42-B	3-1/16"	2"	3/8"	3/4"	1/2"	11/32"	3/32"	.060	\$8.30
B1SB732	Steel	IV48-O	3-1/8"	2-1/8"	3/8"	3/8"	1/2"	11/32"	3/16"	.060	\$9.30
B1SB2182	Steel	--	3-1/2"	2-1/16"	3/8"	3/4"	1/2"	11/32"	1/8"	.060	\$8.40
B1SB2919	Steel	--	3-3/4"	2-9/16"	1/2"	5/8"	.240"	.240"	--	.075	\$11.10
B1SB5869	Steel	--	4"	2-5/8"	3/8"	1"	--	--	3/16"	.074	\$13.60
B1SB734	Steel	IV64-B	4"	2-3/4"	3/8"	13/16"	1/2"	11/32"	3/32"	.060	\$9.70
B1SB733	Steel	IV64-A	4"	3"	3/8"	21/32"	1/2"	11/32"	3/16"	.060	\$11.60
B1SB2183	Steel	--	4-1/2"	3"	3/8"	3/4"	7/32"	--	7/32"	.075	\$18.00
B1SB5870	Steel	--	4-1/2"	3-7/32"	3/8"	3/4"	17/32"	--	--	.074	\$18.10
B1SB10158	Plastic	VIP5000-5.403	5"	4.79"	.64"	.87"	--	11/16"	--	--	\$12.90
B1SB10159	Plastic	VIP6000-6.403	6"	5"	.93"	1.15"	--	11/16"	--	--	\$13.50

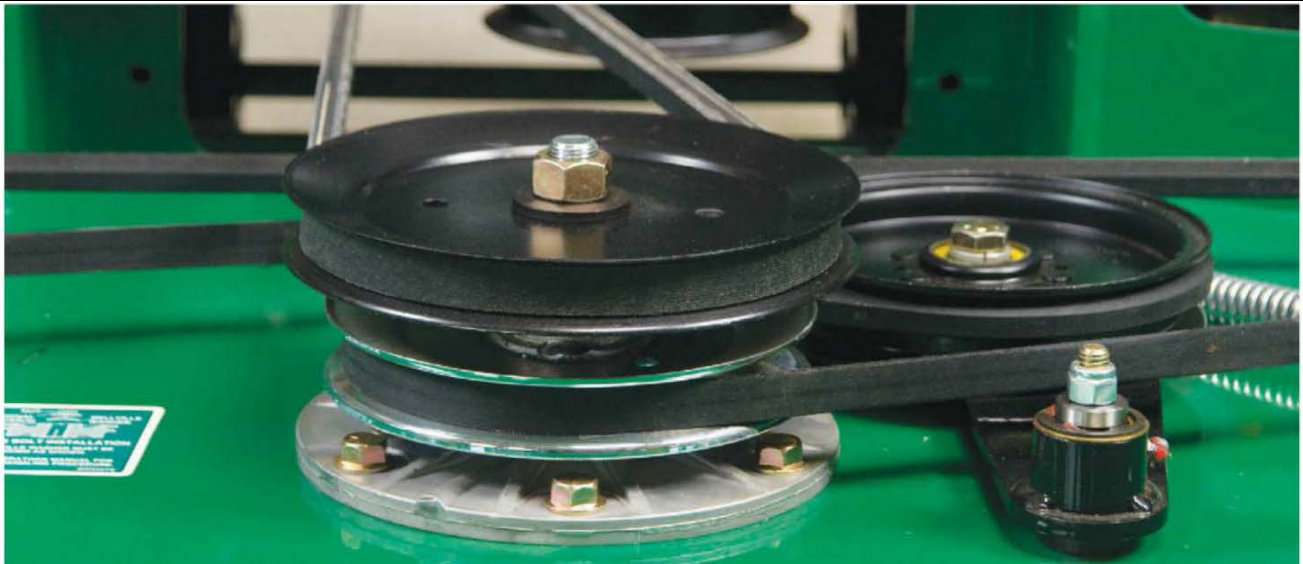

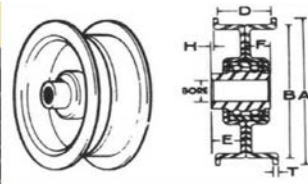

**Universal Flat Idler Pulley with Flanges**

Part No.	Material	Description	A	B	C: Bore	D	E	F	H	T	Price
B1SB718	Steel	--	2"	1-7/8"	3/8"	3/4"	1/2"	11/32"	1/16"	.050"	\$8.30
B1SB715	Steel	--	2-1/8"	1-7/8"	3/8"	1/2"	1/2"	11/32"	1/16"	.050"	\$8.00
B1SB2181	Steel	--	2-1/2"	2"	5/16"	13/16"	3/4"	--	3/32"	.040"	\$12.80
B1SB2175	Steel	--	2-1/2"	2"	3/8"	13/16"	3/4"	11/32"	3/16"	.050"	\$9.30
B1SB738	Steel	--	2-1/2"	2"	5/8"	5/8"	7/32"	7/32"	--	.040"	\$12.80
B1SB719	Steel	--	2-15/32"	2-1/4"	3/8"	3/4"	1/2"	11/32"	1/16"	.050"	\$12.60
B1SB720	Steel	--	2-15/32"	2-1/4"	3/8"	1"	5/8"	11/32"	1/16"	.050"	\$12.60
B1CO47	Steel	--	3-1/32"	2-3/4"	3/8"	7/8"	11/16"	9/32"	1/8"	.047"	\$15.00
B1SB2176	Steel	--	3-1/8"	2-3/4"	3/8"	3/4"	1/2"	11/32"	1/16"	.050"	\$8.50
B1SB2916	Steel	--	3-3/16"	2-3/4"	1/2"	7/8"	.230"	.230"	--	.050"	\$11.90
B1SB722	Steel	--	3-7/32"	3"	3/8"	3/4"	1/2"	11/32"	1/16"	.050"	\$9.10
B1SB714	Steel	--	3-1/4"	2-3/4"	3/8"	1-1/4"	7/8"	11/32"	3/32"	.050"	\$9.40
B1SB721	Steel	--	3-1/4"	2-3/4"	3/8"	7/8"	5/8"	11/32"	1/8"	.050"	\$12.50
B1MU7978	Composite	--	3-23/64"	2-3/4"	1/2"	7/8"	1/4"	1/4"	--	.090"	\$8.90
B1CO7983	Composite	--	3-7/16"	3"	3/8"	3/4"	11/16"	15/64"	7/16"	.090"	\$15.20
B1CO8005	Steel	--	3-1/2"	2-3/4"	3/8"	1-1/4"	7/8"	3/8"	9/16"	.074"	\$12.40
B1SB724	Steel	--	3-9/16"	3-1/4"	3/8"	1"	5/8"	11/32"	1/16"	.060"	\$10.50
B1SB725	Steel	--	3-5/8"	3-1/4"	3/8"	1-1/4"	3/4"	11/32"	1/16"	.060"	\$10.60
B1SB723	Steel	--	3-3/4"	3-1/4"	3/8"	3/4"	1/2"	11/32"	1/16"	.060"	\$10.60
B1SB8588	Steel	--	4"	3-1/8"	3/8"	3/4"	3/4"	11/32"	31/64"	.060"	\$9.10
B1SB2915	Steel	--	4"	3-3/8"	1/2"	15/16"	.230"	.230"	--	.050"	\$11.90
B1SB8245	Steel	--	4-1/8"	3-1/4"	3/8"	1-1/4"	1-3/8"	1/4"	1-5/64"	.060"	\$22.10
B1CO8373	Steel	--	4-1/8"	3-15/32"	3/4"	25/32"	--	--	--	.075"	\$20.70
B1SB8602	Steel	--	4-1/8"	3-1/2"	3/8"	7/8"	5/8"	1/4"	17/64"	.125"	\$11.50
B1SB7157	Steel	--	4-1/4"	3-3/4"	3/8"	1"	5/8"	--	3/32"	.060"	\$18.70
B1SB726	Steel	--	4-1/2"	4"	3/8"	3/4"	1/2"	11/32"	1/16"	.040"	\$11.90
B1SB727	Steel	--	4-1/2"	4"	3/8"	1"	5/8"	11/32"	1/16"	.040"	\$12.30
B1CO7861	Composite	--	4-19/32"	4"	3/8"	23/32"	21/32"	1/4"	9/16"	.090"	\$12.80
B1CO7937	Composite	--	4-19/32"	4"	1/2"	23/32"	1/4"	1/4"	--	.090"	\$11.70
B1SB2917	Steel	--	4-9/16"	4"	1/2"	7/8"	.240"	11/32"	3-16"	.074"	\$18.30
B1CO46	Steel	--	4-5/8"	4"	3/8"	11/16"	11/16"	5/16"	1/8"	.074"	\$17.10
B1SB3236	Steel	--	4-3/4"	4"	1/2"	27/32"	.230"	.230"	--	.050"	\$22.50
B1SB7182	Composite	--	4-3/4"	4"	3/8"	7/8"	3/4"	5/16"	1/16"	.090"	\$8.50
B1SB777	Steel	--	4-7/8"	4-1/16"	3/8"	3/4"	5/8"	.236"	1/16"	.075"	\$16.30
B1SB5712	Steel	--	5-3/16"	5"	3/8"	1-3/16"	1"	5/16"	3/16"	.074"	\$16.40
B1SB6572	Steel	--	5-15/16"	5"	3/8"	1-1/4"	3/4"	9/32"	1/16"	.074"	\$16.40

**Universal Flat Idler Pulley without Flanges**

B1SB2190	IP-3620			2-1/4"	3/8"	1-1/4"	3/4"	11/32"	1/8"	.050"	\$10.20
B1SB2191	IP-4420			2-3/4"	3/8"	1-3/16"	3/4"	11/32"	1/8"	.050"	\$9.90
B1SB2192	IP-2192			3-1/4"	3/8"	1-5/16"	3/4"	11/32"	1/8"	.060"	\$10.20
B1SB7813	--			4"	3/8"	1-9/16"	3/4"	13/16"	7/16"	.060"	\$13.30

## Universal Cast Iron Pulleys



Part No	Dimensions	Price	Part No	Dimensions	Price
B1SB5963	2" OD x 3/4" ID x 3/16" keyway	\$16.80	B1SB5880	3" OD x 1" ID x 1/4" keyway	\$19.40
B1SB5965	2-1/4" OD x 5/8" ID x 3/16" keyway	\$16.80	B1SB5983	3-1/2" OD x 7/8" ID x 3/16" keyway	\$19.50
B1SB5966	2-1/4" OD x 3/4" ID x 3/16" keyway	\$16.80	B1SB5984	3-1/2" OD x 1" ID x 1/4" keyway	\$19.50
B1SB5967	2-1/4" OD x 7/8" ID x 3/16" keyway	\$17.10	B1SB5882	4" OD x 3/4" ID x 3/16" keyway	\$24.20
B1SB5969	2-1/2" OD x 5/8" ID x 3/16" keyway	\$17.10	B1SB5986	4" OD x 7/8" ID x 3/16" keyway	\$24.20
B1SB5970	2-1/2" OD x 3/4" ID x 3/16" keyway	\$17.10	B1SB5883	4" OD x 1" ID x 1/4" keyway	\$24.20
B1SB5973	2-3/4" OD x 5/8" ID x 3/16" keyway	\$17.90	B1SB5884	5" OD x 3/4" ID x 3/16" keyway	\$30.40
B1SB5974	2-3/4" OD x 3/4" ID x 3/16" keyway	\$17.90	B1SB5885	5" OD x 1" ID x 1/4" keyway	\$30.40
B1SB5976	2-3/4" OD x 1" ID x 1/4" keyway	\$18.40	B1SB5887	5-3/4" OD x 3/4" ID x 3/16" keyway	\$34.40
B1SB5879	3" OD x 3/4" ID x 3/16" keyway	\$19.40	B1SB5997	6" OD x 1" ID x 1/4" keyway	\$33.70



## Universal Die Cast Pulleys



## Universal Steel V-Belt Pulley

Part No.	Description	Dimensions	Price
B1SB680	150A12	1-1/2" OD x 1/2" ID	\$5.10
B1SB686	200A34	2" OD x 3/4" ID	\$5.10
B1SB687	225A12	2-1/4" OD x 1/2" ID	\$7.10
B1SB688	225A58	2-1/4" OD x 5/8" ID	\$7.10
B1SB689	225A34	2-1/4" OD x 3/4" ID	\$7.10
B1SB693	300A12	3" OD x 1/2" ID	\$8.70
B1SB696	350A12	3-1/2" OD x 1/2" ID	\$11.80
B1SB697	350A58	3-1/2" OD x 5/8" ID	\$11.40
B1SB699	400A12	4" OD x 1/2" ID	\$12.60
B1SB700	400A58	4" OD x 5/8" ID	\$12.30
B1SB703	450A58	4-1/2" OD x 5/8" ID	\$14.30
B1SB705	500A12	5" OD x 1/2" ID	\$14.30
B1SB706	500A58	5" OD x 5/8" ID	\$14.00
B1SB707	500A34	5" OD x 3/4" ID	\$14.10

Part No	Dimensions	Price
B1SB772	3" OD x 1" ID x 1/4" keyway	\$7.90

## Double Groove Multiple Drive Pulley

Part No	Dimensions	Price
B1SB712	3" OD x 5/8" ID	\$20.30



**Sprocket  
Idlers**

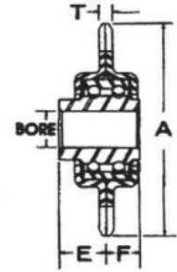
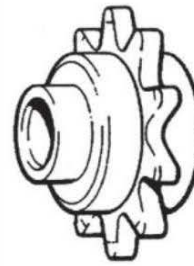

Part No.	Description	A	Bore	E	F	T	Chain Size	Teeth	Price
B1SB736	IS-810	1.84"	3/8"	1/2"	11/32"	1/8"	40, 41	10 teeth	\$9.10
B1SB735	IS-618	2.35"	3/8"	1/2"	11/32"	1/8"	35	18 teeth	\$8.90
B1SB737	IS-814	2.49"	3/8"	1/2"	11/32"	1/8"	40, 41	14 teeth	\$9.10

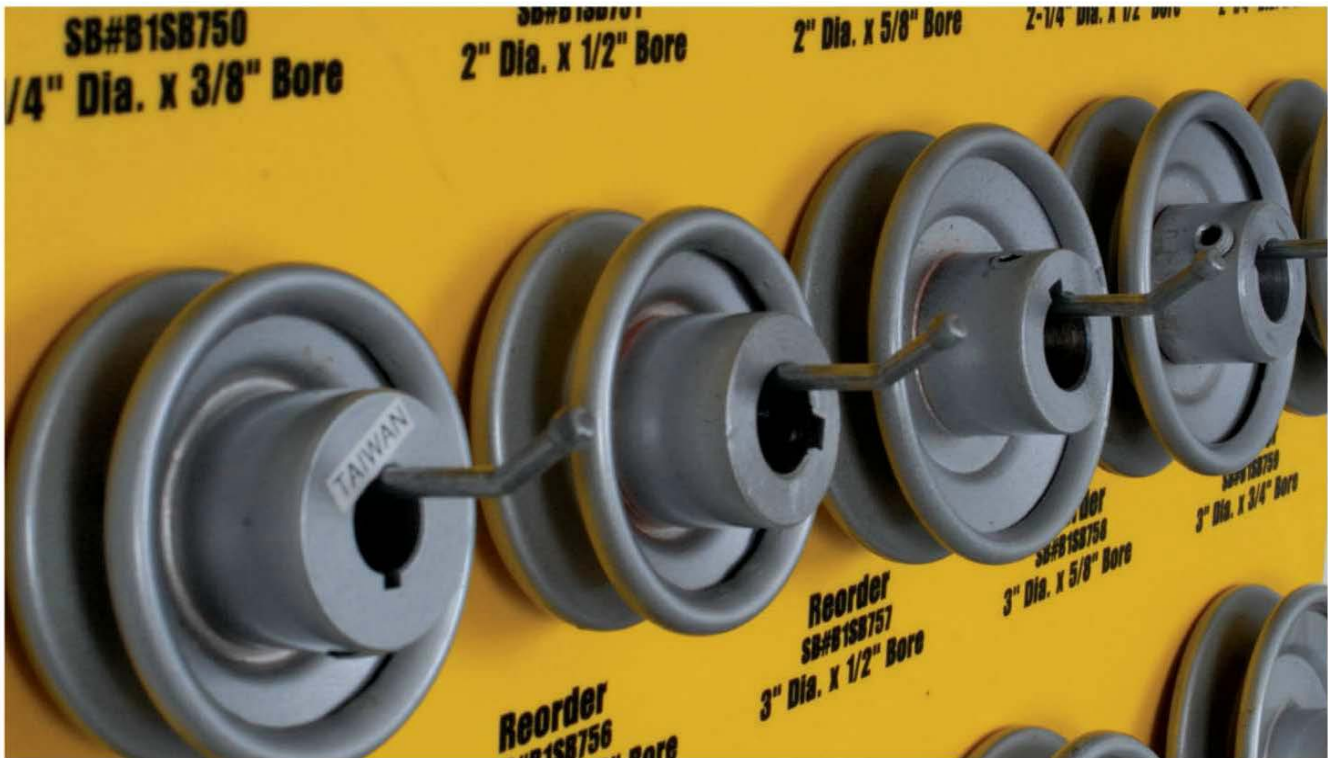

## Hydrostatic Pumps and Motors



We proudly carry original Hydro-Gear pumps, motors, transmissions, filters, and seal kits. Hydro-Gear is a world leader in the design and manufacture of quality hydrostatic drive systems for the lawn and garden industry. Because Hydro-Gear works with the original equipment suppliers, you can be sure that these pumps match the exact specifications and requirements of your equipment.



### Ariens

Product No.	OEM No.	Hydro-Gear No.	Type	Side	Application	Code*	Price
B1HP183	170400	BDP-10A-320, PG-1KQQ-DA1X-XXXX	Pump	RH	HR1536, HR1544	DS	\$436.90
B1HP169	170500	BDP-10A-438, PG-1HQQ-DB1X-XXXX	Pump	LH	HR1536, HR1544	DS	\$436.90
B1HP110	2964300	BDP-10A-316, PG-1KCC-DY1X-XXXX	Pump	--	--	ST	\$426.80
B1HP109	2964600	BDP-10A-300, PG-1KQQ-DY1X-XXXX	Pump	--	--	ST	\$398.00
B1HP113	2964700	BDP-10A-400, PG-1HQQ-DY1X-XXXX	Pump	--	--	ST	\$398.00
B1HP115	9279900	BDP-10L-117, PL-BGQQ-DY1X-XXXX	Pump	--	--	ST	\$513.20
B1HP134	9285200	BDP-10A-441, PG-3HCC-NE1X-XXXX	Pump	RH	Zoom 1844XL, 2044XL, 2148XL, 2348XL, 2552XL, 2560XL, PM144Z, PM34Z	DS	\$514.00
B1HP179	9297600	BDP-10A-333, PG-1KCC-DC1X-XXXX	Pump	LH	PM34Z, Zoom	DS	\$465.80
B1HP111	21545201	BDP-10A-437, PG-1GQQ-DY1X-XXXX	Pump	--	--	ST	\$398.00
B170525	59203600	70525	Seal Kit	--	PM144Z, PM34Z, Zoom 1844XL, 2044XL, 2148XL, 2348XL, 2552XL, 25560XL	ST	\$24.00
B1HP305	00668900	HGM-15E-3051	Wheel Motor	RH	PM144Z	ST	\$658.20
B1HP308	00882300 04915500	HGM-12P-7172	Wheel Motor	--	FX, Zoom	DS	\$449.30

### AYP

Product No.	OEM No.	Hydro-Gear No.	Type	Side	Application	Code*	Price
B1HP121	104529	BDO-10A-404, PG-1GQN-DY1X-XXXX	Pump	--	--	ST	\$398.00

### Bad Boy

Product No.	OEM No.	Hydro-Gear No.	Type	Side	Application	Code*	Price
B1HP133	050-5302-00	PG-3KCC-NY1C-XXXX	Pump	LH	Pup and Lightning models	DS	\$520.90
B1HP305	015-2004-00	HGM-15E-3051	Wheel Motor	RH	Pup and Lightning models	ST	\$658.20

**Bobcat**

Product No.	OEM No.	Hydro-Gear No.	Type	Side	Application	Code*	Price
B1HP116	2308114	BDP-10L-121, PL-BGVQ-DY1X-XXXX	Pump	RH	Walk-Behinds	ST	\$520.90
B1HP121	2721615, 4163316	BDP-10A-404, PG-1GQN-DY1X-XXXX	Pump	RH	Walk-Behinds	ST	\$398.00
B1HP136	38345, PL7343	BDP-10L-119, PL-BGVQ-DY1X-XXXX	Pump	--	--	DS	\$533.30
B1HP175	4112782	BDP-10A-309, PG-1JQN-DY1X-XXXX	Pump	--	Walk-Behinds	DS	\$418.00
B1HP151	4121332	BDP-10A-439, PG-1GAC-DY1X-XXXX	Pump	--	ZT-100 Series	DS	\$446.90
B1HP140	4121333	BDP-10A-440, PG-1HCA-DY1X-XXXX	Pump	--	ZT-100 Series	DS	\$446.90
B1HP301	4156464	ZL-KMEE-3BLC-2FXX	Transaxle	--	FastCat, Rocket	ST	\$726.90

**Bunton**

Product No.	OEM No.	Hydro-Gear No.	Type	Side	Application	Code*	Price
B1HP116	2308114	BDP-10L-121, PL-BGVQ-DY1X-XXXX	Pump	RH	Walk-Behinds	ST	\$520.60
B1HP121	2721615, 4163316	BDP-10A-404, PG-1GQN-DY1X-XXXX	Pump	RH	Walk-Behinds	ST	\$398.00
B1HP136	38345, PL7343	BDP-10L-119, PL-BGVQ-DY1X-XXXX	Pump	--	--	DS	\$533.30
B1HP175	4112782	BDP-10A-309, PG-1JQN-DY1X-XXXX	Pump	--	Walk-Behinds	DS	\$418.00
B1HP151	4121332	BDP-10A-439, PG-1GAC-DY1X-XXXX	Pump	--	ZT-100 Series	DS	\$446.90
B1HP140	4121333	BDP-10A-440, PG-1HCA-DY1X-XXXX	Pump	--	ZT-200 Series	DS	\$446.90
B1HP115	PL6007	BDP-10L-117, PL-BGQQ-DY1X-XXXX	Pump	--	--	ST	\$513.20
B1HP203	PL7343	BDP-10L-126, PL-AAVV-DY2X-XXXX	Pump	--	--	DS	\$533.30
B1HP205	PL7344	BDP-10L-127, PL-AGVV-DY2X-XXXX	Pump	--	--	DS	\$533.30

**Bush Hog**

Product No.	OEM No.	Hydro-Gear No.	Type	Side	Application	Code*	Price
B1HP142	50031043	BDP-10A-410, PG-3HQQ-NY1X-XXXX	Pump	RH	Mid-Mount Zero Turn	DS	\$466.20
B1HP144	50031044	BDP-10A-306, PG-3KQQ-NY1X-XXXX	Pump	LH	Mid-Mount Zero Turn	DS	\$466.20
B1HP113	50032091	BDP-10A-400, PG-1HQQ=DY1X-XXXX	Pump	RH	ZT-180, ZT-220	ST	\$398.00
B1HP109	50032092	BDP-10A-300, PG-1KQQ-DY1X-XXXX	Pump	LH	ZT-180, ZT-220	ST	\$398.00
B1HP115	99079	BDP-10L-117, PL-BGQQ-DY1X-XXXX	Pump	--	ZT18, ZT25	ST	\$513.20
B1HP305	50045356	HGM-15E-3051	Wheel Motor	RH	Commercial Z	ST	\$658.20

**Country Clipper**

Product No.	OEM No.	Hydro-Gear No.	Type	Side	Application	Code*	Price
B1HP131	D-3770-01	PG-1ACC-DY1X-XXXX	Pump	LH	Charger	ST	\$426.80

**Cub Cadet**

Product No.	OEM No.	Hydro-Gear No.	Type	Side	Application	Code*	Price
B1706936	01006936, 01006936P	BDP-10A-103, PG-4DCC-DZ1X-XXXX	Pump	LH	48", 54", 60", 72" Tanks	ST	\$431.10
B1720228	2000228	PG-5KCC-NG1B-XXXX	Pump	RH	Z-Wing	ST	\$519.70
B1720229	2000229	PG-5HCC-NG1B-XXXX	Pump	LH	Z-Wing	ST	\$519.70
B1HP306	01008192, 01008192P	344-2400L, IZT 344-2400L	Transmission	LH	Fits 42", 44", 48", and 50" Z-Force mowers	ST	\$722.60
B1HP302	717-3543	BDU-21L-400	Transmission	--	5000 series tractor	ST	\$849.40

**Dixie Chopper**

Product No.	OEM No.	Hydro-Gear No.	Type	Side	Application	Code*	Price
B1HP128	200028	BDP-10A-418, PG-1HCC-DY1X-XXXX	Pump	RH	LT. Silver Eagle	ST	\$426.80
B1HP110	200029	BDP-10A-316, PG-1KCC-DY1X-XXXX	Pump	LH	LT. Silver Eagle	ST	\$426.80
B1HP123	20044	BDP-10A-418, PG-1HCC-DY1X-XXXX	Pump	--	--	ST	\$475.00



## Hydrostatic Pumps and Motors

### Dixie Chopper

Product No.	OEM No.	Hydro-Gear No.	Type	Side	Application	Code*	Price
B1HP103	65070	BDP-10A-313, PG-DJCC-DY1X-XXXX	Pump	RH	Classic, XW, XF	ST	\$398.90
B1HP102	65071	BDP-10A-207, PG-DACC-DY1X-XXXX	Pump	LH	Classic, XW, XF	ST	\$398.90
B1HP201	990765015	BDP-10L-134, PL-AAQQ-DY1X-XXXX	Pump	--	--	DS	\$533.30
B1HP204	990765016	BDP-10L-500, PL-AGQQ-DY1X-XXXX	Pump	--	--	DS	\$533.30

### Encore

Product No.	OEM No.	Hydro-Gear No.	Type	Side	Application	Code*	Price
B1HP169	423330	BDP-10A-438, PG-1HQQ-BD1X-XXXX	Pump	--	Z-series	DS	\$436.90
B1HP115	453087	BDP-10L-117, PL-BGQQ-DY1X-XXXX	Pump	--	Premier HydroPro Prowler Frontcut, Prowler Midcut, Z Series	ST	\$513.20
B1HP128	583491	BDP-10A-418, PG-1HCC-DY1X-XXXX	Pump	--	Prowler Mid Cut	ST	\$426.80
B1HP166	583491	BDP-10A-460, PG-1HQC-DY1X-XXXX	Pump	--	Prowler Mid Cut	DS	\$432.40

### Exmark

Product No.	OEM No.	Hydro-Gear No.	Type	Side	Application	Code*	Price
B1HP600	109-3321	52114	Filter	--	Fits Hydro-Gear Transmission models ZT-2800, 3100, 3400, G700.	ST	\$10.70
B1HP106	103-1942	BDP-10A-414, PG-1GNP-DY1X-XXXX	Pump	--	Lazer Z, CT, HP	ST	\$398.00
B1HP107	103-1943, 103-2675	BDP-10A-427, PG-1GAB-DY1X-XXXX	Pump	--	Lazer Z, AS	ST	\$426.80
B1HP116	103-2766, 1-603841	BDP-10L-121, PL-BGVQ-DY1X-XXXX	Pump	--	Lazer Z, HP, Viking, Turf Tracer Hydro	ST	\$520.60
B1HP212	103-2766, 1-603841	BDP-10L-503P, PL-BGAC-DY1X-XXXX	Pump	--	Lazer Z, HP, Viking, Turf Tracer Hydro	DS	\$562.90
B1HP104	103-4040	BDP-10A-450, PG-1GEF-DY1X-XXXX	Pump	--	Lazer Z CT	ST	\$426.80
B1HP111	103-4247, 106-5490, 109-4988	BDP-10A-437, PG-1GQQ-DY1X-XXXX	Pump	--	Turf Tracer ECS, Turf Tracer HP, Turf Tracer Hydro, Viking Hydro.	ST	\$398.00
B1HP105	103-4611, 109-4987	BDP-10A-305, PG-1JQQ-DY1X-XXXX	Pump	--	Turf Tracer ECS, Turf Tracer HP, Turf Tracer Hydro, Viking Hydro.	ST	\$398.00
B1HP118	103-7262, 116-2444	PJ-BGAB-EY1X-XXXX	Pump	--	Lazer Z, AS	ST	\$454.90
B1HP136	1-321008, 1-603840, 1-613042	BDP-10L-119, PL-BGQV-DY1X-XXXX	Pump	--	Turf Tracer, Viking	DS	\$533.30
B1HP115	1-321008, 1-613042	BDP-10L-117, PL-BGQQ-DY1X-XXXX	Pump	--	Turf Tacer HP, Turf Tracer Hydro, Viking Hydro	ST	\$513.20
B170525	105-6184	70525	Seal Kit	--	Lazer Z, AS, CT, HP, Navigator, Turf Tracer HP, Turf Tracer Hydro, Viking Hydro	ST	\$24.90
B1HP305	103-5333	HGM-15E-3051	Pump	--	Lazer Z AS, AZ, CT	ST	\$658.20
B1EM44	1-523328	TF0240US081AADD (Parker-Hannifin)	Wheel Motor	--	Explorer, Explorer II, Lazer Z, HP. This is a Parker Hannifin motor, NOT HYDRO-GEAR	ST	\$509.80

## Ferris

Product No.	OEM No.	Hydro-Gear No.	Type	Side	Application	Code*	Price
B1HP116	1522033	BDP-10L-121, PL-BGVQ-DY1X-XXXX	Pump	--	--	ST	\$520.60
B1HP141	22033, 5022033	BDP-10L-502P, PL-BGVP-DY1X-XXXX	Pump	--	ISZ	DS	\$533.30
B1HP112	22571	BDP-10A-432, PG-3GAQ-NZ1X-XXXX	Pump	--	1000Z, IS1000Z, IS3000Z	ST	\$464.90
B1HP214	5023401	BDP-21L-105, PW-1DCC-EY1X-XXXX	Pump	--	IS4500Z, IS5100Z	DS	\$535.80
B1HP129	5100161	PK-3GCC-GZ1F-XXXX	Pump	Both	IS3100Z	ST	\$531.90
B1HP300	5100407	HGM-15E-3138	Wheel Motor	LH	IS1500ZX, IS2000Z	ST	\$662.50

## Grasshopper

Product No.	OEM No.	Hydro-Gear No.	Type	Side	Application	Code*	Price
B1HP111	391457	BDP-10A-437, PG-1GQQ-DY1X-XXXX	Pump	--	--	ST	\$398.00
B1HP198	391457	BDP-10A-406, PG-DGQQ-DY1X-XXXX	Pump	--	--	DS	\$418.00
B1HP155	391459	BDP-10A-461, PG-1GQC-DY1X-XXXX	Pump	--	--	DS	\$432.40
B1HP146	391460	BDP-10A-310, BDP-10A-363, PG-3JQC-NY1X-XXXX	Pump	LH	200-Series Mid Mounts	DS	\$480.70
B1HP145	391461	BDP-10A-416, BDP-10A-463, PG-3GQC-NY1X-XXXX	Pump	RH	200-Series Mid Mounts	DS	\$480.70

## Gravely

Product No.	OEM No.	Hydro-Gear No.	Type	Side	Application	Code*	Price
B1HP183	170400	BDP-10A-320, PG-1KQQ-DA1X-XXXX	Pump	RH	HR1536, HR1544, HR1548	DS	\$436.90
B1HP169	170500	BDP-10A-438, PG-1HQQ-DB1X-XXXX	Pump	LH	HR1536, HR1544, HR1548	DS	\$436.90
B1HP170	4915700	BDP-10A-448, PG-1HQR-DY1X-XXXX	Pump	LH	Walk-Behinds	DS	\$418.00
B1HP186	4915600	BDP-10A-325, PG-1KQR-DY1X-XXXX	Pump	RH	Walk-Behinds	DS	\$418.00
B1HP115	051146, 053330, 08867300, 08867351, 09279900	BDP-10L-117, PL-BGQQ-DY1X-XXXX	Pump	--	--	ST	\$513.20
B1HP134	9285200	BDP-10A-441, PG-3HCC-NE1X-XXXX	Pump	RH	Compact Pro 34, PM34/M/Z, PM44Z, PM144M/XOZ/Z, PM148H/XDZ, PM148H/MZ, PM52M/Z, PM160M/Z, ZT1844XL, ZT2044LP, ZT2044XL, ZT2148XL, ZT2348XL	DS	\$514.00
B1HP179	9297600	BDP-10A-333, PG-1KCC-DC1X-XXXX	Pump	LH	PM, ZT	DS	\$465.80
B1HP305	668900	HGM-15E-3051	Wheel Motor	RH	PM144M, PM148M, PM152M, PM160M, PM320	ST	\$658.20
B1HP308	00882300, 04915500	HGM-12P-7172	Wheel Motor	--	Compact Pro	DS	\$449.30

## Great Dane

Product No.	OEM No.	Hydro-Gear No.	Type	Side	Application	Code*	Price
B1HP143	D18051	BDP-10L-132P, PL-BGRQ-DY1X-XXXX	Pump	--	Gateway and Scamper	DS	\$533.30
B1HP100	D18312	BDP-10A-303, PG-1KRQ-DY1X-XXXX	Pump	--	--	ST	\$398.00
B1HP101	D18313	BDP-10A-403, PG-1HRQ-DY1X-XXXX	Pump	--	--	ST	\$398.00
B1HP132	D28227	BDP-10A-101, PG-1DQP-DY1X-XXXX	Pump	LH	Chariot, Chariot JR	DS	\$418.00
B1HP171	TCA14965	BDP-10A-452, PG-1HRA-DA1X-XXXX	Pump	LH	Super Surfer, Super Surfer II	DS	\$451.30
B1HP135	TCA14966	BDP-10A-329, PG-1KRA-DB1X-XXXX	Pump	RH	Super Surfer, Super Surfer II	DS	\$457.30
B1HP308	TCA15078	HGM-12P-7172	Wheel Motor	--	Super Surfer	DS	\$449.30

## Hydrostatic Pumps and Motors

### Howard Price

Product No.	OEM No.	Hydro-Gear No.	Type	Side	Application	Code*	Price
B1HP114	13-695	BDP-10A-419, PG-1GCC-DY1X-XXXX	Pump	--	--	ST	\$426.80
B1HP115	13-695	BDP-10L-117, PL-BGQQ-DY1X-XXXX	Pump	--	--	ST	\$513.20

### Husqvarna

Product No.	OEM No.	Hydro-Gear No.	Type	Side	Application	Code*	Price
B1HP115	539 10 11-11	BDP-10L-117, PL-BGQQ-DY1X-XXXX	Pump	--	--	ST	\$513.20
B1HP121	539 10 45-29	BDP-10A-404, PG-1GQN-DY1X-XXXX	Pump	--	--	ST	\$398.00

### Hustler

Product No.	OEM No.	Hydro-Gear No.	Type	Side	Application	Code*	Price
B1HP600	600976, 768341	52114	Filter	--	Fits Hydro-Gear Transmission models ZT-2800, 3100, 3400, G700	ST	\$10.70
B1HP113	453166, 781047	BDP-10A-400, PG-1HQQ-DY1X-XXXX	Pump	--	Z	ST	\$398.00
B1HP216	601133	PJ-3KCC-GY1C-XXXX, PK-3KCC-GY1C-XXXX	Pump	RH	Z, Z4	DS	\$549.00
B1HP208	768226	BDP-10L-137P, PL-BGRR-DY1X-XXXX	Pump	Both	Walk-Behinds	DS	\$548.90
B1HP128	781047	BDP-10A-418, PG-1HCC-DY1X-XXXX	Pump	LH	Mini Z, Z, Z XR7	ST	\$426.80
B1HP109	781062	BDP-10A-300, PG-1KQQ-DY1X-XXXX	Pump	--	Z	ST	\$462.80
B1HP110	781062	BDP-10A-316, PG-1KCC-DY1X-XXXX	Pump	--	--	ST	\$426.80
B1HP119	788042	BDP-21L-418, PW-1LCC-EY1X-XXXX	Pump	--	ATZ	ST	\$515.70
B1HP307	788067	311-2600L	Transaxle	LH	FasTrak	DS	\$915.70

### Hydro-Gear

Product No.	OEM No.	Hydro-Gear No.	Type	Side	Application	Code*	Price
B1HP600	--	52114	Filter	--	Fits Hydro-Gear Transmission models ZT-2800, 3100, 3400, G700	ST	\$10.70
B1HP601	--	51563	Filter	--	Fits Hydro-Gear filter Fits Hydro-Gear 210-3000	ST	\$10.60
B170661	--	70661	Pump Test Kit	--	--	ST	\$613.50

### John Deere

Product No.	OEM No.	Hydro-Gear No.	Type	Side	Application	Code*	Price
B1HP132	D28227	BDP-10A-101, PG-1DQP-DY1X-XXXX	Pump	LH	717, 727	DS	\$418.00
B1HP115	TCA10020	BDP-10L-117, PL-BGQQ-DY1X-XXXX	Pump	--	M653, M655, M665	ST	\$513.20
B1HP130	TCA12525	BDP-10A-411, PG-4HQN-DY1X-XXXX	Pump	--	737, 757 Z-Trak	ST	\$398.00
B1HP149	TCA14668	BDP-10A-324, PG-1KRA-DY1X-XXXX	Pump	RH	647, 657, 667	DS	\$432.40
B1HP150	TCA14669	BDP-10A-447, PG-1HRA-DY1X-XXXX	Pump	LH	647, 657, 667	DS	\$432.40
B1HP171	TCA14965	BDP-10A-452, PG-1HRA-DA1X-XXXX	Pump	LH	WH36A, WH48A, WH52A	DS	\$457.30
B1HP135	TCA4966	BDP-10A-329, PG-1KRA-DB1X-XXXX	Pump	RH	WH36A, WH48A, WH52A	DS	\$451.30

### Kees

Product No.	OEM No.	Hydro-Gear No.	Type	Side	Application	Code*	Price
B1HP115	101111	BDP-10L-117, PL-BGQQ-DY1X-XXXX	Pump	--	--	ST	\$513.20

### Lastec

Product No.	OEM No.	Hydro-Gear No.	Type	Side	Application	Code*	Price
B1HP191	26453	BDP-10A-327, PG-3KCC-NB12-XXXX	Pump	RH	Zero Turn	DS	\$533.40
B1HP188	26462	BDP-10A-451, PG-3HCC-NA12-XXXX	Pump	LH	Zero Turn	DS	\$533.40

**Lesco**

Product No.	OEM No.	Hydro-Gear No.	Type	Side	Application	Code*	Price
B1HP115	24090	BDP-10L-117, PL-BGQQ-DY1X-XXXX	Pump	--	--	ST	\$513.20

**MTD**

Product No.	OEM No.	Hydro-Gear No.	Type	Side	Application	Code*	Price
B1HP303	618-04431A	ZC-DMBB-4DDC-2RPX	Transaxle	LH	MTD Gold RZT	ST	\$519.80

**Scag**

Product No.	OEM No.	Hydro-Gear No.	Type	Side	Application	Code*	Price
B1HP600	HG521114	52114	Filter	--	Fits Hydro-Gear Transmission models ZT-2800, 3100, 3400, G700	ST	\$10.70
B1HP215	482696	BDP-16A-307, PR-1JBC-EY1X-XXXX	Pump	RH	Turf Tiger	DS	\$512.40
B1HP105	391456, 483097	BDP-10A-305, PG-1JQQ-DY1X-XXXX	Pump	RH	SWZ, SWZU	ST	\$398.00
B1HP115	46360, 48436, 48551	BDP-10L-117, PL-BGQQ-DY1X-XXXX	Pump	--	SWZ, SWZU, Tiger Cub, Turf Tiger	ST	\$513.20
B1HP139	482325	BDP-10A-364, BDP-10A-366, PG-1JPC-DY1X-XXXX	Pump	LH	Turf Tiger	DS	\$432.40
B1HP176	482325	BDP-10A-330, PG-1KAN-DY1X-XXXX	Pump	LH	Turf Tiger	DS	\$432.40
B1HP157	482326	BDP-10A-430, PG-1HAN-DY1X-XXXX	Pump	RH	Turf Tiger	DS	\$432.40
B1HP165	482326	BDP-10A-464, BDP-10A-466, PG-1HPC-DY1X-XXXX	Pump	RH	Turf Tiger	DS	\$432.40
B1HP172	282326, 482512, 482638	BDP-10A-317, PG-1JBC-DY1X-XXXX	Pump	RH	Turf Tiger	DS	\$446.90
B1HP117	482637, 482511, 482325	BDP-10A-429, PG-1HBC-DY1X-XXXX	Pump	LH	Turf Tiger	ST	\$426.80
B1HP110	482643	BDP-10A-316, PG-1KCC-DY1X-XXXX	Pump	LH	Tiger Cub, Wildcat	ST	\$426.80
B1HP114	482644	BDP-10A-419, PG-1GCC-DY1X-XXXX	Pump	RH	Tiger Cub, Wildcat	ST	\$426.80
B1HP120	482695	BDP-16A-410, PR-1HBC-EY1X-XXXX	Pump	LH	Turf Tiger	DS	\$512.40
B1HP111	483098	BDP-10LA-437, PG-1GQQ-DY1X-XXXX	Pump	LH	SWZ, SWZU	ST	\$398.00
B1HP127	48784	BDU-10L-216	Transmission	--	SSZ	ST	\$546.40
B1HP300	483190	HGM-15E-3138	Wheel Motor	--	Tiger Cub, Turf Tiger, Wildcat, Z Cat	ST	\$662.50

**Snapper**

Product No.	OEM No.	Hydro-Gear No.	Type	Side	Application	Code*	Price
B1HP115	2-7127, 7027127	BDP-10L-117, PL-BGQQ-DY1X-XXXX	Pump	--	--	ST	\$513.20
B1HP110	7011222	BDP-10A-316, PG-1KCC-DY1X-XXXX	Pump	--	--	ST	\$426.80
B1HP128	7011223	BDP-10A-418, PG-1HCC-DY1X-XXXX	Pump	RH	Fits 36" and 48" walk-behind	ST	\$426.80
B1HP309	79816, 7062308, 7079816	BDU-10S-117	Transmission	RH	Fits 42" Z4202M	DS	\$627.60
B1HP134	7072521	BDP-10A-441, PG-3HCC-NE1X-XXXX	Pump	--	Mid-Mount Z	DS	\$514.00

## Hydrostatic Pumps and Motors

### Snapper

Product No.	OEM No.	Hydro-Gear No.	Type	Side	Application	Code*	Price
B1HP125	7075709, 75709	BDP-10A-331, PG-3KCC-NA1X-XXXX	Pump	LH	Snapper Pro 48", 52", 61" NZM19481KWV, KZM21523KWV, NZM25612KWV	DS	\$514.00
B1HP194	7075709, 75709	BDP-10A-314, PG-3KQQ-NA1X-XXXX	Pump	LH	Snapper Pro 48", 52", 61" NZM19481KWV, KZM21523KWV, NZM25612KWV	DS	\$485.20
B1HP190	7075710, 74737	BDP-10A-424, PG-3HQQ-NA1X-XXXX	Pump	--	Mid-Mount Z	DS	\$485.20
B1HP126	7075710, 75710	BDP-10A-454, PG-3HCC-NA1X-XXXX	Pump	RH	Snapper Pro 48", 52", 61" NZM19481KWV, KZM21523KWV, NZM25612KWV	DS	\$514.00
B1HP305	7075638	HGM-15E-3051	Wheel Motor	RH	Mid-Mount Z	ST	\$658.20
B1HP308	5023091, 7046255	HGM-12P-7172	Wheel Motor	--	Walk-behind, Z	DS	\$449.30

### Toro

Product No.	OEM No.	Hydro-Gear No.	Type	Side	Application	Code*	Price
B1HP600	109-3321	52114	Filter	--	Fits Hydro-Gear Transmission models ZT-2800, 3100, 3400, G700	ST	\$10.70
B1HP106	103-1942	BDP-10A-414, PG-1GNP-DY1X-XXXX	Pump	--	--	ST	\$398.00
B1HP104	103-4040	BDP-10A-450, PG-1GEF-DY1X-XXXX	Pump	--	--	ST	\$426.80
B1HP111	103-4247, 106-5490, 109-4988	BDP-10A-437, PG-1GQQ-DY1X-XXXX	Pump	--	--	ST	\$398.00
B1HP113	104-1167	BDP-10A-400, PG-1HQQ-DY1X-XXXX	Pump	--	--	ST	\$398.00
B1HP181	104-7750	BDP-10A-304, PG-1KNQ-DY1X-XXXX	Pump	--	--	DS	\$418.00
B1HP148	104-7751	BDP-10A-405, PG-1HNQ-DY1X-XXXX	Pump	--	--	DS	\$418.00
B1HP109	106-5489, 112-8717	BDP-10A-300, PG-1KQQ-DY1X-XXXX	Pump	--	--	ST	\$398.00
B1HP162	106-9471	BDP-10A-453, PG-1HEE-DY2X-XXXX	Pump	--	--	DS	\$446.90
B1HP122	110-4150	PG-AGNP-DY1X-XXXX	Pump	--	Z500	ST	\$398.00
B1HP169	114-3400	BDP-10A-438, PG-1HQQ-BD1X-XXXX	Pump	--	--	DS	\$436.90
B1HP184	114-3401	BDP-10A-323, PG-1KQQ-DB1X-XXXX	Pump	--	--	DS	\$436.90
B1HP210	82-8220	BDP-10L-118P, PL-BGVV-DY2X-XXXX	Pump	--	--	DS	\$533.30
B1HP207	95-1538	BDP-10L-130P, PL-BGQQ-DYZX-XXXX	Pump	Both	Proline Walk-Behind	DS	\$557.70
B1HP136	98-4374	BDP-10L-119, PL-BGVV-DY1X-XXXX	Pump	--	--	DS	\$533.30
B1HP116	98-4375	BDP-10L-121, PL-BGVQ-DY1X-XXXX	Pump	--	--	ST	\$520.60











### Wright Manufacturing









Product No.	OEM No.	Hydro-Gear No.	Type	Side	Application	Code*	Price
B1HP115	31490001	BDP-10L-117, PL-BGQQ-DY1X-XXXX	Pump	Both	Fits 36", 42", 48", 52" and 61" Stander models	ST	\$513.20
B1HP124	31490009	PR-1KCC-EH1X-XXXX	Pump	RH	Fits 48", 52", and 61" Sentar models	ST	\$511.20
B1HP305	32410005	HGM-15E-3051	Wheel Motor	RH	Sentar II, Sentar III, Z	ST	\$658.20
B1HP308	32410004	HGM-12P-7172	Wheel Motor	--	Sport, Stander	DS	\$449.30

	Bearing #	ID	OD	Height	Flange OD	Material	Oregon	Rotary	Stens	Price	
<b>Ariens</b>											
	<b>B1SB487</b> <b>05406300</b> - Ball Bearing. Sealed high speed bearing for snow-throwers; Ariens model 59063.	SC0493LU	3/4"	1-3/4"	1/2"	--	--	45-035	487	230-045	\$17.00
	<b>B1MT61</b> <b>05408000</b> - Ball Bearing. Fits model 824 snow-throwers.	1621-2RS	1/2"	1-3/8"	7/16"	--	--	--	8869	230-276	\$3.80
	<b>B1AC61</b> <b>05418800</b> - Ball Bearing. Fits 93700 series snow-throwers.	6203-ZZ	17 mm	40 mm	12 mm	--	--	45-624	7917	230-060	\$2.30
	<b>B1RS46</b> <b>05418800</b> - Ball Bearing. Fits 93700 series snow-throwers.	6203-2RS	17 mm	40 mm	12 mm	--	--	--	8507	230-060	\$3.20
	<b>B1SB483</b> <b>05418800</b> - Ball Bearing. Fits 93700 series snow-throwers.	6203-2RS	5/8"	1-9/16"	15/32"	--	--	45-203	483	230-11	\$3.20
	<b>B1SB1265</b> <b>05403900, 05435100</b> - Ball Bearing. Fits 24" and 32" snow-throwers drive train attachments.	99502H-RST	5/8"	1-3/8"	7/16"	--	--	45-202	1265	230-019	\$4.00
	<b>B1SB484</b> <b>05407300, 05412000</b> - Ball Bearing. Fits Emperor 6-10 HP, and 48" snow-throwers.	Z9504-RSR	19.05 mm	45.225 mm	15.494 mm	--	--	45-402	484	230-160	\$3.60
	<b>B1SB813</b> <b>05404400, 05404500</b> - Roller Bearing. Fits FT524, RT214, RT424, RT5020, ST424, ST624, ST724, ST732, ST1032, ST1124, ST1152, YT1138, and YT1238 mowers, tillers and snow-throwers. Includes race.	LM11949/10	3/4"	1.1781"	0.61"	--	--	45-206	813	230-929	\$4.90
	<b>B1SB814</b> <b>05407000, 05406900</b> - Roller Bearing. Fits tillers, snow-throwers, and PM34 and Zoom mowers. Includes race.	L44643/10	1"	1.98"	0.56"	--	--	45-002	814	215-285	\$5.40
	<b>B1SB8796</b> <b>05503000</b> - Bushing. Axle bushing for snow-thrower models 824, 910, and 924	--	7/8"	1"	5/8"	1-1/4"	--	45-013	8796	225-862	\$2.20
	<b>B1SB8783</b> <b>05521300, 05521600</b> - Bushing. Hex-shaped bushing for newer snow-thrower models ST-524 and ST-724. Oil Impregnated.	--	3/4"	7/8"	21/32"	1-3/16"	Iron	--	8783	225-763	\$2.20







Snow Thrower Parts

	Bearing #	ID	OD	Height	Flange OD	Material	Oregon	Rotary	Stens	Price	
<b>Ariens</b>											
	<b>B1SB8446</b> <b>05503500</b> - Flanged Bushing. Auger side bushing for all snow-thrower models 1960 to present. Oil impregnated.	--	1"	1-1/8"	5/8"	--	Bronze	45-006	8446	225-839	\$3.90
	<b>B1AC226</b> <b>05503900</b> - Flanged Bushing. Fits 832 and 1032 snow-thrower attachment scoops.	--	3/4"	1"	5/8"	--	--	45-007	8445	225-854	\$4.20
<b>Husqvarna</b>											
	<b>B1MT61</b> <b>606 00 01-84</b> - Ball Bearing. Fits models 824 snow-throwers.	1621-2RS	1/2"	1-3/8"	7/16"	--	--	--	8869	230-276	\$3.80
<b>Jacobsen</b>											
	<b>B1SB8783</b> <b>53836</b> - Bushing. Hex-shaped bushing for newer snow-thrower models. Oil impregnated.	--	3/4"	7/8"	21/32"	1-3/16"	Iron	--	8783	225-763	\$2.40
<b>John Deere</b>											
	<b>B1MT61</b> <b>AM122108</b> - Ball Bearing. Fits 524D, 724D, 826D, 828D, and 1032D walk-behind snow-throwers.	1621-2RS	1/2"	1-3/8"	7/16"	--	--	--	8869	230-276	\$3.80
	<b>B1SB6535</b> <b>AM122158</b> - Ball Bearing. Fits model 542D, 742D, 826D, 828D, 924DE, 1032D, 1128DE, 1128DDE, and 1332DDE walk-behind snow-throwers.	6203-2RS	3/4"	1-9/16"	15/32"	--	--	45-005	6535	230-052	\$2.50
	<b>B1SB484</b> <b>JD9239, JD9296</b> - Ball Bearing. Fits model 3700 mower and models 520, 522, and 524 snow-throwers.	Z9504-RST	19.05 mm	45.225 mm	15.494 mm	--	--	12-402	484	230-160	\$3.60
	<b>B1AC229</b> <b>M63810, M88251</b> - Ball Bearing. Fits 160, 260, 261, and 272 rotary mowers. Fits 359 snow-throwers. Fits 400 series 60" and 900 series 72" mid-mount mowers.	6205-2RS	31/32"	2-1/32"	19/32"	--	--	--	7162	230-102	\$3.80
	<b>B1SB814</b> <b>JD8253, JD8933</b> - Roller Bearing. Fits 46"-50" snow-throwers; 303, 305, and 1500 model tillers.	L44643/10	Includes race.								
			1"	1.98"	0.56"	--	--	45-002	814	215-285	\$5.40
	<b>B1SB8783</b> <b>M127093</b> - Bushing. Hex-shaped bushing for newer snow-thrower models. Oil impregnated.	--	3/4"	7/8"	21/32"	1-3/16"	Iron	--	8783	225-763	\$2.20

	Bearing #	ID	OD	Height	Flange OD	Material	Oregon	Rotary	Stens	Price	
<b>John Deere</b>											
	<b>B1SB8446</b> <b>M124417</b> - Flanged Bushing. Fits 828D, 924DE, 1032D, 1128DDE, 1128DE, and 1332DDE walk-behind snow-throwers. Oil impregnated.	--	1"	1-1/8"	5/8"	--	Bronze	45-006	8446	225-839	\$3.90
	<b>B1AC226</b> <b>M127082</b> - Flanged Bushing. Fits 524D, 724D, and 826D walk-behind snow-throwers.	--	3/4"	1"	5/8"	--	--	45-007	8445	225-854	\$4.20
<b>MTD</b>											
	<b>B1MT29</b> <b>941-0309</b> - Ball Bearing. Auger impeller bearing. Fits 22" and 40" snow-throwers. Includes collar.	SA204-12	3/4"	1-55/64"	27/32"	--	--	--	10265	--	\$7.80
	<b>B1SB3200</b> <b>741-0199, 941-0199</b> - Bushing. Wheel bushing. Fits 311-100A, 311-430A, 311-600A models and 450, 550, and 580 snow-throwers.	--	3/4"	1-1/4"	3/4"	1-3/8"	Nylon	45-082	3200	225-235	\$2.90
	<b>B1SB3211</b> <b>741-0293, 748-0143, 941-0293</b> - Flanged Bushing. Fits 440, 450, 550, 552, 586, and 588 (1987-1988) series snow-throwers and 300, 400 and 500 series lawn tractors.	--	3/4"	1"	3/4"	1-1/4"	Nylon	45-092	3211	225-144	\$3.90
	<b>B1MT18</b> <b>741-0313, 741-0487, 741-0487A, 741-0487C, 941-0487A</b> - Flanged Bushing. Order in multiples of 10.	--	5/8"	13/16"	1-1/8"	--	Nylon	45-095	7720	225-750	\$2.40
	<b>B1SB3201</b> <b>748-0184</b> - Flanged Bushing. Fits 440, 450, 550, 552, 586, 588, 840, 841, and 850 snow-throwers and 375, 380, 405, and 410 tillers.	--	5/8"	3/4"	3/4"	1-1/8"	Bronze	45-089	3201	225-110	\$2.80
<b>Noma</b>											
	<b>B1SB8783</b> <b>53836</b> - Bushing. Hex-shaped bushing for newer snow-thrower models. Oil impregnated.	--	3/4"	7/8"	21/32"	1-3/16"	Iron	--	8783	225-763	\$2.20
<b>Toro</b>											
	<b>B1SB487</b> <b>101480</b> - Ball Bearing. Sealed high speed bearing for snow-throwers.	SCO493LU	3/4"	1-3/4"	1/2"	--	--	45-035	487	230-045	\$17.00
	<b>B1SB483</b> <b>112-0423, 38-7820</b> - Ball Bearing. Fits S-200, S-620, and CCR snow-throwers.	6203-2RS	5/8"	1-9/16"	15/32"	--	--	45-203	483	230-011	\$3.20

Snow Thrower Parts

	Bearing #	ID	OD	Height	Flange OD	Material	Oregon	Rotary	Stens	Price
<b>Toro</b>										
	<b>B1AC61</b> <b>112-0423, 38-7820</b> - Ball Bearing. Shaft bearing for S200 snow-throwers.									
	6203-ZZ	17 mm	40 mm	12 mm	--	--	45-624	7917	230-060	\$2.30
	<b>B1RS46</b> <b>112-0423, 38-7820</b> - Ball Bearing. Shaft bearing for S200 snow-throwers.									
	6203-2RS	17 mm	40 mm	12 mm	--	--	--	8507	230-060	\$3.20
<b>Troy Bilt</b>										
	<b>B1AC61</b> <b>1120502, 1185064, 941-0124</b> - Ball Bearing. Fits S-200, S-620, and CCR snow-throwers.									
	6203-ZZ	17 mm	40 mm	12 mm	--	--	45-624	7917	230-060	\$2.30
	<b>B1RS46</b> <b>1120502, 1185064, 941-0124</b> - Ball Bearing. Fits S-200, S620, and CCR snow-throwers.									
	6203-2RS	17 mm	40 mm	12 mm	--	--	--	8507	230-060	\$3.20

### Spray-PRO Liquid Sprayer

The Spray-PRO is a revolutionary new product designed to take the work out of spraying your lawn, sidewalk, driveways, paths, and gardens in spring, summer, fall, and for winter ice control. With a spray width of 3' - 5' and up to a 13,000 sq.ft. coverage, the B1EWS25 will make quick work when spraying herbicides, pesticides, fungicides, liquid ice control products, or fertilizers. Our 2-mode valve allows for either Transport or Spray operation and is selected high on the handle. While in Transport mode, the B1EWS25 pump continues to operate agitating the material in the tank for a desired mixture. The B1EWS25 includes three different nozzle tips of fine, medium, and coarse, for controlling your application rates within your spray coverage. The B1EWS25 has a 6.6 gallon capacity self-agitating tank and does the job of several tank sprayers and without the pain of carrying them in hand or on your back. The B1EWS25 has a ground driven pump, no battery, operates at walking speed, and pushes no harder than a small spreader. Designed for commercial use, this sprayer will perform under daily use by contractors, as well as the occasional use of the homeowner with equal results.

6.6 gal/25liter Tank capacity with coverage from 6,600 - 13,000 square feet \*

- New Mark II Ground driven pump
- Self-Agitating Tank
- 13" stud type pneumatic tires on rustproof poly rims
- No load pull-back system
- Heavy-duty epoxy powder coated "Diamond" chassis
- 3-position height adjustable handles for comfortable use
- 2-mode valve for spray or transport
- Easy to push high-speed gearbox
- 5-Year limited warranty

**B1EWS25**      \$488.30



Product No.	OEM No.	Type	Section	Dimensions	Description	Cross Reference	Price
<b>Ariens</b>							
<b>B1SB8762</b>	7203200	Raw Edge	--	1/4" x 27-5/32"	Fits models 1975-1978 & Sno-Tro model. Drive belt 4&5 HP, 1969-1974 models 922018, 922019, 922020 & 922021. Sold in matching pairs.	Oregon:-- Rotary:9726 Stens:--	\$1.80
<b>B1SB8430</b>	7206600	Raw Edge	--	3/8" x 34"	Traction drive belt. Fits snow thrower models 924024, 924025, 924034, 924035, 924080, 924082,, 924084, 924085, 924086, 924087, 8-12 HP engines.	Oregon:75-104 Rotary:-- Stens:265-999	\$5.00
<b>B1G6734</b>	7210700	Covered	3L340	3/8" x34"	Snow thrower drive belt.	Oregon:75-334 Rotary:7439 Stens:238-034	\$5.00
<b>B1G6735</b>	7211200	Covered	3L350	3/8" x 35"	Snow thrower drive belt.	Oregon:75-335 Rotary:7440 Stens:238-035	\$5.10
<b>B1SB8432</b>	7204700	Cogged	--	3/8" x 35-1/2"	Fits older Ariens snow thrower with single belt. Fits model ST724, ST732, ST524, ST624, ST824 tractors.	Oregon:75-098, 75-365 Rotary: - Stens:265-504	\$6.20
<b>B1G6826</b>	7206000	Covered	4L260-A24	1/2" x 26"	Snow thrower drive belt.	Oregon:75-426 Rotary:7469 Stens:248-026	\$3.00
<b>B1G6828</b>	7206000	--	4L280-A26	1/2" x 28"	--	Oregon:75-428 Rotary:7471 Stens:248-028	\$3.00
<b>B1G6831</b>	7213700	Covered	4L310-A29	1/2" x 31"	Snow thrower drive belt.	Oregon:75-431 Rotary:7474 Stens:248-031	\$3.40
<b>B1G6834</b>	7211100	Covered	4L340-A32	1/2" x 34"	Snow thrower drive belt.	Oregon:75-434 Rotary:7477 Stens:248-034	\$3.90
<b>B1SB8425</b>	7211400	Raw Edge	--	1/2" x 34-3/4"	Auger drive belt. Fits models 932011. 932004. 932006. 932007. 932016. 932025. 932030. 932102. 932103. 932310. 932400. 932500.	Oregon:75-084 Rotary:-- Stens:265-914	\$8.00
<b>B1G6836</b>	7203800	--	4L360-A34	1/2" x 36"	--	Oregon:75-436 Rotary:7479 Stens:248-036	\$4.10
<b>B1SB8431</b>	7208600	Raw Edge	--	1/2" x 40"	Auger drive belt. Fits snow thrower model 924082, 8 HP engines.	Oregon:75-117 Rotary:-- Stens:265-987	\$13.00
<b>B1G6847</b>	7211800	Covered	4L470-A45	1/2" x 47"	Snow thrower drive belt.	Oregon:75-447 Rotary:7490 Stens:248-047	\$5.00
<b>B1G6850</b>	7209600	Covered	4L500-A48	1/2" x 50"	Snow thrower drive belt.	Oregon:75-450 Rotary:7493 Stens:248-050	\$6.00
<b>B1G6851</b>	7213600	Covered	4L510-A49	1/2" x 51"	Snow thrower drive belt.	Oregon:75-451 Rotary:7494 Stens:248-051	\$6.10
<b>B1G6852</b>	7212300	Covered	4L520-A50	1/2" x 52"	Snow thrower drive belt.	Oregon:75-452 Rotary:7495 Stens:248-052	\$6.00

Snow Thrower Belts

Product No.	OEM No.	Type	Section	Dimensions	Description	Cross Reference	Price
<b>Ariens</b>							
<b>B1G6858</b>	07210100, 07214800	Covered	4L580-A56	1/2" x 58"	Snow thrower drive belt.	Oregon:75-458 Rotary:7501 Stens:248-058	\$7.00
<b>B1G6868</b>	7213500	Covered	4L680-A66	1/2" x 68"	Snow thrower drive belt.	Oregon:75-468 Rotary:7511 Stens:248-068	\$8.00
<b>B1G6871</b>	7211600	Covered	4L710-A69	1/2" x 71"	Snow thrower drive belt.	Oregon:75-471 Rotary:7514 Stens:248-071	\$8.20
<b>B1G6872</b>	7212200	Covered	4L720-A70	1/2" x 72"	Snow thrower drive belt.	Oregon:75-472 Rotary:7515 Stens:248-072	\$8.30
<b>B1G6889</b>	7210300	Covered	4L890-A87	1/2" 89"	Snow thrower drive belt.	Oregon:75-489 Rotary:7532 Stens:248-089	\$10.80
<b>B1G6896</b>	7213900	Covered	4L960-A94	1/2" x 96"	Snow thrower drive belt.	Oregon:75-496 Rotary:7539 Stens:248-096	\$12.00
<b>B1G68109</b>	7212000	Covered	4L1090-A107	1/2" x 109"	Snow thrower drive belt.	Oregon:75-409 Rotary:7552 Stens:248-109	\$13.00

**John Deere**

<b>B1SB8432</b>	M41985	Cogged	--	3/8" x 35-1/2"	Fits older model snow thrower with single belt.	Oregon:75-098, 75-365 Rotary:-- Stens:265-504	\$3.50
<b>B1G6836</b>	M82612	--	4L360-A34	1/2" x36"	Fits snow thrower models TRS27, TRS32, TRX27, TRX32, 1032, 526, 726, 732, 826, and 832.	Oregon:75-436 Rotary:7479 Stens:248-036	\$4.00
<b>B1G6839</b>	PT10869	--	4L390-A37	1/2" x39"	Fits 321, 520, 824, 826T, 1026, and 1028 snow throwers.	Oregon:75-439 Rotary:7482 Stens:248-039	\$4.20
<b>B1SB8431</b>	M143796	Raw Edge	--	1/2" x 40"	Fits snow thrower models 1128DDE, 1128DE and 924DE.	Oregon:75-117 Rotary:-- Stens:265-987	\$13.00
<b>B1G6845</b>	PT10866	Covered	4L450-A43	1/2" x 45"	Fits 321, 520, 824, 826T, 1026, and 1028 snow throwers.	Oregon:75-445 Rotary:7488 Stens:248-045	\$5.00

**MTD**

<b>B1MT312</b>	954-04014	Cogged	--	3/8" x 27"	Fits compact snow throwers (2005 and newer)	Oregon:-- Rotary:-- Stens:265-245	\$9.50
<b>B1MT314</b>	954-0456	Covered	--	3/8" x 28-5/8"	Fits two-stage snow throwers (2005 and newer).	Oregon:-- Rotary:-- Stens:265-250	\$2.10
<b>B1MT316</b>	954-0367	--	--	3/8" x 34-1/2"	Auger drive belt. Fits models 140 and 181 single stage Snow throwers and augers years 1990-1996.	Oregon:75-157 Rotary:-- Stens:265-256	\$3.00

**MTD**

<b>B1MT346</b>	754-0430, 954-0430	Cogged	3VX350	3/8" x 35"	Fits MTD, Cub Cadet and White snow throwers. Two belt set.	Oregon:75-158 Rotary:12429 Stens:265-811	\$4.50
<b>B1MT88</b>	954-0101A, 754-0101A	Covered	--	1/2" x 35"	Fits Snow thrower model 721	Oregon:75-148 Rotary:10089 Stens:265-433	\$4.50

Product No.	OEM No.	Type	Section	Dimensions	Description	Cross Reference	Price
<b>Simplicity</b>							
<b>B158392</b>	1663885, 1663885SM	Ribbed	--	9/16" x 34"	Fits Snowbuster 220.	Oregon:75-066 Rotary:9861 Stens:265-478	\$7.00
<b>Toro/Wheel Horse</b>							
<b>B1TR30</b>	25-6430	Ribbed	--	3/32" x33"	Fits Snowmaster S200 and S620.	Oregon:75-451 Rotary:7952 Stens:265-678	\$6.50
<b>B1TR151</b>	71-5380, 71-5381	Raw Edge	--	3/8" x 34-1/2"	Drive belt. Fits model CCR 1000 snow throwers.	Oregon:75-192 Rotary:10090 Stens:265-809	\$3.00
<b>B158390</b>	26-9672	Raw Edge	--	1/2" x 30"	Fits most 2 stage snow t hrowers.	Oregon:-- Rotary:10210 Stens:--	\$24.00
<b>B158392</b>	55-9300	Ribbed	--	9/16" x 34"	Fits model CCR2000 snow thrower.	Oregon:75-066 Rotary:9861 Stens:265-478	\$7.00
<b>B158391</b>	26-9671	Raw Edge	--	1/2" x 36-5/16"	Fits snow thrower model 824. Laminated.	Oregon:-- Rotary:10746 Stens:--	\$24.00
<b>Troy Bilt</b>							
<b>B158392</b>	1737899	Ribbed	--	9/16" x 34"	Fits single stage snow throwers.	Oregon:75-066 Rotary:9861 Stens:265-478	\$7.00





Spindles

AYP



	OEM PART NO	TYPE	DESCRIPTION	CROSS REFERENCE	PRICE EACH
	174356	Assembly	Fits models with 48" decks. 4-bolt short housing. 5 point star center hole.	Oregon: 82-015 Rotary: 11014 Stens: 285-108	\$43.40
	174350	Housing	Housing for our B1AY15.	Oregon: -- Rotary: -- Stens: --	\$20.40
	174360	Shaft	Shaft for our B1AY15.	Oregon: -- Rotary: -- Stens: 192-333	\$19.40
	187292, 192870 532187290 532192870 539-112057	Assembly	Fits models with 54" decks. 4-bolt long housing. 5 point star center hole. Threaded mounting holes include bolts.	Oregon: 82-026 Rotary: 11590 Stens: --	\$39.40
	187281	Housing	Housing for our B1RS45	Oregon: -- Rotary: 11591 Stens: --	\$24.40
	187291	Shaft	Shaft for our B1RS45.	Oregon: 85-032 Rotary: 11592 Stens: 192-012	\$22.80
	143651	Assembly	Fits models with 44" and 50" decks. 3-bolt short. 5 point star center hole.	Oregon: -- Rotary: 9519 Stens: --	\$32.00
	137152	Housing	Housing for our B1AY25.	Oregon: -- Rotary: -- Stens: --	\$24.70
	137553	Shaft	Shaft for our B1AY25.	Oregon: -- Rotary: 9520 Stens: --	\$24.20
	130794	Assembly	Fits models with 36", 38", and 42" decks. 3-bolt long. 5 point star center hole.	Oregon: 82-225 Rotary: 8479 Stens: 285-456	\$28.70
	128774	Housing	Housing for B1RS25	Oregon: 82-220 Rotary: 8548 Stens: 285-441	\$16.70

## AYP



	OEM PART NO	TYPE	DESCRIPTION	CROSS REFERENCE	PRICE EACH
	137646 137645 133172	Shaft	Shaft for B1RS25.	Oregon: 85-017 Rotary: 8549 Stens: 285-468	\$20.00
	130794	Shaft	Heavy-duty version of B1RS25.	Oregon: 82-014 Rotary: -- Stens: 192-353	\$49.00
	101479X, 102050X 71275, 73558 101477X, 677A14 677A233, 677A181	Assembly	Height: 6-7/8", Pulley: 5-1/2", Saddle: 2-1/2"	Oregon: 82-677 Rotary: 1171 Stens: 285-213	\$50.40
	105891, 121687 121676, 100699 104926, 105722 109685	Assembly	Fits models with 38" and 44" decks. Height: 6-5/8", Pulley: 5-1/2", Saddle: 2-1/4".	Oregon: 82-678 Rotary: 6813 Stens: 285-031	\$54.20
	121617X 121657X	Assembly	Fits models 44" and 50" decks. Height: 5-3/8", Top Pulley: 5-1/4", Bottom Pulley: 4-1/4", Saddle: 2-1/4"	Oregon: 82-679 Rotary: 8649 Stens: 285-878	\$61.40
	121705X	Assembly	Fits models with 44" decks. Height: 6-1/2", Top Pulley: 4-7/8", Bottom Pulley: 4-1/4", Saddle: 2-1/4"	Oregon: 82-495 Rotary: 8647 Stens: 285-886	\$87.20
	136819	Assembly	Fits models with 44" and 50" decks. Height: 3-3/4", Pulley: 4-1/4", Saddle 2-1/4".	Oregon: 82-680 Rotary: 8648 Stens: 285-895	\$91.80
	17000612 17060612 17490612 817000612	Mounting Bolt	Fits our B1AM91, B1RS60, B1SB1171, B1SB8647, B1SB8649 spindle assemblies. Self-tapping. Package quantity: 10.	Oregon: 02-301 Rotary: 9373 Stens: 285-134	\$0.95
	138776 157722 173984	Mounting Bolt	Fits our B1AY25, B1RS25 and B1RS45 Spindle assemblies. Self-tapping. Package quantity: 10.	Oregon: -- Rotary: 9374 Stens: 285-040	\$0.95
	137266, 139729	Pulley Nut	Fits our B1AY25 and B1RS25 spindle assemblies.	Oregon: 04-001 Rotary: 8901 Stens: 285-476	\$3.40

Spindles





**BOBCAT**

	OEM PART NO	TYPE	DESCRIPTION	CROSS REFERENCE	PRICE EACH
	36006N	Assembly	Fits models with 32" and 36" decks. Short shaft.	Oregon: 82-306 Rotary: 1226 Stens: 285-809	\$125.00
	36082N	Assembly	Fits models with 48" decks. Long shaft.	Oregon: 82-307-0 Rotary: 1227 Stens: 285-940	\$117.00
	36567	Assembly	Fits XM series models with 36" and 48" decks.	Oregon: 82-320 Rotary: 9375 Stens: --	\$103.00

**BUNTON**

	OEM PART NO	TYPE	DESCRIPTION	CROSS REFERENCE	PRICE EACH
	1985145 PAL0806A PAL4606A PL6140A	Assembly	Fits 32", 36", 48", 52" and 61" walk-behind mowers.	Oregon: 82-315 Rotary: 8187 Stens: 285-217	\$125.00
	PL4607	Shaft	Shaft for our B1C078	Oregon: -- Rotary: 8188 Stens: --	\$17.50





**CUB CADET**

	OEM PART NO	TYPE	DESCRIPTION	CROSS REFERENCE	PRICE EACH
	618-04125, 618-04126 618-04126A, 918-04126 918-04126A	Assembly	Fits i1050, LT, SLT, and RZT mowers with 50" decks. "H" pattern center hole.	Oregon: 82-403 Rotary: 11962 Stens: --	\$73.00
	618-04129 618-04129A 918-04127 918-04129A 918-04129B	Assembly	Fits LT1000 series mowers with 50" decks. Round center hole.	Oregon: 82-412 Rotary: 11963 Stens: --	\$76.00
	618-3129, 618-3129A 618-3129B, 618-3129C 918-3129, 919-3129A 919-3129B, 919-3129C	Housing	Fits 2130, 2146, 2155, 2164 and 2166 models with 38", 42" and 44" decks.	Oregon: 82-411 Rotary: -- Stens: 285-107	\$49.00
	618-04636, 618-04636A 918-04636, 918-04363A 918-04363A 918-04865A	Assembly	LTX1045, LTX1046, Z-Force S with 46" decks. Includes pulley.	Oregon: -- Rotary: -- Stens: --	\$76.00





**CUB CADET**

	OEM PART NO	TYPE	DESCRIPTION	CROSS REFERENCE	PRICE EACH
	618-0624 618-0659 918-0624 918-0659	Assembly	Fits LT1040, LT1042, and RZT models with 42" cut decks and star hole blades.	Oregon: 82-408 Rotary: 12973 Stens: --	\$74.00

**DIXIE CHOPPER**

	OEM PART NO	TYPE	DESCRIPTION	CROSS REFERENCE	PRICE EACH
	10161	Assembly	Fits models with 50" and 60" decks with short shafts (outside spindle).	Oregon: 82-322 Rotary: 10178 Stens: --	\$109.00
	30217	Shaft	Shaft for our B1DC100.	Oregon: -- Rotary: 9949 Stens: 285-186	\$64.00
	10161-L	Assembly	Fits models with 50" and 60" decks with long shafts (inside spindle).	Oregon: 82-323 Rotary: 10179 Stens: --	\$109.00
	30217-L	Shaft	Shaft for our B1DC101.	Oregon: -- Rotary: 9950 Stens: 285-188	\$75.00

**ENCORE**





	OEM PART NO	TYPE	DESCRIPTION	CROSS REFERENCE	PRICE EACH
	363379	Assembly	Fits 32", 36", 48", 52", and 60" Premier PRO and Premier Hydro PRO models.	Oregon: 82-329 Rotary: 9749 Stens: --	\$77.00
	583106	Assembly	Fits 34", 42", 48", 52", 60" and 72" decks Prowler Frontcut, Prowler Midcut, Z and Z-Fusion.	Oregon: -- Rotary: 9750 Stens: --	\$77.00
	71460007	Assembly	Aluminum version of B1SC72	Oregon: 82-309 Rotary: 5722 Stens: 285-201	\$90.00
	71460007	Assembly	Cast iron version of our B1CO73	Oregon: 82-325 Rotary: 9153 Stens: 285-597	\$96.00
	363058	Shaft	Shaft for our B1CO73.	Oregon: 82-305 Rotary: 5999	\$24.00

## Spindles



### EVERRIDE

	OEM PART NO	TYPE	DESCRIPTION	CROSS REFERENCE	PRICE EACH
	200262	Assembly	Fits Scorpion FX models.	Oregon: 82-328 Rotary: 9754 Stens: 285-181	\$84.00

### EXMARK

	OEM PART NO	TYPE	DESCRIPTION	CROSS REFERENCE	PRICE EACH
	1-302030	Assembly	Fits 32", 36" and 48" walk-behind units. Outside spindles for 48" decks. Short shaft.	Oregon: 82-306 Rotary: 1226 Stens: 285-809	\$125.00
	1-402006	Assembly	Fits walk-behind models with 48" decks. Center spindle. Long shaft.	Oregon: 82-307-0 Rotary: 1227 Stens: 285-940	\$117.00
	1-634972	Assembly	Fits 60" Lazer Z.	Oregon: 82-318 Rotary: 10353 Stens: --	\$102.00
	103-1184	Assembly	Fits 52" Lazer Z HP.	Oregon: 82-346 Rotary: 10785 Stens: --	\$110.00
	103-3200 103-8075	Assembly	Fits 60" Lazer Z XP, XS and Turf Tracer Hydro.	Oregon: 82-347 Rotary: 10872 Stens: --	\$107.00



### FERRIS

	OEM PART NO	TYPE	DESCRIPTION	CROSS REFERENCE	PRICE EACH
	5030301	Assembly	Fits HydroWalk DD, HydroWalk SD, IS4000Z, IS5000Z, ProCut 30, and UltraBelt GD models with 32", 36", 48", 52", 61" and 72" decks.	Oregon: 82-309 Rotary: 5722 Stens: 285-201	\$88.00
	1541480	Shaft	Shaft for our B1CO73.	Oregon: 82-305 Rotary: 5999 Stens: --	\$24.00
	5030301	Assembly	Cast iron version of our B1CO73.	Oregon: 82-325 Rotary: 9153 Stens: 285-597	\$90.00

## GREAT DANE

	OEM PART NO	TYPE	DESCRIPTION	CROSS REFERENCE	PRICE EACH
	D18030 200041 200262	Assembly	Fits Chariot, Chariot JR., Gateway, Scamper, and Super Surfer models with 36", 48", and 52" decks.	Oregon: 82-328 Rotary: 9754 Stens: 285-181	\$84.00



## HUSQVARNA

	OEM PART NO	TYPE	DESCRIPTION	CROSS REFERENCE	PRICE EACH
	532 14 36-51	Assembly	Fits models with 44", 46" and 50" decks. 3-bolt short. 5 point star center hole.	Oregon: -- Rotary: 9519 Stens: 192-653	\$32.00
	532 13 71-52	Housing	Housing for our B1AY25.	Oregon: -- Rotary: --	\$25.70
	532 13 75-53	Shaft	Shaft for our B1AY25.	Oregon: -- Rotary: 9520 Stens: --	\$25.10
	532 13 07-94	Assembly	Fits models with 36", 38" and 42" decks. 3-bolt long. 5 point star center hole.	Oregon: 82-225 Rotary: 8479 Stens: 285-456	\$28.60
	532 12 87-74	Housing	Housing for our B1RS25.	Oregon: 82-220 Rotary: 8548 Stens: 285-441	\$17.40
	532 13 76-46	Shaft	Shaft for our B1RS25.	Oregon: 85-017 Rotary: 8549 Stens: 285-468	\$21.00
	532 13 07-49	Assembly	Heavy-duty version of B1RS25.	Oregon: 82-014 Rotary: -- Stens: 192-353	\$54.00
	532-10-14-77	Assembly	Height: 6-7/8", Pulley: 5-1/2" Saddle: 2-1/2".	Oregon: 82-677 Rotary: 1171 Stens: 285-213	\$60.00
	532 12 16-87	Assembly	Fits models with 38" and 44" decks Height: 6-5/8", Pulley: 5-1/2" Saddle: 2-1/4".	Rotary: 6813 Stens: 285-031	\$59.00
	817 06 06-12	Mounting Bolt	Fits our B1AM91, B1RS60, B1SB1171, B1SB8647, and B1SB8649 spindle assemblies. Self-tapping. Package quantity: 10. 3/8" - 16, 3/4 thread length.	Oregon: 02-301 Rotary: 9373 Stens: 285-134	\$0.95





Spindles



**HUSQVARNA**

	OEM PART NO	TYPE	DESCRIPTION	CROSS REFERENCE	PRICE EACH
	532 13 87-76 532 15 77-22 532 17 39-84	Mounting Bolt	Fits our B1AY25, B1RS25 and B1RS45 spindle assemblies. Self-tapping Package quantity: 10, 5/16" - 18, 1-1/4" thread lengths.	Oregon: -- Rotary: 9374 Stens: 285-040	\$0.95
	532 13 72-66 532 13 97-29	Pulley Nut	Fits our B1AY25 and B1RS25 spindle assemblies.	Oregon: 04-001 Rotary: 8901 Stens: 285-476	\$3.50



**HUSTLER**

	OEM PART NO	TYPE	DESCRIPTION	CROSS REFERENCE	PRICE EACH
	350595	Assembly	Fits Super Z models with 52", 60" and 72" decks.	Oregon: 82-021 Rotary: 12241 Stens: --	\$93.00
	783506	Assembly	Fits FasTrak, Mini Z, and Super Mini Z.	Oregon: -- Rotary: 11452 Stens: --	\$86.00
	796235	Assembly	Fits Super Z models with 52", 60" and 72" decks.	Oregon: -- Rotary: 12459 Stens: --	\$86.00





**JACOBSEN**

	OEM PART NO	TYPE	DESCRIPTION	CROSS REFERENCE	PRICE EACH
	552188	Assembly	Fits models with 32" and 36" decks. Short shaft.	Oregon: 82-306 Rotary: 1226 Stens: 285-809	\$120.00
	552312	Assembly	Fits models with 48" decks. Long shaft.	Oregon: 82-307-0 Rotary: 1227 Stens: 285-940	\$122.00



**JOHN DEERE**

	OEM PART NO	TYPE	DESCRIPTION	CROSS REFERENCE	PRICE EACH
	AM108925	Assembly	Fits 100, LX100, 200, and GT200 mowers with 38" decks. Fits F500 mowers with 48" decks.	Oregon: 82-332 Rotary: 11274 Stens: --	\$96.00
	AM121342	Assembly	Fits 100, LX100, F500, GT200, RX and SX series mowers with 38" and 48" decks.	Oregon: 82-333 Rotary: 11278 Stens: --	\$68.00

## JOHN DEERE

	OEM PART NO	TYPE	DESCRIPTION	CROSS REFERENCE	PRICE EACH
	AM106236 AM122797 PT8633	Assembly	Fits 32", 36", 48", 52" and 61" walk-behind mowers.	Oregon: 82-315 Rotary: 8187 Stens: 285-217	\$129.00
	PT8763	Shaft	Shaft for our B1CO78.	Oregon: -- Rotary: 8188 Stens: --	\$18.20
	AM124511	Assembly	Fits STX38 and STX46 models with 38" and 46" decks.	Oregon: 82-354 Rotary: -- Stens: --	\$50.00
	M149625, GX20962 GX21694, GY20454 GY21694	Assembly	Fits 102, 105, 115, 125, 135, 145, 155C, 190C, D100, D110, D120, D130, D140, D150, D160, D170, G110, LA100, LA105, LA110, LA115 LA120, LA125, LA130, LA135, LA140, LA145 LA150, LA155, LA165, LA175, X110, X120, X125, X130R, X140, X145, X155R, X165 X300, X300R, X304, Z225, and Z245 with 42", 48", and 54" decks. 7 lobe center hole.	Oregon: 82-359 Rotary: 12910 Stens: --	\$41.00
	GY20050 GY20785	Assembly	Fits L100 series mowers with 42" and 48" decks. Includes grease fitting.	Oregon: 82-356 Rotary: 11206 Stens: 285-093	\$44.00
	GX20234	Mounting Bolt	Self-tapping spindle mounting bolts. Package quantity: 12.	Oregon: -- Rotary: -- Stens: --	\$0.67

## KEES

	OEM PART NO	TYPE	DESCRIPTION	CROSS REFERENCE	PRICE EACH
	362024 101455	Assembly	Fits models with 32" and 36" decks. Short shaft.	Oregon: 82-306 Rotary: 1226 Stens: 285-809	\$120.00
	482005 101446	Assembly	Fits models with 48" decks. Long shaft.	Oregon: 82-307-0 Rotary: 1227 Stens: 285-940	\$121.00

## LAWN BOY

	OEM PART NO	TYPE	DESCRIPTION	CROSS REFERENCE	PRICE EACH
	112-0460	Assembly	Fits LT1040, LT1042, and RZT models with 42" cut decks and star hole blades.	Oregon: 82-408 Rotary: 12973 Stens: --	\$76.00

Spindles

**LAWN CHIEF**

	OEM PART NO	TYPE	DESCRIPTION	CROSS REFERENCE	PRICE EACH
	15891	Assembly	Fits Lawn Chief model #1239. Height: 6-5/8", Pulley: 5-1/2", Saddle: 2".	Oregon: 82-493 Rotary: 1172 Stens: 285-221	\$50.00

**LESCO**

	OEM PART NO	TYPE	DESCRIPTION	CROSS REFERENCE	PRICE EACH
	050164	Assembly	Fits several models.	Oregon: 82-306 Rotary: 1226 Stens: 285-809	\$129.00

**MTD**



	OEM PART NO	TYPE	DESCRIPTION	CROSS REFERENCE	PRICE EACH
	618-04636 618-04636A, 918-04636 918-04363A 918-04865A	Assembly	LTX1045, LTX1046 with 46" decks. Includes pulley.	Oregon: -- Rotary: -- Stens: --	\$76.00
	618-0111 618-0116 918-0116	Assembly	Fits 600 series and 800 series (RH and center) models with 46" decks. 6 point star center hole.	Oregon: 85-512 Rotary: 9284 Stens: 285-116	\$54.00
	--	Shaft	Shaft for our B1MT52.	Oregon: 85-046 Rotary: 9515 Stens: 285-336	\$18.00
	618-0112 618-0117 918-0117	Assembly	Fits 800 series models (LH) with 46" cut decks. 6 point star center hole.	Oregon: 82-511 Rotary: 9285 Stens: 285-117	\$74.00
	--	Housing	Housing for our B1MT51, B1MT54 and B1MT55.	Oregon: -- Rotary: -- Stens: --	\$41.50
	--	Shaft	Shaft for our B1MT51.	Oregon: -- Rotary: 9516 Stens: --	\$18.00
	618-0138 618-0142 918-0138 918-0142	Assembly	Fits 600 series mowers with 38" and 42" decks and star shaped housing. 6 point star center hole.	Oregon: 82-513-2 Rotary: 9288 Stens: 285-119	\$52.00
	--	Housing	Housing for our B1MT53.	Oregon: -- Rotary: -- Stens: --	\$43.00

MTD

	OEM PART NO	TYPE	DESCRIPTION	CROSS REFERENCE	PRICE EACH
	--	Shaft	Shaft for our B1MT53.	Oregon: 85-048 Rotary: 9517 Stens: --	\$19.00
	618-0241 618-0431 918-0241 918-0431	Assembly	Fits LH Spindles on 600 and 800 series mowers with 46" decks. 6 point center hole.	Oregon: 82-516 Rotary: 9287 Stens: 285-112	\$58.00
	618-0240 618-0430 918-0240 918-0430	Assembly	Fits RH and center spindles on 600 and 800 series mowers with 46" decks 6 point star center hole.	Oregon: 82-515 Rotary: 9286 Stens: 285-113	\$56.00
	--	Shaft	Shaft for our B1MT54.	Oregon: 85-049 Rotary: 9518 Stens: --	\$18.00
	618-0574 618-0656 918-0574	Assembly	Fits newer 600 series mowers with 36" and 42" decks. 6 point star center hole.	Oregon: 82-517 Rotary: 12066 Stens: 285-105	\$69.00
	618-0624 618-0659 918-0624 918-0659	Assembly	Fits LT1040, LT1042, and RZT models with 42" cut decks and star hole blades.	Oregon: 82-408 Rotary: 12973 Stens: --	\$76.00
	717-0906 917-0906	Assembly	Fits 600 and 805 series mowers with 32" and 42" G decks and 38" F decks. Uses our B1MT300 blade adapter.	Oregon: 82-500 Rotary: 7155 Stens: 285-110	\$39.00
	717-0912	Assembly	Fits 800 and 849 series mowers with 46" H decks (center and right spindle) Outer spindle for 44" decks.	Oregon: 82-502 Rotary: 8967 Stens: 285-088	\$58.00
	717-0913 917-0913	Assembly	Fits 806 series mowers with 46" decks Left hand spindle for "H" decks.	Oregon: 82-503 Rotary: 8968 Stens: 285-084	\$62.00
	712-0417 912-0417	Pulley Nut	Fits our B1MT51, B1MT53, B1MT54 B1MT55, and B1MT202 spindle assemblies.	Oregon: 04-015 Rotary: 10228 Stens: 285-104	\$2.50
	717-0900 919-0900	Assembly	Fits mowers with 32" D decks and 36" E decks.	Oregon: 82-501 Rotary: 7156 Stens: 285-092	\$42.00

Spindles







**MTD**

	OEM PART NO	TYPE	DESCRIPTION	CROSS REFERENCE	PRICE EACH
	9321	Assembly	Fits models 36" decks. Includes top and bottom bearings.	Oregon: -- Rotary: 856 Stens: 285-189	\$41.00
	08253 08253B	Bearing Housing	Bearing housing for our B1MT17, B1MT32, B1MT33 and B1SB7156.	Oregon: 45-108 Rotary: 367 Stens: --	\$6.00



**MURRAY**

	OEM PART NO	TYPE	DESCRIPTION	CROSS REFERENCE	PRICE EACH
	20511, 24384 24835, 492574 90905, 92574	Housing	Fits LT models with 28"-52" decks and GT models with 46"-52" decks. Complete with bearings, spacer, and grease fitting.	Oregon: 82-243 Rotary: 2925 Stens: 285-332	\$21.00
	774091 94129	Shaft	Shaft for our B1SB2925.	Oregon: 85-028 Rotary: 9906 Stens: 285-097	\$10.50
	--	Housing Repair Kit	Fits our B1SB2925. Contains (1) B1SB12-65 bearing, (1) B1SB483 bearing, (1) B1MU50 Spacer, (1) B1MU59 jackshaft nut (1/2"-20 UNF) and (1) B1MU68 jackshaft nut (9/16" - 18 UNF)	Oregon: -- Rotary: 8320 Stens: 285-432	\$11.00
	1001046 1001200	Assembly	Fits models with 38", 40", 42", 46", 48" 50" and 52" decks from 1997 - present.	Oregon: -- Rotary: 2925 Stens: 192-260	\$29.40
	1001195	Shaft	For our B1MU155.	Oregon: -- Rotary: -- Stens: --	\$10.40
	455962 55962 55962E701	Housing	Fits 30502 model rear-engine riders with 30" decks. Includes bearings. Use with splined pulley. Use our B1MU50 spacer.	Oregon: 82-250 Rotary: 7765 Stens: 285-435	\$34.60
	491921 91921	Shaft	Fits front-engine rider with 38" and 42" decks. 6-1/4" L x 5/8" OD. Use with B1SB5935 blade adapter.	Oregon: 85-012 Rotary: 7282 Stens: 285-187	\$11.00
	20616	Shaft	Fits 36" decks from 1978-1988 and 42" decks from 1976-1990 with short shafts. Keyway for #505 woodruff key. 5-1/4" L x 5/8" OD. 1/2" - 20 UNF.	Oregon: 85-001 Rotary: 2904 Stens: 285-239	\$9.10



**MURRAY**

	OEM PART NO	TYPE	DESCRIPTION	CROSS REFERENCE	PRICE EACH
	21024	Shaft	Fits 36" decks from 1978-1988 with long shafts. Keyway for #505 woodruff key. 6-1/2" L x 5/8" OD. 1/2"- 20 UNF.	Oregon: -- Rotary: 2931 Stens: --	\$10.30
	24578 424578	Shaft	Fits models with 25", 30" and 36" LT decks. Keyway for #505 Woodruff key. 5-3/4" L x 5/8" OD. 1/2" - 20 UNF.	Oregon: 85-005 Rotary: 2937 Stens: 285-452	\$11.00
	491922 91922	Shaft	Fits models with 36"-42" decks with splined shafts. 7-3/4" L x 5/8" OD x 1-1/4" shoulder OD. 9/16" - 18 UNF thread.	Oregon: 85-008 Rotary: 6890 Stens: 285-130	\$8.00
	492849 92849	Shaft	Fits 38", 40" and 42" decks.	Oregon: 85-029 Rotary: -- Stens: 285-095	\$10.00
	15X72	Pulley Nut	Fits our B1SB2904, B1SB2931, and B1SB2937 spindle shafts. Also part of our B1MU54 spindle housing repair kit.	Oregon: 04-536 Rotary: 9296 Stens: 416-719	\$0.80
	15X100	Pulley Nut	Fits our B1MU48 and B1MU160 spindle shafts. Also part of our B1MU54 spindle housing repair kit.	Oregon: -- Rotary: 9329 Stens: 285-183	\$1.20

**NOMA**

	OEM PART NO	TYPE	DESCRIPTION	CROSS REFERENCE	PRICE EACH
	307534, 56424 327519, 303534 313823, 39493 50632, 51450, 779066	Assembly	Fits models with 36", 38", 43" and 45" decks. Height: 6-5/8", Pulley: 5-1/2", Saddle: 2".	Oregon: 82-493 Rotary: 1172 Stens: 285-221	\$49.00
	310675 779058	Assembly	Fits front-engine rider models 4158-00, 03, 04, 06 and 11 with 45" decks. Center quill assembly. Height: 6-5/8", Double Pulley: 5-1/2", Saddle: 2".	Oregon: 82-020 Rotary: 7251 Stens: --	\$102.00



**POULAN**

	OEM PART NO	TYPE	DESCRIPTION	CROSS REFERENCE	PRICE EACH
	532 12 16-87	Assembly	Fits models with 38" and 44" decks. Height: 6-5/8", Pulley: 5-1/2", Saddle: 2-1/4".	Oregon: 82-678 Rotary: 6813 Stens: 285-031	\$60.00
	17000612 17060612 17490612 817000612	Mounting Bolt	Fits our B1AM91 spindle assembly. Self-tapping. Package quantity: 10.	Oregon: 02-301 Rotary: 9373 Stens: 285-134	\$0.99





## Spindles



### SCAG

	OEM PART NO	TYPE	DESCRIPTION	CROSS REFERENCE	PRICE EACH
	46631, 46020 46400, 461663	Assembly	Fits Turf Tiger, Sabre Tooth Tiger, Wildcat, and others with a cast iron spindle.	Oregon: 82-325 Rotary: 9153 Stens: 285-597	\$108.00
	46020 46400	Assembly	Aluminum version of B1SC72.	Oregon: 82-309 Rotary: 5722 Stens: 285-201	\$96.00
	43001-02	Shaft	Shaft for our B1CO73.	Oregon: 82-305 Rotary: 5999 Stens: --	\$24.00



### SNAPPER

	OEM PART NO	TYPE	DESCRIPTION	CROSS REFERENCE	PRICE EACH
	7-6379 5-9759	Assembly	Fits models with 32" and 36" decks. Short shaft.	Oregon: 82-306 Rotary: 1226 Stens: 285-809	\$120.00
	7-6645 5-9964	Assembly	Fits models with 48" decks. Long shaft.	Oregon: 82-307-0 Rotary: 1227 Stens: 285-940	\$122.00



### TORO

	OEM PART NO	TYPE	DESCRIPTION	CROSS REFERENCE	PRICE EACH
	112-0460	Assembly	Fits LT1040, LT1042, and RZT models with 42" cut decks and star hole blades.	Oregon: 82-408 Rotary: 12973 Stens: --	\$76.00
	112-0330	Pulley Nut	Fits some Toro spindles.	Oregon: 82-517 Rotary: 12066 Stens: 285-105	\$2.40

### TROY BILT

	OEM PART NO	TYPE	DESCRIPTION	CROSS REFERENCE	PRICE EACH
	918-0574	Assembly	Fits newer 600 series mowers with 36" and 42" decks. 6 point star center hole	Oregon: 82-517 Rotary: 12066 Stens: 285-105	\$69.00
	712-0417 912-0417	Pulley Nut	Fits our B1MT202 spindle assembly.	Oregon: 04-015 Rotary: 10228 Stens: 285-104	\$2.50

**WRIGHT**

	OEM PART NO	TYPE	DESCRIPTION	CROSS REFERENCE	PRICE EACH
	71460007	Assembly	Fits Stander models with 48", 52" and 61" decks.	Oregon: 82-309 Rotary: 5722 Stens: 285-201	\$92.00
	71460020	Shaft	Shaft for our B1CO73.	Oregon: 82-305 Rotary: 5999 Stens: --	\$22.00
	71460007	Assembly	Cast iron version of our B1CO73. Fits Stander models.	Oregon: 82-325 Rotary: 9153 Stens: 285-597	\$98.00



Carlisle has a long history of manufacturing tires and wheels for the lawn and garden industry. We offer an unmatched breadth of line filled with proven tread patterns and durable rubber compounds to meet every specialty tire need. Carlisle's strong position as a supplier of tire and wheel assemblies to Original Equipment Manufacturerers makes Carlisle the brand of choice for replacement needs. All of this is backed by Carlisle's industry leading two year warranty. Carlisle is a U.S. based company with a strong R&D and manufacturing presence in the U.S. supporting their commitment to innovation and quality.

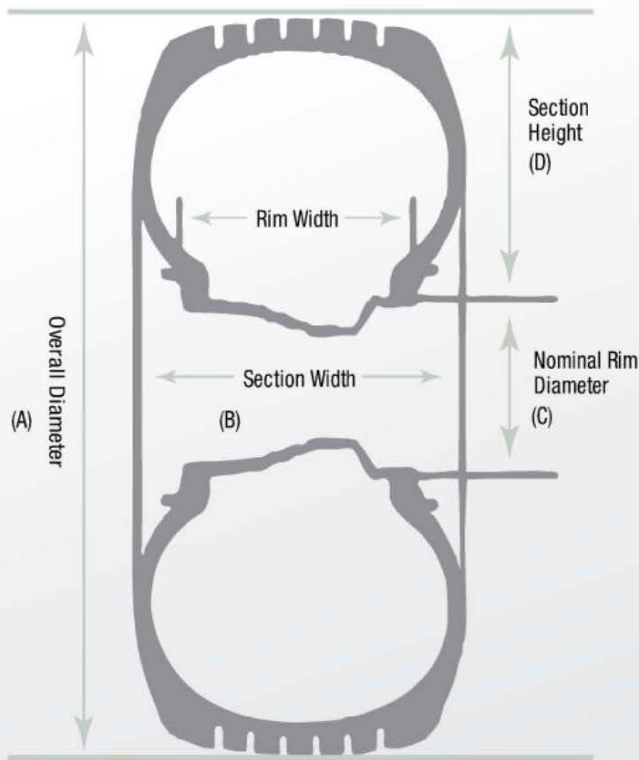

### How to Measure Your Tire

SIZE	TYPICAL SIZE
(A) (B) (C) 16 x 6.50 - 8	Lawnmowers
(B) (D) (C) 4.10/3.50 - 4	Industrial; Go Carts

The diagram illustrates the 2 most common ways to measure Lawnmower and Industrial/Go Kart tires.

All Turf Handlers are non-highway Service tires



### Turf Handlers

These tires protect the turf without sacrificing traction and provide options for a variety of applications. The commercial grade compounds and tread designs of Multi Trac and Turf Master will keep the professionals busy. Homeowners often choose the Turf Saver or Turf Saver II. Whatever the job, we've got a Turf tire to handle it.



#### MULTI-TRAC

Product No.	Dimension	Ply	MTD Diameter	MTD Width	Rim Width	Max Load Capacity/ 10 MPH	Max PSI	Tire Weight	Price
B1TI548	18 x 8.5 x 8	8	17.7	8.3	7.00	1220	44	13.20	\$104.00
B1TI500	18 x 10.5x 10	4	17.8	10.1	8.00	990	20	12.20	\$95.00
B1TI546	18 x 7 x 8	4	17.9	6.9	5.38	785	26	8.70	\$73.00
B1TI554	18 x 8.5 x 10	4	18.1	8.3	7.00	795	22	9.80	\$88.00
B1TI550	18 x 9.5 x 8	6	18.2	9	7.00	1320	36	11.90	\$105.00
B1TI551	20 x 8 x 8	2	19.4	8.8	6.50	625	12	11.00	\$84.00
B1TI558	20 x 10 x 10	6	19.6	9.6	8.00	1450	32	17.20	\$135.00
B1TI560	23 x 8.5 x12	6	22.6	8.3	7.00	1440	34	18.40	\$125.00
B1TI144	23 x 10.5 x 12	6	22.6	10.4	8.50	1760	32	21.70	\$149.00
B1TI567	24 x 8.50 x 14	4	24	8.5	7.00	1230	22	17.90	\$149.00
B1TI148	24 x 9.5 x 12	4	24	9.5	7.00	1430	22	17.20	\$125.00
B1TI568	25 x 8.50 x 14	4	25	8.5	7.00	1320	22	20.10	\$154.00
B1TI569	25 x 8.50 x 14	6	25	8.5	7.00	1640	32	23.50	\$222.00
B1TI565	26 x 12 x 12	4	25.2	12.2	8.50	1780	20	26.10	\$149.00
B1TI566	26 x 12 x 12	6	25.2	12.2	8.50	2250	30	29.20	\$176.00
B1TI570	27 x 8.5 x 15	4	26.6	8.5	7.00	1230	30	25.30	\$228.00
B1TI571	27 x 8.5 x 15	6	26.6	8.6	7.00	1570	45	25.60	\$277.00
B1TI573	27 x 10.5 x 15	4	26.9	10.2	8.50	1320	30	29.00	\$284.00
B1560362	31 x 13.5 x 15	4	31.5	13.2	10.50	2150	20	46.00	\$364.00
B1560361	36 x 14 x 15	4	36	14	10.00	2600	20	52.00	\$408.00

#### TURF CTR

Product No.	Dimension	Ply	MTD Diameter	MTD Width	Rim Width	Max Load Capacity/ 10 MPH	Max PSI	Tire Weight	Price
B1SB6832	22 X 11 X 8	4	22.4	10.8	9.00	9	10	12.80	\$84.00





**TURF MASTER**

Product No.	Dimension	Ply	MTD Diameter	MTD Width	Rim Width	Max Load Capacity/ 10 MPH	Max PSI	Tire Weight	Price
B1TI249	13 x 6.50 x 6	4	13.1	6.3	4.50	460	28	5.40	\$50.00
B1TI252	15 x 6.00 x 6	4	14.4	6.2	4.50	570	30	4.70	\$51.00
B15112531	15 x 6.50 x 8	2	15.0	6.3	5.38	415	14	6.20	\$53.00
B1TI401	16 x 6.50 x 8	4	16.3	6.4	5.38	620	28	7.00	\$54.00
B1TI402	16 x 7.50 x 8	4	16.4	7.1	5.38	680	24	8.40	\$66.00
B1TI415	18 x 6.50 x 8	4	17.5	6.4	5.38	770	28	7.20	\$86.00
B1TI404	18 x 8.50 x 8	4	18.0	8.2	7.00	815	22	10.60	\$86.00
B1TI417	18 x 9.50 x 8	4	18.1	9.2	7.00	1040	24	10.70	\$86.00
B1TI405	20 x 10.00 x 8	4	19.6	10.4	7.00	1190	22	14.10	\$100.00
B1TI412	20 x 10.00 x 10	4	20.0	8.8	6.00	1160	22	13.60	\$105.00
B15114281	20 x 8.00 x 10	4	20.3	8.2	6.00	910	24	14.10	\$84.00
B1511255	22 x 11.00 x 10	4	21.4	10.4	7.00	1485	20	16.10	\$128.00
B1TI408	23 x 10.5 x 12	4	22.8	10	8.50	1340	20	16.80	\$110.00
B1TI418	23 x 8.50 x 12	4	22.9	8.4	7.00	1120	22	15.90	\$105.00
B1TI409	24 x 12.00 x 12	4	23.3	11.4	8.50	1700	20	19.70	\$123.00
B1TI406	23 x 9.50 x 12	4	23.6	9.8	7.00	1380	24	19.30	\$114.00

**TURF SAVER**

Product No.	Dimension	Ply	MTD Diameter	MTD Width	Rim Width	Max Load Capacity/ 10 MPH	Max PSI	Tire Weight	Price
B1TI265	9 x 3.5 x 4	4	8.9	3.5	2.50	165	30	2.20	\$22.00
B1TI3	4.10/3.50 x 4	2	10.8	3.8	2.50	230	24	2.70	\$20.00
B1TI10	11 x 4 x 5	2	10.8	4	3.00	210	22	2.80	\$23.00
B1TI9	11 x 4 x 4	2	11.2	4.2	2.50	215	22	3.00	\$22.00
B1TI31	13 x 5 x 6	2	12.9	4.7	3.50	295	20	4.20	\$25.00
B1TI41	13 x 5 x 6	4	12.9	4.8	3.50	440	40	3.40	\$30.00
B1TI30	13 x 6.5 x 6	2	13.2	6.5	4.50	305	14	4.20	\$32.00
B1TI32	13 X 6.5 X 6	4	13.4	6.3	4.50	460	28	5.90	\$39.00
B1TI35	15 X 6 X 6	2	14.5	6.2	4.50	365	14	5.60	\$32.00
B1TI65	16 X 6.5 X 8	2	16.1	6.5	5.38	380	12	6.30	\$37.00
B1TI45	4.80/4.00 X 8	2	16.3	5	3.75	435	20	4.90	\$32.00
B1TI66	16 X 6.5 X 8	4	16.3	6.4	5.38	620	28	5.70	\$44.00
B1SB6541	16 X 7.5 X 8	2	16.5	7.1	5.38	475	12	7.60	\$43.00

All Turf Handlers are non-highway Service tires

## TURF SAVER

Product No.	Dimension	Ply	MTD Diameter	MTD Width	Rim Width	Max Load Capacity/ 10 MPH	Max PSI	Tire Weight	Price
B1TI63	18 x 6.5 x 8	2	17.2	6.5	5.38	515	14	7.60	\$53.00
B1TI62	18 x 6.5 x 8	4	17.6	6.7	5.38	770	28	6.60	\$57.00
B1TI73	18 x 8.5 x 8	2	17.8	8.3	7.00	515	10	9.00	\$66.00
B1TI74	18 x 8.5 x 8	4	18.0	8.2	7.00	815	22	10.30	\$74.00
B1TI85	18 x 9.5 x 8	4	18.1	9.6	7.00	1040	24	10.70	\$76.00
B1TI78	18 x 9.5 x 8	6	18.5	9.5	7.00	1320	36	11.70	\$87.00
B1TI122	20 x 8 x 8	2	19.1	9.1	7.00	600	10	9.60	\$78.00
B1SB7202	20 x 10 x 8	2	19.6	10.1	7.00	750	10	13.00	\$88.00
B1TI115	20 x 8 x 10	4	20.0	7.9	6.00	895	24	11.70	\$76.00
B1TI120	20 x 10 x 10	4	20.8	8.8	6.00	1225	24	12.70	\$98.00
B1TI134	22 x 9.5 x 12	2	21.3	8.9	7.00	1410	14	13.00	\$95.00
B1TI136	23x 10.5 x 12	2	22.6	10.5	8.50	890	10	15.20	\$103.00
B1TI135	23 x 10.5 x 12	4	22.8	10.3	8.50	1340	20	16.50	\$118.00
B1TI137	24 x 12 x 12	2	23.0	11.6	8.50	1135	10	18.70	\$138.00
B1TI126	23 x 8.5 x 12	2	23.1	8.5	7.00	705	10	12.90	\$93.00
B1TI131	23 x 9.5 x 12	2	23.2	9.5	7.00	920	12	14.20	\$97.00

## TURF SAVER II

Product No.	Dimension	Ply	MTD Diameter	MTD Width	Rim Width	Max Load Capacity/ 10 MPH	Max PSI	Tire Weight	Price
B1TI201	13 X 5.00 X 6	2	12.3	4.6	3.50	295	20	3.80	\$25.00
B1TI202	15 X 6.00 X 6	2	14.3	6	4.50	365	14	5.30	\$32.00
B1TI203	16 X 6.50 X 8	2	16.0	6.2	5.38	415	14	5.90	\$39.00
B1TI204	18 X 8.50 X 8	2	17.8	8.4	7.00	515	10	6.30	\$64.00
B1TI205	18 X 9.50 X 8	2	17.8	9.1	7.00	695	12	6.50	\$64.00
B1TI206	20 X 8.00 X 8	2	19.0	8.9	7.00	600	10	7.70	\$71.00



## TURF TRAC R/S

Product No.	Dimension	Ply	MTD Diameter	MTD Width	Rim Width	Max Load Capacity/ 10 MPH	Max PSI	Tire Weight	Price
B1TI707	11 x 4.00 x 5	2	10.6	4	3.00	210	22	2.40	\$33.00
B1TI712	15 x 6.00 x 6	4	14.4	6.3	4.50	570	30	4.60	\$54.00
B1TI714	16 x 6.50 x 8	4	16.0	6.8	5.38	620	28	6.90	\$57.00
B1TI764	18 x 8.50 x 8	4	17.7	8.1	7.00	815	22	7.30	\$74.00

All Turf Handlers are non-highway Service tires



**TURF TRAC R/S**

Product No.	Dimension	Ply	MTD Diameter	MTD Width	Rim Width	Max Load Capacity/ 10 MPH	Max PSI	Tire Weight	Price
B1TI769	20 x 10.00 x 8	4	19.5	9.9	8.00	1190	22	10.50	\$91.00
B1TI774	20 x 10.00 x 10	4	19.6	9.3	8.00	1160	22	10.10	\$101.00
B1TI776	22 x 9.5 x 10	4	21.7	9.5	7.00	980	14	14.30	\$107.00
B15753B7	22.5 x 10.00 x 8	4	22.6	9.6	8.00	1390	22	15.00	\$118.00
B1TI782	23 x 10.50 x 12	4	22.4	10.1	8.50	1340	20	13.00	\$115.00
B1TI783	24 x 12.00 x 12	4	23.5	11	8.50	2240	32	21.30	\$151.00
B1TI777	24 x 9.5 x10	4	24.3	9.8	7.00	1410	22	16.10	\$111.00
B15753A6	24 x 12.00 x 10	4	24.6	11.7	8.00	1780	22	13.00	\$134.00
B1TI784	26 x 12.00 x 12	10	25.3	12.4	8.50	3100	52	24.40	\$196.00
B150D3T7	25 x 12.00 x 9	4	25.7	11.6	9.50	1820	20	17.90	\$123.00

**ULTRA TRAC**

Product No.	Dimension	Ply	MTD Diameter	MTD Width	Rim Width	Max Load Capacity/ 10 MPH	Max PSI	Tire Weight	Price
B1TI726	24 X 13.00 X 12	6	22.7	13	10.50	2240	28	28.30	\$216.00
B1TI725	24 X 13.00 X 12	4	23.2	13	10.50	1730	18	26.30	\$188.00
B1TI727	26.5 X 14.00 X 12	4	26.5	14.4	11.00	2170	18	30.60	\$235.00
B1TI728	29.14.00 X 15	6	29.0	14	11.00	1710	30	44.50	\$389.00



**Golf Gliders**

This line of tubeless golf and utility tires carry their loads without wear and tear on the fairway and ride smoothly on paved paths. They work well as a wide-flotation tire for on-site transport on heavy duty jobs.



**FAIRWAY PRO**

Product No.	Dimension	Ply	MTD Diameter	MTD Width	Rim Width	Max Load Capacity/ 10 MPH	Max PSI	Tire Weight	Price
B1TI82	18 X 8.5 X 8	4	18.2	8.4	7.00	815	22	11.80	\$60.00

**LINKS**

Product No.	Dimension	Ply	MTD Diameter	MTD Width	Rim Width	Max Load Capacity/ 10 MPH	Max PSI	Tire Weight	Price
B1TI70	18 X 8.5 X 8	4	17.4	8.5	7.00	815	22	13.20	\$74.00

**Under and over inflated tires wear more quickly**

Always keep your tires inflated to the pressure recommended in your operator's manual.





## Smooth Operators

These tires make optimum contact with a variety of surfaces for easy-flowing traction and a smooth roll.

Use for: Wheelbarrows, transport vehicles, riding mowers, garden tractors and farm equipment.



### SMOOTH

Product No.	Dimension	Ply	MTD Diameter	MTD Width	Rim Width	Max Load Capacity/ 10 MPH	Max PSI	Tire Weight	Price
B1SB8194	8.00 x 3.00 x 4	4	8.2	2.9	2.50	120	30	1.70	\$22.00
B1TI5	9 x 3.50 x 4	4	8.7	3.7	2.50	260	50	2.30	\$23.00
B1TI51	11 x 4.00 x 5	4	11.0	4	3.00	325	46	3.20	\$27.00
B1TI39	13 x 5.00 x 6	4	12.7	4.8	4.50	440	40	4.10	\$39.00
B1TI29	13 x 6.50 x 6	4	12.9	5.9	3.75	460	28	4.00	\$39.00
B1TI55	4.80 x 8	4	16.8	4.8	7.00	760	70	4.10	\$37.00
B1TI100	18 x 9.50 x 8	4	17.8	8.7	7.00	1040	24	8.30	\$76.00
B1TI57	18 x 10.50 x 10	2	18.1	10	8.50	730	12	11.20	\$111.00
B1TI58	20 X 10.00 X 10	2	19.6	9.5	8.00	815	12	11.90	\$101.00

### STRAIGHT RIB

Product No.	Dimension	Ply	MTD Diameter	MTD Width	Rim Width	Max Load Capacity/ 10 MPH	Max PSI	Tire Weight	Price
B15180111	11 X 4.00 X 5	4	11.1	4.2	3.00	325	46	3.20	\$27.00
B1TI94	13 X 5.00 X 6	4	12.9	4.7	3.50	440	40	2.50	\$30.00
B1TI28	13 X 6.50 X 6	4	13.0	5.9	4.50	460	28	4.00	\$36.00
B1TI830	15 X 6.00 X 6	4	14.5	6.1	4.60	570	30	3.90	\$39.00
B1TI68	16 X 6.50 X 8	4	16.2	6.4	5.38	620	28	5.20	\$56.00
B1TI95	18 X 9.50 X 8	4	17.7	9.3	7.00	1040	24	9.40	\$69.00
B1TI121	20 X 10.00 X 10	4	20.0	8.7	6.00	1160	22	12.80	\$100.00
B1TI97	26 X 12.00 X 12	4	25.0	11.7	10.50	1780	20	22.30	\$142.00

### WHEELBARROW

Product No.	Dimension	Ply	MTD Diameter	MTD Width	Rim Width	Max Load Capacity/ 10 MPH	Max PSI	Tire Weight	Price
B1SB903	4.00 X 6	2	13.6	3.9	2.50	330	30	2.00	\$17.00
B1TI79	4.80 X 8	2	15.8	3.9	2.50	550	30	2.50	\$19.00
B1TI60	4.80 X 8	4	16.3	4.5	3.75	765	70	3.40	\$23.00



### Gripping Performers

These specially designed tread patterns with two-way traction perform well on drive and free wheels.

Use for: utility carts, wheelbarrows, pressure washers, generators, hand trucks, lawn equipment and fun carts.



#### SAWTOOTH

Product No.	Dimension	Ply	MTD Diameter	MTD Width	Rim Width	Max Load Capacity/ 10 MPH	Max PSI	Tire Weight	Price
B1SB879	2.8 X 4	4	9.0	2.9	2.50	180	50	1.70	\$22.00
B1TI341	4.10/3.50 X 4	4	10.5	3.8	2.50	350	50	2.20	\$26.00
B1SB906	4.1 X 4	2	10.6	3.6	2.50	230	24	2.50	\$20.00
B1TI342	4.10/3.50 X 6	4	12.9	4.3	3.25	495	85	3.30	\$32.00
B1TI343	5.30/4.50 X 6	6	14.6	5.3	3.50	885	95	5.10	\$57.00
B1SB837	4.80/4.00 X 8	2	16.0	4.6	3.75	510	35	5.10	\$30.00

#### STUD

Product No.	Dimension	Ply	MTD Diameter	MTD Width	Rim Width	Max Load Capacity/ 10 MPH	Max PSI	Tire Weight	Price
B1TI15	4.10/3.50 X 4	2	10.6	3.6	2.50	230	24	2.60	\$20.00
B1TI20	4.10/3.50 X 5	2	11.6	3.8	3.00	260	24	2.40	\$22.00
B1TI25	4.10/3.50 X 6	2	12.5	3.9	3.25	290	24	3.20	\$23.00
B1TI27	4.80/4.00 X 8	4	16.3	4.7	3.75	670	42	5.80	\$33.00
B1TI40	4.80/4.00 X 8	2	16.4	4.7	3.75	435	20	4.80	\$29.00



### Prolonging the life of your tires

Did you know that ultraviolet rays from the sun can damage your tires and lead to premature failure? Store your mower indoors or cover your mower when not in use to prolong tire life.



All Turf Handlers are non-highway Service tires





### Big Biters

These All-Americans with their bar tread design put power to the ground for equipment that demands pure traction in hard and loose soil as well as snow.

Use for: Riding Mowers, Garden Tractors, Snowthrowers, Tillers, ATVs and Utility Vehicles.



#### AT 101 CHEVRON

Product No.	Dimension	Ply	MTD Diameter	MTD Width	Rim Width	Max Load Capacity/ 10 MPH	Max PSI	Tire Weight	Price
B1TI271	21 X 11 X 10	4	20.9	10.4	8.50	1380	22	15.80	\$130.00
B1TI270	21 X 11 X 8	4	21.2	10.9	8.50	1430	22	14.80	\$121.00
B1TI272	24 X 12 X 12	4	23.8	12.2	8.50	1700	20	21.00	\$142.00

#### POWER TRAC/POWER TRAC II

Product No.	Dimension	Ply	MTD Diameter	MTD Width	Rim Width	Max Load Capacity/ 10 MPH	Max PSI	Tire Weight	Price
B1TI147	4.80 X 8	2	16.1	4	2.50	435	20	6.20	\$57.00



### Skid Steer

These tires feature unique lug designs, heavy gauge side-walls, and premium materials. This ensures optimum service life. Key sizes incorporate built-in rim guard for increased protection against debris and lateral hazards. Use for skid steers, backhoes, and subcompact tractors.



## Tire maintenance

A tire can lose up to half its pressure and not appear to be flat. Always check the pressure in your tires before each use and keep your tires inflated at the maximum PSI recommended in your operator's manual. It is critical to follow the operator's manual specifications and not the pressure specification on the tires as the recommended tire pressure in the operator's manual may be different. Using the recommended tire pressure will help to ensure a more comfortable ride and help to prevent premature tire wear or turf damage.





**SUPER LUG**

Product No.	Dimension	Ply	MTD Diameter	MTD Width	Rim Width	Max Load Capacity/ 10 MPH	Max PSI	Tire Weight	Price
B1TI33	13 X 5.00 X 6	2	13.1	4.5	3.50	295	20	4.20	\$29.00
B1TI426	14 X 4.50 X 6	2	14.5	4.6	3.25	320	20	5.00	\$30.00
B1TI71	16 X 6.50 X 8	4	16.2	6.3	5.38	620	28	7.50	\$67.00
B1TI90	18 X 9.50 X 8	2	18.1	8.8	7.00	1040	24	11.90	\$86.00
B1TI112	20 X 10.00 X 8	4	20.1	9.7	7.00	1190	22	17.30	\$95.00

**TRU POWER**

Product No.	Dimension	Ply	MTD Diameter	MTD Width	Rim Width	Max Load Capacity/ 10 MPH	Max PSI	Tire Weight	Price
B1TI83	18 X 8.5 X 10	4	18.1	7.6	6.00	830	22	10.00	\$95.00
B15233C3	6-12	4	22.7	5.7	5.00	590	28	12.10	\$98.00
B1TI175	26 X 12 X 12	4	25.6	12.3	8.50	1780	20	30.10	\$171.00

**TRAC CHIEF**

Product No.	Dimension	Ply	MTD Diameter	MTD Width	Rim Width	Max Load Capacity/ 10 MPH	Max PSI	Tire Weight	Price
B151S311	18 X 8.50 X 10	4	18.2	8	7.00	830	22	13.90	\$135.00
B151S3G8	23 X 8.50 X 12	6	22.6	8.4	7.00	1820	50	32.60	\$222.00
B151S379	25 X 8.50 X 14	6	25.8	8.4	7.00	2130	50	26.70	\$250.00
B1TI754	26 X 12.00 X 12	4	25.5	12.4	10.50	1780	20	33.50	\$281.00
B1TI751	10 X 16.5	8	30.8	10.4	8.25	4140	60	44.00	\$263.00
B1560386	12 X 16.5	6	33.1	12.2	9.75	4220	40	86.44	\$236.00
B1510027	14 X 17.5	6	35.7	13.7	10.50	3805	30	86.40	\$568.00

**USA LOADER**

Product No.	Dimension	Ply	MTD Diameter	MTD Width	Rim Width	Max Load Capacity/ 10 MPH	Max PSI	Tire Weight	Price
B1TI856	10.00 X 16.5	10	30.9	10.6	8.25	4720	75	58.00	\$357.00
B1TI859	12.00 X 16.5	10	32.9	12.6	9.75	5600	65	73.40	\$497.00

All Turf Handlers are non-highway Service tires



**ATV/UTV**

These rugged tires are designed with durable rubber compounds and strong nylon cord construction, offering the ultimate in cut and impact resistance.



**ALL-TRAIL/ALL TRAIL II**

Product No.	Dimension	Ply	MTD Diameter	MTD Width	Rim Width	Max Load Capacity/ 10 MPH	Max PSI	Tire Weight	Price
B155A3N1	22 X 9.50 X 10	4	22.0	9.5	7.75	1280	22	15.20	\$121.00
B1T1805	23 X 10.5 X 12	4	23.1	9.9	7.00	1340	20	24.40	\$131.00
B1T1803	24 X 9.5 X 10	4	24.0	9.7	7.50	1410	22	15.00	\$126.00
B1T1804	24 X 10.5 X 10	4	24.5	10.8	8.00	1490	20	18.00	\$135.00
B1560443	25 X 9 X X12	4	25.6	9	7.00	815	20	18.40	\$151.00

**AT489**

Product No.	Dimension	Ply	MTD Diameter	MTD Width	Rim Width	Max Load Capacity/ 10 MPH	Max PSI	Tire Weight	Price
B1T1902	AT22 X 11 X 10	2	22.2	10.6	9.00	330	7	15.60	\$132.00
B1T1903	AT23 X 7 X 10	2	22.7	6.5	5.50	240	5	12.40	\$115.00
B15793P2	AT24 X 9.50 X 10	4	24.0	9.5	7.50	1410	22	18.00	\$139.00
B1T1907	AT24 X 11 X 12	3	24.4	10.1	9.00	340	7	20.10	\$154.00
B1T199	AT24 X 9 X 11	3	247.5	8.6	7.00	365	7	18.00	\$125.00
B15793A6	AT24 X 12 X 10	4	24.5	11.7	9.50	1740	20	21.80	\$158.00
B1T1916	AT25 X 11 X 10	3	25.1	10.6	9.00	455	7	20.30	\$149.00
B1T1911	AT25 X 8 X 12	3	25.2	7.5	6.50	340	7	15.20	\$118.00
B1589321	AT25 X 10 X 12	3	25.2	9.1	8.00	420	7	19.20	\$141.00
B1560434	AT25 X 11 X 12	3	25.4	10.6	8.00	455	7	21.10	\$145.00

**HD FIELD TRAX**

Product No.	Dimension	Ply	MTD Diameter	MTD Width	Rim Width	Max Load Capacity/ 10 MPH	Max PSI	Tire Weight	Price
B15883U1	18 X 8.50 X 10	4	18.2	7.4	7.00	830	22	11.00	\$100.00
B1T1704	AT22 X 12 X 8	3	21.3	11.7	9.50	430	7	20.80	\$113.00
B1T1700	AT22.5 X 10.00 X 8	3	22.5	10.2	7.00	365	7	20.50	\$111.00
B1560366	24 X 12 X 12	2	24.0	11.6	9.50	1135	10	24.70	\$148.00
B1T1703	AT25 X 13 X 9	3	24.8	12.4	10.50	535	7	27.10	\$138.00
B1T1718	26 X 12.00 X 12	2	25.6	11.8	9.50	1185	10	25.90	\$162.00





**KNOBBY**

Product No.	Dimension	Ply	MTD Diameter	MTD Width	Rim Width	Max Load Capacity/ 10 MPH	Max PSI	Tire Weight	Price
B1SB6594	AT145/70 X 6	2	14.3	5.3	5.38	80	4	4.90	\$33.00
B1TI86	AT18 X 9.50 X 8	2	18.3	8.8	7.00	625	10	10.60	\$74.00
B1TI906	AT22 X 11 X 8	2	21.6	10.7	9.00	495	10	14.40	\$91.00

**STRYKER**

Product No.	Dimension	Ply	MTD Diameter	MTD Width	Rim Width	Max Load Capacity/ 10 MPH	Max PSI	Tire Weight	Price
B1531065	AT22 X 11.00 X 9	belted	22.6	11.2	10.00	340	5	22.30	\$121.00
B1TI914	AT22 X 11 X 10	2	22.9	10.1	8.25	330	5	20.80	\$114.00

**TRAIL WOLF**

Product No.	Dimension	Ply	MTD Diameter	MTD Width	Rim Width	Max Load Capacity/ 10 MPH	Max PSI	Tire Weight	Price
B1TI900	AT25 X 8 X 12	2	25.3	7.5	6.50	340	7	16.40	\$118.00
B1TI921	25 X 11 X 12	2	25.7	9.1	8.00	455	7	20.60	\$134.00
B1TI901	AT26 X 10 X 12	2	26.8	9.4	8.00	440	7	23.00	\$117.00

**TURF TAMER**

Product No.	Dimension	Ply	MTD Diameter	MTD Width	Rim Width	Max Load Capacity/ 10 MPH	Max PSI	Tire Weight	Price
B155U3C7	AT22.5 X 10.00 X 8	4	22.8	9.2	8.00	1390	22	14.20	\$113.00
B1TI701	AT25 X 12 X 9	3	25.3	11.2	9.50	495	7	17.50	\$125.00



**Trailer**

Approved for over-the-highway use, these tires comply with U.S. Department of Transportation requirements. Their long-lasting, wrap-around tread provides sure cornering and safe travel.



## SPORT TRAIL

Product No.	Dimension	Ply	MTD Diameter	MTD Width	Rim Width	Max Load Capacity/ 10 MPH	Max PSI	Tire Weight	Price
B1TI842	4.80 X 8	4	16.2	4.7	3.75	585	60	5.80	\$32.00
B1SB838	5.70 X 8	4	18.1	5.9	3.75	715	50	9.20	\$50.00
B1SB840	4.80 X 12	4	20.6	5.1	4.00	780	60	9.98	\$50.00
B1SB841	5.30 X 12	4	21.4	5.4	4.00	840	55	10.46	\$60.00
B15193321	ST185 X 80D13	4	24.7	7.3	4.50	1480	50	19.68	\$95.00

## USA TRAIL

Product No.	Dimension	Ply	MTD Diameter	MTD Width	Rim Width	Max Load Capacity/ 10 MPH	Max PSI	Tire Weight	Price
B1TI116	20.5 X 8.0 X10	4	21.0	8.4	6.00	905	35	15.80	\$88.00

### Carlisle tire service guideline

Proper tire care and safety is important. Carlisle recommends getting in the habit of taking five minutes every month to check your tires, including the spare. The most common problems for trailer tires are:

**Over-Inflation:** Tires are more likely to be cut, punctured, or broken by sudden impact when they are over-inflated. Over-inflation wears the center out faster than the outside edges.

**Under-inflation:** Tires that are under-inflated tend to get overheated. This can cause sudden tire failure that could lead to serious personal injury. Under-inflation can also reduce fuel economy through increased rolling resistance (soft tires make your vehicle work harder). When a tire is under-inflated, the shoulder of the tire bears most of the load and may show increased tread wear on the outside edges.

**Cupping or Dipping:** Cups or dips in the tread may be signs that wheels are out of balance or alignment, suspension parts are worn out, or axle damage is present.

**Uneven Wear:** If the edges of your tread take on a saw-tooth or feathered appearance, your wheels may be out of alignment. The condition is caused by erratic scrubbing against the road surface. The solution may be a toe-in or toe-out alignment correction.



Product No.	Dimension	Ply	MTD Diameter	MTD Width	Rim Width	Max Load Capacity/ 10 MPH	Max PSI	Carlisle Equivalent	Price
B1KT10	Turf Rider-K358	2	10.7	3.7	3.0	210	22	5110101	\$18.00
B1KT30	Turf Rider-K358	2	12.7	6.1	4.5	305	14	5111851	\$26.00

All Turf Handlers are non-highway Service tires

Product No.	Dimension	Ply	MTD Diameter	MTD Width	Rim Width	Max Load Capacity/ 10 MPH	Max PSI	Carlisle Equivalent	Price
B1KT32	Turf Rider-K358	4	12.7	6.1	4.5	460	28	5111861	\$30.00
B1KT35	Turf Rider-K358	2	14.4	5.9	4.5	365	14	5110301	\$25.00
B1KT65	Turf Rider-K358	2	15.8	6.3	3.75	415	14	5110951	\$32.00
B1KT66	Turf Rider-K358	4	15.9	6.5	3.8	620	28	5110961	\$36.00
B1KT122	Turf Rider-K358	2	18.8	8.9	7.0	600	10	511080	\$61.00
B1KT7202	Turf Rider-K358	2	20.0	9.7	7.0	750	12	511101	\$65.00
B1KT507	Turf 505-K505	4	14.5	6.2	4.5	570	30	574319	\$38.20
B1KT510	Turf 505-K505	4	16.0	6.5	3.75	620	28	574304	\$45.00
B1KT114	Turf 505-K505	4	19.4	9.6	7.0	1190	22	574341	\$68.00
B1KT252	Super Turf-K500	4	14.7	6.2	4.5	570	30	5112521	\$34.00
B1KT401	Super Turf-K500	4	15.7	7	3.75	620	28	5114011	\$42.00
B1KT404	Super Turf-K500	4	17.8	8.5	7.0	815	22	5114041	\$60.00
B1KT409	Super Turf-K500	4	23.4	11.8	9.5	1700	20	511409	\$99.00
B1KT5	Smooth-K404	4	9.0	3.7	2.75	160	26	5120101	\$18.00
B1KT51	Smooth-K404	4	11.2	3.9	3.0	325	46	5120111	\$19.00
B1SB351	Smooth-K404	4	12.4	3.7	3.5	440	50	--	\$25.00
B1KT39	Smooth-K404	4	12.6	4.8	3.5	440	40	5120211	\$31.00
B1KT29	Smooth-K404	4	13.1	6.1	5.0	460	28	5121861	\$32.00
B1KT15	Knobby-K352	2	10.4	3.4	2.25	260	30	5160251	\$15.00

**Tubes**

We carry a complete line of tubes for lawn and garden equipment, golf carts, ATV and UTV, hand trucks, and other industrial applications. We carry Carlisle tubes, except where noted. All tubes come individually packaged.

Product No.	Valve Stem	Dimensions	Rim Width	Carlisle Equivalent	Price
B1320020	90 Degree (JS87P)	4.10/3.50-4	4	320020	\$6.30
B1320100	L Shaped Stem (TR87)	4.10/3.50 - 4, 11 x 4-4	4	320100	\$6.30
B1320040	Straight (TR13)	4.10/3.50 - 4	4	320040	\$5.60
B1320030	L Shaped Stem (TR87)	9 x 3.50 - 4	4	320030	\$5.60
B1320031	90 Degree (JS87P)	9 x 3.50 - 4	4	320031	\$6.30
B1320150	L Shaped Stem (TR87)	3.40/3.00 5	5	320150	\$5.60
B1320060	90 Degree (JS87P)	4.10/3.50 - 5	5	320060	\$7.00
B1320200	L Shaped Stem (TR87)	4.0/3.50 - 5, 11 x 4-5	5	320200	\$7.00

All Turf Handlers are non-highway Service tires



**Tubes**

Product No.	Valve Stem	Dimensions	Rim Width	Carlisle Equivalent	Price
<b>B1320070</b>	Straight (TR13)	4.10/3.50 - 5	5	320070	\$7.00
<b>B132080</b>	L Shaped Stem (TR87)	11/4.00 - 5	5	320080	\$9.20
<b>B1320250</b>	L Shaped Stem (TR87)	10/3.50 - 6	6	320250	\$6.30
<b>B1320160</b>	Straight (TR13)	4.10/3.50 - 6	6	320160	\$6.30
<b>B1320270</b>	L Shaped Stem (TR87)	5.30/4.50-6, 13 x 6.50-6, 14.5/7.00-6	6	320270	\$9.20
<b>B1320260</b>	L Shaped Stem (TR87)	12x5.00-6, 13x5.00-6, 14x4.50 - 6	6	320260	\$7.70
<b>B1323790</b>	Straight (TR13)	13 x 5.00 - 6	6	323790	\$7.70
<b>B1320170</b>	Straight (TR13)	13 x 6.50 - 6	6	320170	\$9.90
<b>B1TU5</b>	Straight (TR13)	14.5 x 7.00 - 6	6	--	\$8.40
<b>B1323800</b>	Straight (TR13)	15 x 6.00 - 6	6	323800	\$9.20
<b>B1320290</b>	L Shaped Stem (TR87)	15 x 6.00 - 6	6	320290	\$11.30
<b>B1320110</b>	Straight (TR13)	3.00 - 8	8	320110	\$6.30
<b>B1320400</b>	Straight (TR13)	4.80/4.00-8	8	320400	\$7.00
<b>B1320450</b>	Straight (TR13)	5.70/5.00 - 8	8	320450	\$8.40
<b>B1320420</b>	Straight (TR13)	16 x 6.50/7.50 - 8	8	320420	\$8.40
<b>B132041</b>	Straight (TR13)	18x6.50/7.50/8.50/9.50 - 8, 20x8/9/10-8	8	320410	\$14.10
<b>B1320440</b>	Stright (TR6)	AT21/22 X 11.00/12.00 R8	8	320440	\$19.00
<b>B1SB7821</b>	Straight	22 X 12.00 X 9	9	--	\$31.00
<b>B1321520</b>	Straight (TR6)	AT25 X 12/13 R9	9	321520	\$22.00
<b>B1320770</b>	Straight (TR13)	20 X 8.00/10.00 - 10	10	320770	\$16.00
<b>B1320771</b>	Straight (TR6)	AT20 X 8/10 R10	10	320771	\$17.00
<b>B1SB7822</b>	Straight	22 X 12.00 X 10	10	--	\$31.00
<b>B1SB7824</b>	Straight	25 X 12.50 X 10	10	--	\$33.00
<b>B1320901</b>	Straight (TR13)	5.30/4.50 - 12, 4.80/4.00 - 12	12	320901	\$13.00
<b>B1321371</b>	Straight (TR6)	AT22/23 X 8R11/12	12	321371.	\$19.00
<b>B1321370</b>	Straight (TR13)	22 X 7.50/9.00 - 12, 23 X 8.50/9.50 - 12, 23/24 X 10.50 - 12	12	321370	\$19.00
<b>B1321050</b>	Straight (TR13)	24 X 12-12, 26 X 10.50 -12, 26 X 12 X 12	12	321050	\$21.00
<b>B1SB305</b>	Straight, Thorn Proof	16 X 2.125	16	--	\$7.00
<b>B1SB6953</b>	Straight, Economy	16 X 2.125	16	--	\$4.20
<b>B1322480</b>	Straight(TR15CW)	9.50/10 - 16.5LT	17	322480	\$27.00
<b>B1322490</b>	Straight(TR15CW)	12 - 16.5	17	322490	\$30.00
<b>B1SB304</b>	Straight, Thorn Proof	20 X 2.125	20	--	\$8.50
<b>B1SB6954</b>	Straight, Economy	20 X 2.125	20	--	\$4.20



## Tire Chains

For lawn and garden and snow thrower applications, our twist link ladder style chains provide added traction and are available in 2 or 4 link spacing. Our ATV chains feature a D shaped square link chain in a diamond pattern to keep the chain on top of the tread for superior traction. These chains are easy to install. Sold in pairs.



2 Link Chain



4 Link Chain



ATV Chain

### 2 Link Chain

Product No.	Dimensions	Rim Width	Application	Price
B1TC7106I	4.10 x 3.50 x 4/3.40 x 3.00 x 5	4"/5"		\$9.60
B1TC3302SH	4.10 x 3.50 x 6	6"	Snow Thrower Application	\$28.00
B1TC3309I	5.30 x 4.50 x 6	6"		\$24.00
B1TC7129I	13 x 5.00 x 6	6"		\$18.00
B1TC7129SH	13 x 5.00 x 6	6"	Snow Thrower Application	\$32.00
B1TC3300I	15 x 6.00 x 6	6"		\$31.00
B1TC1301I	4.00 x 4.80 x 8	8"		\$30.00
B1TC1301SH	4.00 x 4.80 x 8	8"	Snow Thrower Application	\$41.00
B1TC3303I	5.00 x 5.70 x 8	8"		\$35.00
B1TC3300SH	16 x 6.50 x 8	8"	Snow Thrower Application	\$47.00
B1TC3312I	18 x 6.50 x 8	8"		\$36.00
B1TC3307I	18 x 8.50 x 8	8"		\$39.00
B1TC3305I	18 x 9.50 x 8	8"		\$39.00
B1TC7145I	20 x 10 x 8	8"		\$61.00
B1TC1308I	20 x 8 x 8/10	10"		\$50.00
B1TC4300I	23 x 8.50 x 12	12"		\$60.00
B1TC5307I	23 x 9.50/10.50 x 12	12"		\$67.00
B1TC5300I	24 x 12 x 12	12"		\$67.00
B1TC5308I	26/27 x 12 x 12	12"		\$84.00

### 4 Link Chain

Product No.	Dimensions	Rim Width	Application	Price
B1TC3311I	18 x 8.50 x 8	8"		\$26.00
B1TC3306I	18 x 9.50 x 8	8"		\$26.00
B1TC5318I	20 x 8 x 8/10	8"/10"		\$46.00
B1TC5320I	20 x 10 x 8/10	8"/10"		\$36.00
B1TC4301I	23 x 8.50 x 12	12"		\$38.00
B1TC5303I	23 x 9.50/10.50 x 12	12"		\$43.00
B1TC5301I	24 x 12 x 12	12"		\$47.00
B1ATV3227	25 x 13 x 9	9"	A/T Pattern	\$126.00

## Rubber Tie-Down Strap

Chains should be tightened only enough so that they do not come off while in use. If more tension is required, use a rubber strap to secure the outside of the chain.



Part No.	Length	Price
B1SB1745	9"	\$1.80
B1SB1746	15"	\$2.50
B1SB9090	25"	\$3.10
B1SB9091	31"	\$3.70

**FRACTIONAL HORSPOWER (FHP) BELTS – STANDARD AND KEVLAR ( 2L – 3L – 4L – 5L )**  
**CONVENTIONAL ( A – B – C – D – E )**  
**CONVENTIONAL KEVLAR CORD ( A – B – C )**  
**NARROW WEDGE ( 3V – 5 V – 8V )**  
**KEVLAR CORD NARROW WEDGE ( 8V )**  
**CONVENTIONAL RAW EDGE COGGED ( AX – BX – CX )**  
**NARROW WEDGE RAW EDGE COGGED ( 3VX – 5 VX – 8 VX )**  
**DOUBLE SIDED ( AA – BB- CC )**  
**BANDED CONVENTIONAL ( RA – RAX – RB – RBX – RC – RCX – RD )**  
**KEVLAR BANDED CONVENTIONAL ( RBK – RCK )**  
**BANDED NARROW WEDGE ( 3V – 5 V – 8 V )**  
**BANDED COGGED NARROW WEDGE ( 3VX – 5 VX )**  
**BANDED METRIC NARROW WEDGE ( RSPA – RSPB – RSPC )**  
**BANDED NARROW WEDGE KEVLAR ( R3VK – R5VK – R8VK )**  
**METRIC NARROW WEDGE ( SPZ – SPA – SPB – SPC )**  
**METRIC COGGED NARROW WEDGE ( XPZ – XPA – XPB – XPC )**  
**VARIABLE SPEED**  
**POLYVEE ( J – L – M )**  
**TIMING ( MXL – L – H – XH – XXH )**  
**DUAL SIDED TIMING ( DXL – DL – DH – DXH )**  
**HTD/RPP METRIC TIMING ( 3M – 5M – 8M – 14M – 20M )**  
**DUAL SIDED HTD/RPP METRIC TIMING ( D3M – D5M – D8M – D14M – S 20M )**  
**STS/STD SUPER TORQUE METRIC TIMING ( S2M – S3M – S4.5M – S5M – S8M – S14M )**  
**DUAL SIDED STS/STD SUPER TORQUE METRIC TIMING ( DS3M – DS5M – DS8M – DS14M )**  
**POLYURETHANE METRIC TIMING ( T2.5 – T5 – T10 )**  
**POLYURETHANE METRIC TIMING ( AT5 – AT10 )**  
**DUAL SIDED POLYURETHANE METRIC TIMING ( DT5 – DT10 )**  
**POLYMAX ( 3M – 5M – 7M – 11M )**  
**BANDED POLYMAX ( 5M – 7M – 11M )**  
**EUROPEAN METRIC VARIABLE SPEED**  
**ROULANDS METRIC VARIABLE SPEED**  
**SNOWMOBILE BELTS**  
**VINTAGE SNOWMOBILE BELTS**  
**SAW BELTS**  
**ATV/UTV BELTS**  
**GO CART BELTS**  
**MILLING MACHINE BELTS**

*IF A BROKEN BELT CAN NOT BE REPLACED IN A SHORT PERIOD OF TIME IT COULD CAUSE UNNECESSARY AND COSTLY DOWNTIME!  
TO AVOID INVALUABLE LOSS OF PRODUCTION TIME, CALL JAYDEE ENTERPRISES INC. FOR ALL OF YOUR BELT REQUIREMENTS.*

*ARE YOU IN THE CLEVELAND AREA? WE HAVE COUNTER SERVICE – BRING YOUR BELT IN AND WE'LL DO OUR BEST TO MATCH IT AND GET YOU A  
COST EFFECTIVE REPLACEMENT!*

*IF WE DON'T HAVE THE BELT YOU NEED IN STOCK IT CAN BE ADDED TO OUR COMPREHENSIVE INVENTORY! CALL TODAY AND ASK FOR PRICES  
AND LITERATURE. MOST CATALOGS ARE AVAILABLE ON LINE, HARDBACK OR ON CD!*



3465 LOST NATION RD UNIT #15, WILLOUGHBY, OH 44094  
 PHONE (440) 946-9367 – (800) 989-0162 FAX (440) 946-6148  
 E-MAIL: [SALES@JDV-BELTS.COM](mailto:SALES@JDV-BELTS.COM) OR VISIT OUR WEBSITE: [WWW.JDV-BELTS.COM](http://WWW.JDV-BELTS.COM)